

High capacity DC cut-off Relays
EP RELAYS

Product Catalog

**IN Your
Future**

EP RELAYS

High capacity of Max. 1,000 V DC Cut-off possible

Protective construction : Sealed capsule type

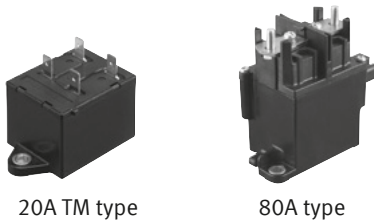

20A TM type

80A type

FEATURES

- High DC voltage, high-current control capable
1,000 V DC switching and cut-off has been achieved
- Compact and low operating sound
- Capsule contact mechanism
Free from outside influence, high contact reliability, superior safety, and arc space unnecessary
- Mounting direction is not specified

TYPICAL APPLICATIONS

- Photovoltaic power generation systems
- Battery charge and discharge control
- Cogeneration systems
- Inverter
- Electric discharge machine and welding equipment
- Elevator

ORDERING INFORMATION (PART NO.)

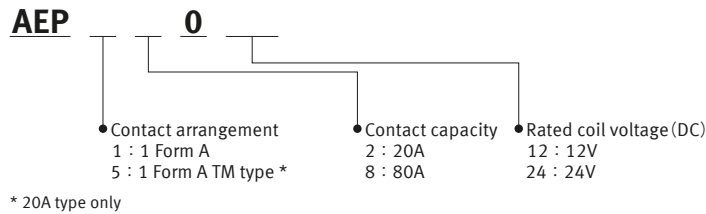

TYPES

Contact arrangement	Contact rating	Terminal type	Rated coil voltage	Part No.	Packing	
					Inner carton	Outer carton
1 Form A	20 A	TM type	12 V DC	AEP52012	25 pcs.	50 pcs.
			24 V DC	AEP52024		
	80 A	Connector type*	12 V DC	AEP18012	1 pc.	20 pcs.
			24 V DC	AEP18024		

* One female connector lead wire for connecting is packaged with the 80 A connector type.

[Specifications]

Housing: Yazaki 7283-1020 (light gray)

Lead wire: 0.5 mm² dia. and 300 ±10 mm length

Lead wire coating color: Pin No. 1: white; Pin No. 2: green

High capacity DC cut-off Relays EP RELAYS

RATING

Coil data

- Operating characteristics such as " Operate voltage " and " Release voltage " are influenced by mounting conditions or ambient temperature, etc.
Therefore, please use the relay within $\pm 5\%$ of rated coil voltage.
- " Initial " means the condition of products at the time of delivery.

Type	Rated coil voltage	Operate voltage* (at 20 °C)	Release voltage* (at 20 °C)	Rated operating current ($\pm 10\%$, at 20 °C)	Coil resistance ($\pm 10\%$, at 20 °C)	Rated operating power	Max. allowable voltage
20 A	12 V DC	Max. 75 % V of rated coil voltage (Initial)	Min. 4.17 % V of rated coil voltage (Initial)	327 mA	36.7 Ω	3.9 W	133 % V of rated coil voltage
	24 V DC			163 mA	146.8 Ω		
80 A	12 V DC		Min. 8.3 % V of rated coil voltage (Initial)	353 mA	34 Ω	4.2 W	
	24 V DC			176 mA	136 Ω		

* Square, pulse driver

Note) When using a DC power supply, use one that provides a current capacity leeway of at least 150 % of the rated operating current.

Specifications

Item	Specifications		
	20 A type	80 A type	
Contact data	Contact arrangement	1 Form A	
	Contact material	Copper alloy	Tungsten type and Copper alloy
	Contact rating (resistive)	20 A 400 V DC	80 A 400 V DC
	Max. switching power (resistive)	20,000 W	80,000 W
	Max. switching voltage	1,000 V DC	
	Max. cut-off current	—	800 A 300 V DC (1 cycle) * ³
	Overload cut-off	60 A 400 V DC (Min. 50 cycles) * ³	120 A 400 V DC (Min. 50 cycles) * ³
	Reverse cut-off	−20 A 200 V DC (Min. 100 cycles) * ³	−80 A 200 V DC (Min. 1,000 cycles) * ³
	Max. switching current	20 A DC continuity (3 mm ² Wire) 40 A DC 10 min (3 mm ² Wire) 60 A DC 1 min (3 mm ² Wire)	80 A DC continuity (15 mm ² Wire) 120 A DC 15 min (15 mm ² Wire) 180 A DC 2 min (15 mm ² Wire)
	Min. switching load (reference value) * ¹	1 A 12 V DC	1 A 12 V DC
Contact voltage drop (initial)	Max. 0.2 V (When carrying current is 20 A)	Max. 0.067 V (When carrying current is 20 A)	
Insulation resistance (initial)	Min. 100 M Ω (at 500 V DC, Measured portion is the same as the case of dielectric strength.)		
Dielectric strength (initial)	Between open contacts	2,500 V rms for 1 min (detection current: 10 mA)	
	Between contact and coil	2,500 V rms for 1 min (detection current: 10 mA)	
Coil holding voltage* ⁴	—	50 to 100 % V (at 80 °C)	
Time characteristic (initial)	Operate time	Max. 50 ms at rated coil voltage (at 20 °C, without bounce)	
	Release time	Max. 30 ms at rated coil voltage (at 20 °C, without bounce, without diode)	
Shock resistance	Functional	For ON: 196 m/s ² (half-sine shock pulse: 11 ms, detection time: 10 μ s) For OFF: 98 m/s ² (half-sine shock pulse: 11 ms, detection time: 10 μ s)	
	Destructive	490 m/s ² (half-sine shock pulse: 6 ms)	
Vibration resistance	Functional	10 to 200 Hz acceleration 43 m/s ² constant (detection time: 10 μ s)	
	Destructive	10 to 200 Hz acceleration 43 m/s ² constant (3 directions, each 4 hours)	
Expected life	Mechanical life	Min. 200 \times 10 ³ ope.	
Conditions	Conditions for usage, transport and storage* ²	Ambient temperature: −40 to +80 °C (storage: Max. +85 °C) , Humidity: 5 to 85 % RH (Avoid icing and condensation)	
Unit weight	Approx. 180 g	Approx. 400 g	

*1: This value can change due to the switching frequency, environmental conditions, and desired reliability level, therefore it is recommended to check this with the actual load.

*2: The upper limit of the ambient temperature is the maximum temperature that can satisfy the coil temperature rise value.
Refer to Usage, transport and storage conditions in NOTES.

*3: Conditions: Varistor used for coil surge absorption. Note: if a diode is used the life will be lower.

*4: Coil holding voltage is the coil voltage after 100 ms from the applied rated coil voltage.

Expected electrical life*¹

Conditions: Resistive load

Type	Switching capacity	Number of operations
20 A	10 A 1,000 V DC	Min. 10 ³ ope. (switching frequency: 6 times/min) * ²
	20 A 400 V DC	Min. 3 \times 10 ³ ope. (switching frequency: 6 times/min) * ²
80 A	80 A 400 V DC	Min. 10 ³ ope. (switching frequency: 20 times/min) * ²

*1: Please refer to the reference data for switching and cut-off at 400 V DC and higher.

*2: Conditions: Varistor used for coil surge absorption. Note) if a diode is used the life will be lower

High capacity DC cut-off Relays EP RELAYS

REFERENCE DATA

1-1. Max. switching capacity (20 A type) 1-2. Max. switching capacity (80 A type)

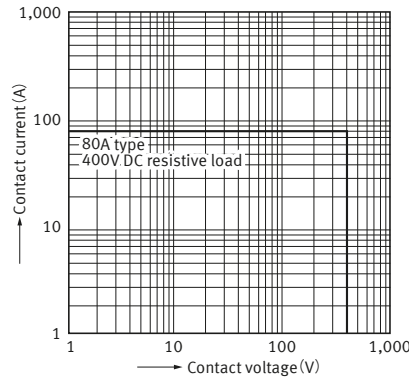
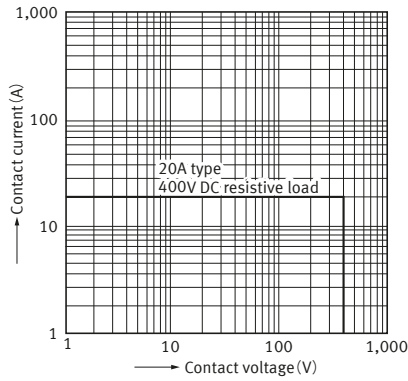

2-1. Switching and cut-off life curve (20 A type)

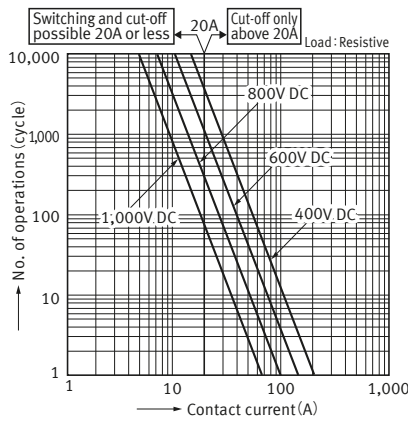

2-2. Switching and cut-off life curve (80 A type)

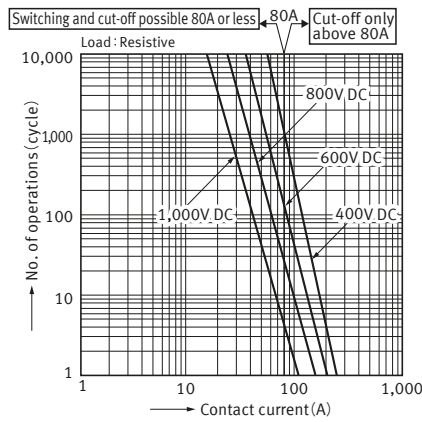

3-1. Ambient temperature characteristic (20 A type: Average)

Tested sample : AEP52012, 3 pcs.

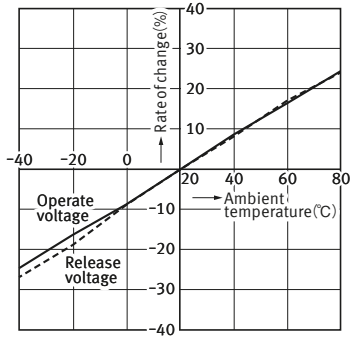

3-2. Ambient temperature characteristics (80 A type: Average)

Tested sample : AEP18012, 3 pcs.

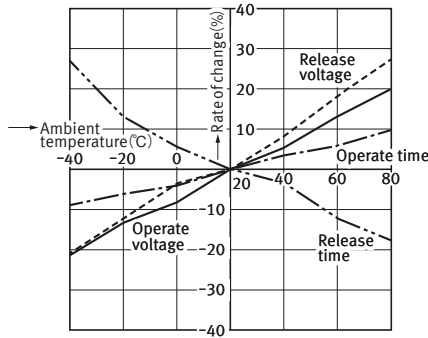

4-1. Carrying performance life curve (20 A type)

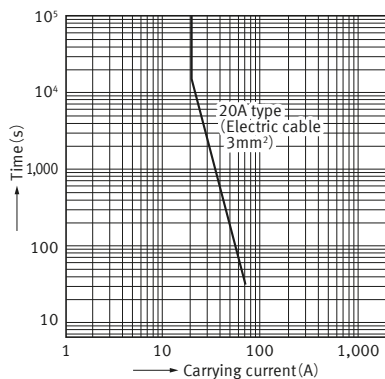

4-2. Carrying performance life curve (80 A type)

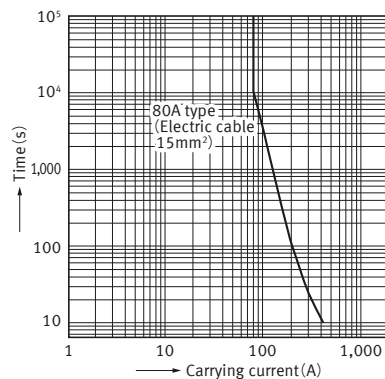

High capacity DC cut-off Relays EP RELAYS

DIMENSIONS (Unit: mm)

CAD The CAD data of the products with a " CAD " mark can be downloaded from our Website.

20 A TM type

CAD

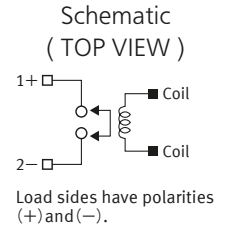
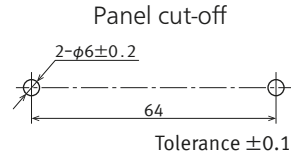
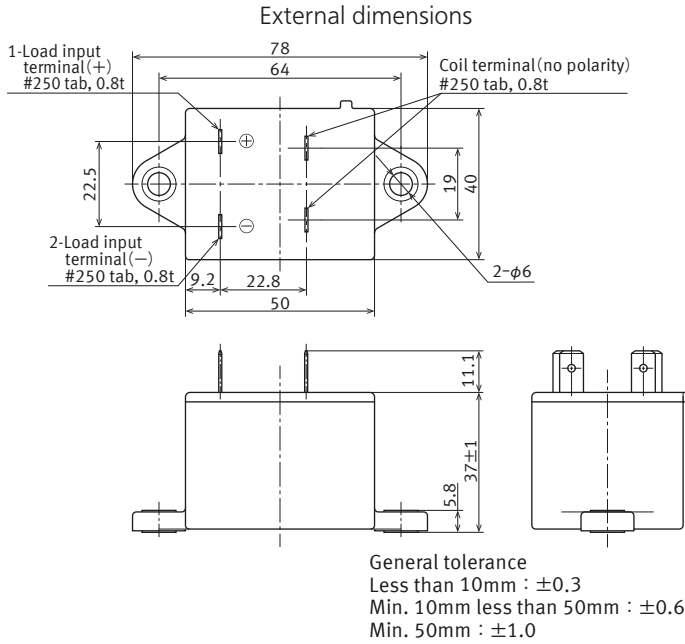

80 A Connector type

CAD

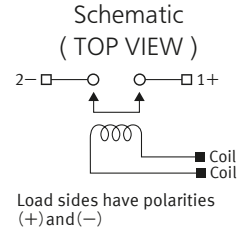
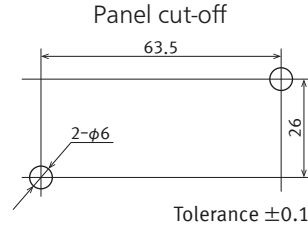
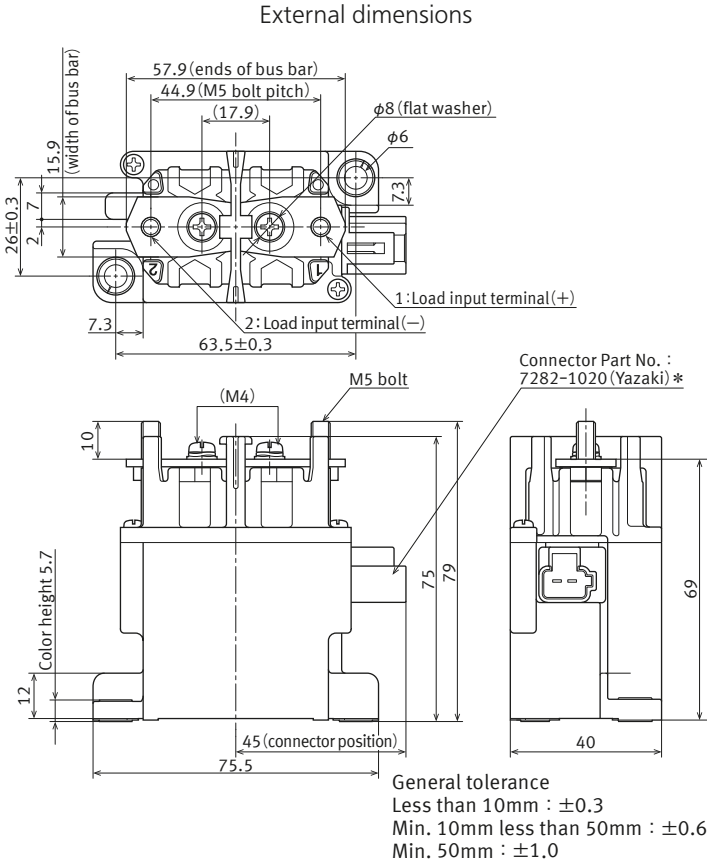

*Accessories (included)

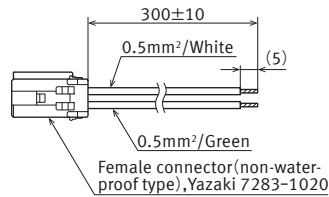

High capacity DC cut-off Relays EP RELAYS

SAFETY STANDARDS

Each standard may be updated at any time, so please check our Website for the latest information.

■ UL/C-UL (Approved)

20 A

File No.	Contact rating
E43149	20 A 400 V DC, 20 A 277 V AC Resistive (UL only)

80 A

File No.	Contact rating
E43149	80 A 400 V DC, 80 A 277 V AC Resistive

■ CSA (Approved)

CSA standard certified by C-UL

GUIDELINES FOR USAGE

■ For cautions for use, please read " GUIDELINES FOR RELAY USAGE ".
https://industrial.panasonic.com/ac/e/control/relay/cautions_use/index.jsp

■ Cautions for usage of EP relays

- Make sure the power is turned off when wiring.
- Incorrect wiring may cause unexpected malfunction and failure.
- The contacts of the relay are polarized. Please follow instructions in the connection schematic when connecting the contacts.
- Don't exceed maximum coil voltage. Exceeding maximum allowable coil voltage on continuous basis will damage the relay and could cause failure.
- If you will be using with a load voltage that exceeds 400 V DC, please be sure to verify operation on the actual device, referring to the switching life curves (reference data) . You must absolutely avoid continual use in which the load current exceeds the rated value. This will cause abnormal heating.
- Condensation will occur during sudden temperature changes in hot and humid environments. Caution is required, because condensation will cause a decrease in the insulation resistance between the terminals.
- Pure DC current should be applied to the coil. If it includes ripple, the ripple factor should be less than 5 %. However, check the actual circuit since the characteristics may be slightly different. The power supply waveform supplied to the coil should be rectangular.
- Do not use a relay if it has been dropped.
- The rated control capacity and life are given as general guides. It is important to conduct sufficient tests on the actual device, because contact properties and working life will differ considerably depending on the type of load and conditions.
- Do not disassemble the relay. Please note that disassembling the relay will invalidate the warranty.
- Avoid mounting the relay in strong magnetic fields (near a transformer or magnet) or close to an object that radiates heat.
- Please note that if the 80 A type is used only with excessive load, the contact resistance may possibly increase.

● Electrical life

This relay is a DC high-voltage switch. In its final breakdown mode, it may lose the ability to provide the proper cut-off. Therefore, do not exceed the indicated switching capacity and life. (Please treat the relay as a product with limited life and replace it when necessary.) In the event that the relay loses cut-off ability, there is a possibility that burning may spread to surrounding parts, so configure the layout so that the power is turned off within one second and from the point of view of safety, consider installing a failsafe circuit in the device. Also, in order to avoid increased contact resistance, do not operate when there is no switching load.

- If the power is turned off and then immediately on after applying the rated voltage (current) continuously to the relay's coil and contact, the resistance of the coil will increase due to a rise in the coil temperature. This causes the release voltage to rise, and possibly exceed the rated release voltage. In these circumstances, take measures such as reducing the load current, limiting the duration of current flow, and applying a coil voltage higher than the rated operating voltage.
- Main contact ratings in the ratings apply to when there is a resistive load. If you are using an inductive load (L load) such that $L/R > 1$ ms, add surge protection in parallel with the inductive load. If this is not done, the electrical life will decrease and cut-off failure may occur. In order to prevent contact welding when using a capacitive load (C load) such as a capacitor load, please make the inrush current setting more than two times that of the rated current. Please consult us for more information.
- Be careful that foreign matter and oils and fats kind don't stick to the main terminal parts because it is likely to cause terminal parts to give off unusual heat. Also, please use the following materials for connected harnesses and bus bars.

Faston terminal for tab terminal
 (JIS C 2809-1999 compliant, flat type connection terminal)

20 A TM type	#250, 0.8 mm board thickness
--------------	------------------------------

Harness nominal cross-sectional area

Load input terminal side	20 A TM type	Min. 3 mm ²
	80 A type	Min. 15 mm ²
Coil input terminal side	20 A TM type	Min. 0.3 mm ²

- We recommend installing a surge protector varistor. Please note that when using a diode, the switching speed may decrease and cause a reduction in cut-off performance.
- Recommend varistor
- | | |
|------------------------|-----------------------------------|
| Amount of proof energy | Min. 1 J |
| Varistor voltage | 1.5 to 3.0 times of rated voltage |
- Regarding AC cutoff, although there is no contact polarity, generally it is thought that the electrical life will shorten due to cutoff in the reverse direction, compared to DC cutoff. Confirm electrical life using actual load. In the case of DC cut-off, please note the contact polarity.

High capacity DC cut-off Relays EP RELAYS

- Permeation life of internal gas
This relay uses a hermetically encased contact (capsule contact) with gas inside. The gas has a permeation life that is affected by the temperature inside the capsule contact (ambient temperature + temperature rise due to flow of electrical current) . Therefore, please do not exceed the operation ambient and storage ambient temperatures given in the specifications
- Use 40 to 70 N or 40 to 80 N of force as a guide to fasten the faston terminal connected to the 20 A TM type. Please use caution when inserting or removing the faston terminal as the relay tab terminal may cause injury. Also, unstable conductivity and abnormal terminal heating may occur; therefore, please check that there is no deformation of or foreign objects on the faston terminals (blade receptacle) you will be connecting.
Use JIS C 2809 (or IEC60760) certified products.

● Mounting

- When installing the relay, always use washers to prevent the screws from loosening.
- Tighten each screw within the rated range given below. Exceeding the maximum torque may result in breakage. Mounting is possible in either direction.

Main unit mounting section

M5 screw	20 A, 80 A	3 to 4 N·m
----------	------------	------------

Load side terminals

80 A	M5 bolt	3.5 to 6.5 N·m
------	---------	----------------

● Connector type

When wiring, please note that the tensile strength of the female connector lead wire used for connection that comes with the 80 A connector type should be max. 10 N. In addition, please avoid the following wiring to prevent failure.

- bending from coil input terminal
 - continuous load to the coil lead wire after wiring
- Also, please insert the female connector deeply and make sure the connection is secure.

- For cautions for use, please read " GUIDELINES FOR RELAY USAGE ".
https://industrial.panasonic.com/ac/e/control/relay/cautions_use/index.jsp

Precautions for Coil Input

■ Long term current carrying

A circuit that will be carrying a current continuously for long periods without relay switching operation. (circuits for emergency lamps, alarm devices and error inspection that, for example, revert only during malfunction and output warnings with form B contacts) Continuous, long-term current to the coil will facilitate deterioration of coil insulation and characteristics due to heating of the coil itself. For circuits such as these, please use a magnetic-hold type latching relay. If you need to use a single stable relay, use a sealed type relay that is not easily affected by ambient conditions and make a failsafe circuit design that considers the possibility of contact failure or disconnection.

■ DC Coil operating power

Steady state DC current should be applied to the coil. The wave form should be rectangular. If it includes ripple, the ripple factor should be less than 5 %. However, please check with the actual circuit since the electrical characteristics may vary. The rated coil voltage should be applied to the coil and the set/reset pulse time of latching type relay differs for each relays, please refer to the relay's individual specifications.

■ Coil connection

When connecting coils of polarized relays, please check coil polarity (+ , -) at the internal connection diagram (Schematic). If any wrong connection is made, it may cause unexpected malfunction, like abnormal heat, fire and so on, and circuit do not work. Avoid impressing voltages to the set coil and reset coil at the same time.

■ Maximum allowable voltage and temperature rise

Proper usage requires that the rated coil voltage be impressed on the coil. Note, however, that if a voltage greater than or equal to the maximum continuous voltage is impressed on the coil, the coil may burn or its layers short due to the temperature rise. Furthermore, do not exceed the usable ambient temperature range listed in the catalog.

● Operate voltage change due to coil temperature rise

In DC relays, after continuous passage of current in the coil, if the current is turned OFF, then immediately turned ON again, due to the temperature rise in the coil, the operate voltage will become somewhat higher. Also, it will be the same as using it in a higher temperature atmosphere. The resistance/temperature relationship for copper wire is about 0.4 % for 1 °C, and with this ratio the coil resistance increases. That is, in order to operate of the relay, it is necessary that the voltage be higher than the operate voltage and the operate voltage rises in accordance with the increase in the resistance value. However, for some polarized relays, this rate of change is considerably smaller.

Ambient Environment

Usage, Transport, and Storage Conditions

During usage, storage, or transportation, avoid locations subjected to direct sunlight and maintain normal temperature, humidity and pressure conditions.

Temperature/Humidity/Pressure

When transporting or storing relays while they are tube packaged, there are cases the temperature may differ from the allowable range. In this case be sure to check the individual specifications.

Also allowable humidity level is influenced by temperature, please check charts shown below and use relays within mentioned conditions. (Allowable temperature values differ for each relays, please refer to the relay's individual specifications.)

1) Temperature:

The tolerance temperature range differs for each relays, please refer to the relay's individual specifications

2) Humidity: 5 to 85 % RH

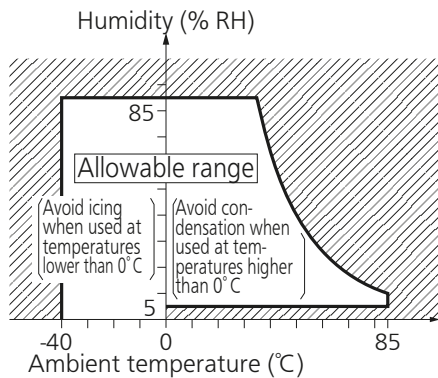

3) Pressure: 86 to 106 kPa

Dew condensation

Condensation occurs when the ambient temperature drops suddenly from a high temperature and humidity, or the relay is suddenly transferred from a low ambient temperature to a high temperature and humidity.

Condensation causes the failures like insulation deterioration, wire disconnection and rust etc.

Panasonic Industry Co., Ltd. does not guarantee the failures caused by condensation.

The heat conduction by the equipment may accelerate the cooling of device itself, and the condensation may occur.

Please conduct product evaluations in the worst condition of the actual usage. (Special attention should be paid when high temperature heating parts are close to the device. Also please consider the condensation may occur inside of the device.)

Icing

Condensation or other moisture may freeze on relays when the temperature become lower than 0 °C. This icing causes the sticking of movable portion, the operation delay and the contact conduction failure etc. Panasonic Industry Co., Ltd. does not guarantee the failures caused by the icing.

The heat conduction by the equipment may accelerate the cooling of relay itself and the icing may occur. Please conduct product evaluations in the worst condition of the actual usage.

Low temperature and low humidity

The plastic becomes brittle if the relay is exposed to a low temperature, low humidity environment for long periods of time.

High temperature and high humidity

Storage for extended periods of time (including transportation periods) at high temperature or high humidity levels or in atmospheres with organic gases or sulfide gases may cause a sulfide film or oxide film to form on the surfaces of the contacts and/or it may interfere with the functions. Check out the atmosphere in which the units are to be stored and transported.

Package

In terms of the packing format used, make every effort to keep the effects of moisture, organic gases and sulfide gases to the absolute minimum.

Silicon

When a source of silicone substances (silicone rubber, silicone oil, silicone coating materials and silicone filling materials etc.) is used around the relay, the silicone gas (low molecular siloxane etc.) may be produced.

This silicone gas may penetrate into the inside of the relay. When the relay is kept and used in this condition, silicone compound may adhere to the relay contacts which may cause the contact failure. Do not use any sources of silicone gas around the relay (Including plastic sealed types).

NOx Generation

When relay is used in an atmosphere high in humidity to switch a load which easily produces an arc, the NOx created by the arc and the water absorbed from outside the relay combine to produce nitric acid.

This corrodes the internal metal parts and adversely affects operation.

Avoid use at an ambient humidity of 85 % RH or higher (at 20 °C). If use at high humidity is unavoidable, please contact our sales representative.

Others

■ Cleaning

- Although the environmentally sealed type relay (plastic sealed type, etc.) can be cleaned, avoid immersing the relay into cold liquid (such as cleaning solvent) immediately after soldering. Doing so may deteriorate the sealing performance.
- Cleaning with the boiling method is recommended (The temperature of cleaning liquid should be 40 °C or lower). Avoid ultrasonic cleaning on relays. Use of ultrasonic cleaning may cause breaks in the coil or slight sticking of the contacts due to ultrasonic energy.

Please refer to "**the latest product specifications**" when designing your product.

- Requests to customers:

<https://industrial.panasonic.com/ac/e/salespolicies/>

■ Global Sales Network Information: industrial.panasonic.com/ac/e/salesnetwork

Panasonic
INDUSTRY

Panasonic Industry Co., Ltd.

Electromechanical Control Business Division

■ 1006, Oaza Kadoma, Kadoma-shi, Osaka 571-8506, Japan
industrial.panasonic.com/ac/e/