



WR-28 Waveguide Voltage Variable Attenuator,
Ka Band, 26.5 GHz to 40 GHz, 0 dB to 30 dB
Attenuation, 1.8 dB Loss, UG-599/U Flange

TECHNICAL DATA SHEET

PEWGA3210

Features

- WR-28 Waveguide Voltage Variable Attenuator
- 26.5 GHz to 40 GHz
- Ka Band
- Insertion Loss: 1.8 dB typ
- Attenuation Range: 0 dB to 30 dB typ
- DC Control Voltage: 0 Vdc to +5 Vdc
- Max RF Input Power (CW) +23 dBm
- 50 Ohm Design
- RF Input and Output Waveguide Flange UG-599/U
- Solder Pins for DC Control Voltage and Ground
- Operational Temperature Range -40°C to +80°C
- Rugged and Compact Aluminum Gold Plated Package Design

Applications

- Test & Measurement
- Military & Commercial Communications
- Military Electronic Systems
- Research & Development

Description

The PEWGA3210 is a WR-28 Waveguide Voltage Variable Attenuator, operating across the Ka Band from 26.5 GHz to 40 GHz. This 50 Ohm design has 1.8 dB typ insertion loss with a maximum (CW) input power handling of +23 dBm. The control voltage is 0 Vdc to +5 Vdc to adjust the attenuation level from 0 dB to 30 dB typ across the full frequency band. The rugged and small size aluminum package design is gold plated and supports a UG-599/U waveguide flange pattern at RF input and output ports. Solder pins are used for DC voltage control and ground. The module operates across a wide temperature range from -40°C to +80°C.

Configuration

Waveguide Flange	WR-28 UG-599/U
Body Material and Plating	Aluminum, Gold

Electrical Specifications Values at 25°C, sea level

Description	Minimum	Typical	Maximum	Units
Frequency Range	26.5		40	GHz
Typical Attenuation Value	0		30	dB
Insertion Loss	1.5	1.8	2.7	dB
Maximum Pin (CW)			23	dBm
Control Voltage	0		5	Vdc

Electrical Notes:

- 1.) Open and short-circuit loads are not recommended at the attenuator output.
- 2.) Ensure proper 50 Ohm load before turning the attenuator "ON".
- 3.) Do not put any foreign objects inside the waveguide. Warranty will be voided.

Click the following link (or enter part number in "SEARCH" on website) to obtain additional part information including price, inventory and certifications: [WR-28 Waveguide Voltage Variable Attenuator, Ka Band, 26.5 GHz to 40 GHz, 0 dB to 30 dB Attenuation, 1.8 dB Loss, UG-599/U Flange PEWGA3210](#)



WR-28 Waveguide Voltage Variable Attenuator,
Ka Band, 26.5 GHz to 40 GHz, 0 dB to 30 dB
Attenuation, 1.8 dB Loss, UG-599/U Flange

TECHNICAL DATA SHEET

PEWGA3210

Biasing Up and Power Down Procedure

Biasing Up Procedure

Step 1	Connect Ground Pin
Step 2	Apply DC Supply Voltage
Step 3	Turn ON RF input

Power Down Procedure

Step 1	Turn OFF RF input
Step 2	Turn OFF DC Supply Voltage
Step 3	Remove Ground

Mechanical Specifications

Description	Flange 1	Waveguide	Flange 2
Interface	UG-599/U	WR-28	UG-599/U

Temperature

Operating Range

-40 to +80 deg C

Storage Range

-40 to +100 deg C

Size

Length

1.5 in [38.1 mm]

Width

1.5 in [38.1 mm]

Height

0.937 in [23.8 mm]

Weight

0.15 lbs [68.04 g]

Compliance Certifications (see [product page](#) for current document)

Plotted and Other Data

Notes:

- Values at 25 °C, sea level

Click the following link (or enter part number in "SEARCH" on website) to obtain additional part information including price, inventory and certifications: [WR-28 Waveguide Voltage Variable Attenuator, Ka Band, 26.5 GHz to 40 GHz, 0 dB to 30 dB Attenuation, 1.8 dB Loss, UG-599/U Flange PEWGA3210](#)



WR-28 Waveguide Voltage Variable Attenuator,
Ka Band, 26.5 GHz to 40 GHz, 0 dB to 30 dB
Attenuation, 1.8 dB Loss, UG-599/U Flange

TECHNICAL DATA SHEET

PEWGA3210

Absolute Maximum Rating

Parameter	Rating
Operating Temperature	-40°C to +80°C
Storage Temperature	-40°C to +100°C
Total Power Dissipation	0.1W
Power Handling (CW)	+23dBm
Control Voltage	+10V

Typical Performance Data

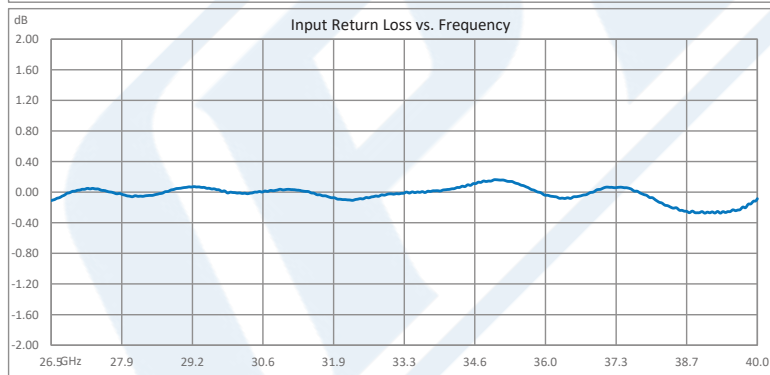
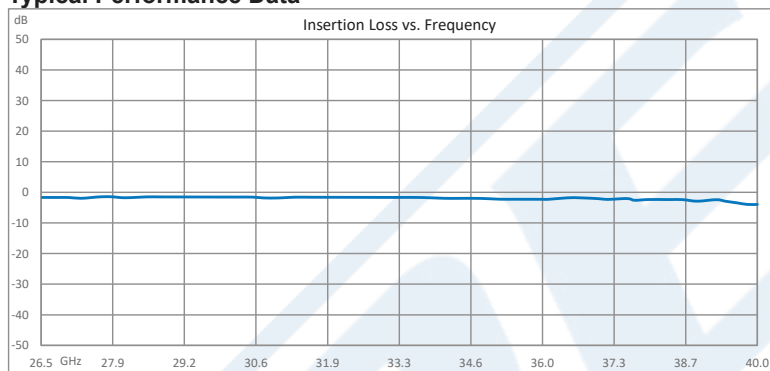

Click the following link (or enter part number in "SEARCH" on website) to obtain additional part information including price, inventory and certifications: [WR-28 Waveguide Voltage Variable Attenuator, Ka Band, 26.5 GHz to 40 GHz, 0 dB to 30 dB Attenuation, 1.8 dB Loss, UG-599/U Flange PEWGA3210](#)



WR-28 Waveguide Voltage Variable Attenuator,
Ka Band, 26.5 GHz to 40 GHz, 0 dB to 30 dB
Attenuation, 1.8 dB Loss, UG-599/U Flange

TECHNICAL DATA SHEET

PEWGA3210

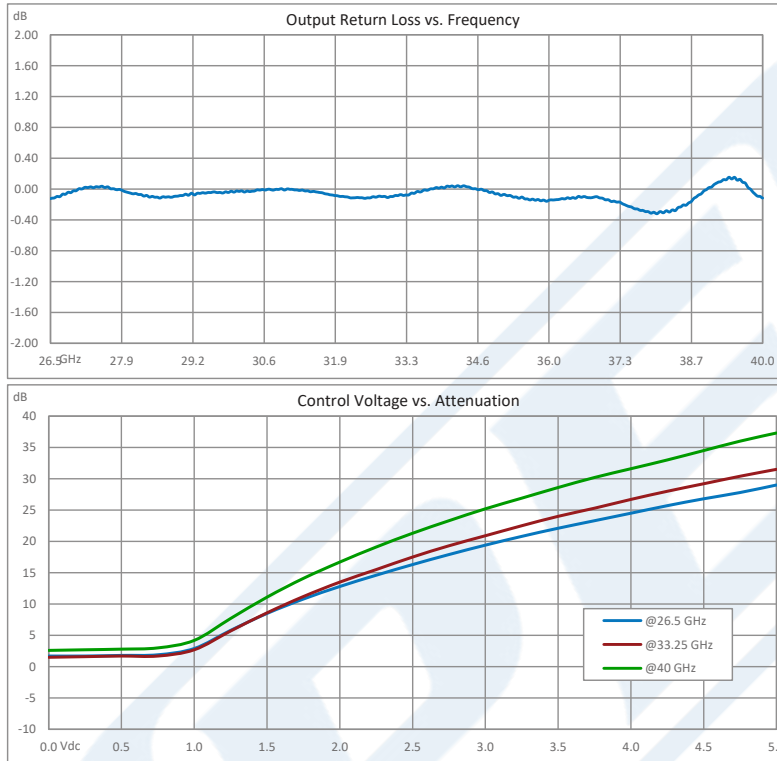

WR-28 Waveguide Voltage Variable Attenuator, Ka Band, 26.5 GHz to 40 GHz, 0 dB to 30 dB Attenuation, 1.8 dB Loss, UG-599/U Flange from Pasternack Enterprises has same day shipment for domestic and International orders. Our RF, microwave and millimeter wave products maintain a 99.4% availability and are part of the broadest selection in the industry.

Click the following link (or enter part number in "SEARCH" on website) to obtain additional part information including price, inventory and certifications: [WR-28 Waveguide Voltage Variable Attenuator, Ka Band, 26.5 GHz to 40 GHz, 0 dB to 30 dB Attenuation, 1.8 dB Loss, UG-599/U Flange PEWGA3210](https://www.pasternack.com/wr-28-waveguide-voltage-variable-attenuator-ka-band-26.5-ghz-to-40-ghz-0-to-30-db-0-to-5-volt-control-ug-599-u-flange-pewga3210-p.aspx)

URL: <https://www.pasternack.com/wr-28-waveguide-voltage-variable-attenuator-ka-band-26.5-ghz-to-40-ghz-0-to-30-db-0-to-5-volt-control-ug-599-u-flange-pewga3210-p.aspx>

The information contained in this document is accurate to the best of our knowledge and representative of the part described herein. It may be necessary to make modifications to the part and/or the documentation of the part, in order to implement improvements. Pasternack reserves the right to make such changes as required. Unless otherwise stated, all specifications are nominal. Pasternack does not make any representation or warranty regarding the suitability of the part described herein for any particular purpose, and Pasternack does not assume any liability arising out of the use of any part or documentation.

PEWGA3210 CAD Drawing

WR-28 Waveguide Voltage Variable Attenuator, Ka Band, 26.5 GHz to 40 GHz, 0 dB to 30 dB Attenuation, 1.8 dB Loss, UG-599/U Flange

REVISIONS			
REV.	DESCRIPTION	DATE	APPROVED
A	INITIAL RELEASE	2/3/2022	TGALLA

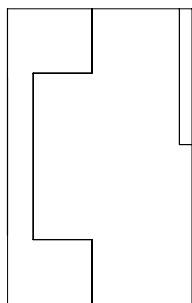

MOUNTING HOLES

2X ϕ .09 [2.3] ∇ .28 [7.0]
4-40 UNC ∇ .25 [6.4]

WR-28
UG-599/U
FLANGE
PATTERN

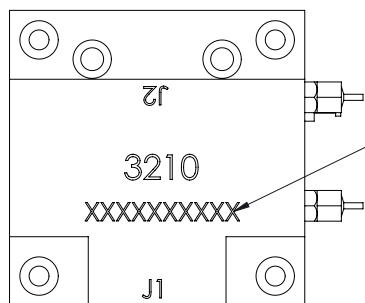

SEE NOTE 1

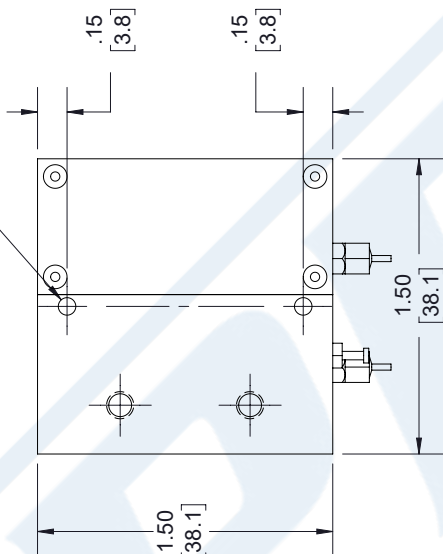

WR-28
UG-599/U
FLANGE
PATTERN

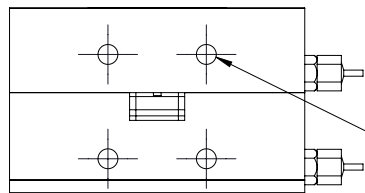

GROUND LUG

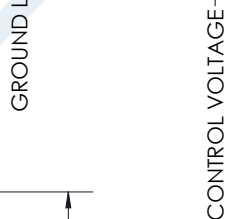
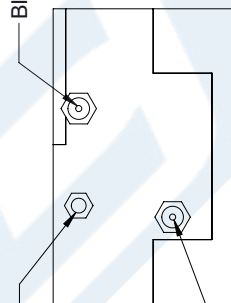

BIAS VOLTAGE

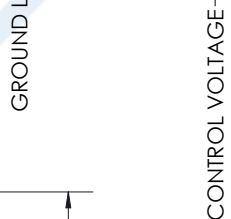

CONTROL VOLTAGE

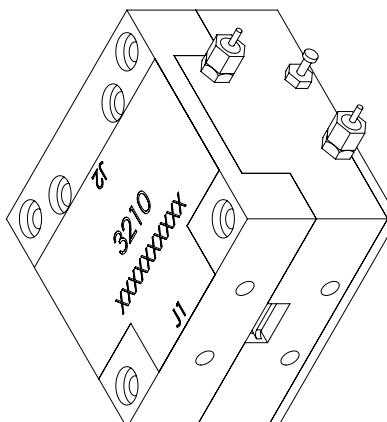

NOTES:

- SERIAL NUMBER AND DATE CODE ARE COMBINED. EX: 202008280001.

THESE COMMODITIES, TECHNOLOGY OR SOFTWARE WERE EXPORTED FROM THE UNITED STATES IN ACCORDANCE WITH THE EXPORT ADMINISTRATION REGULATIONS. DIVERSION CONTRARY TO U.S. LAW PROHIBITED.

UNLESS OTHERWISE SPECIFIED
LEADING DIMENSIONS ARE INCHES
DIMENSIONS IN [] ARE MILLIMETERS

TOLERANCES:

.X = ±.2 [5.08] FRACTIONS
.XX = ±.02 [.51] ±.1/32
.XXX = ±.005 [.13] ANGLES ± 1°

CABLE LENGTH (L) TOLERANCES:

L ≤ 12 [305] = +1 [25] / -0
12 [305] < L ≤ 60 [1524] = +2 [51] / -0
60 [1524] < L ≤ 120 [3048] = +4 [102] / -0
120 [3048] < L ≤ 300 [7620] = +6 [152] / -0
300 [7620] < L = +5%L / -0

ALL DIMENSIONS SHOWN
ARE FOR REFERENCE ONLY.



Pasternack Enterprises, Inc.
P.O. Box 16759, Irvine, CA 92623.
Phone: 1.949.261.1920 | 1.866.727.8376
Fax: 1.949.261.7451
Website: www.pasternack.com
E-mail: sales@pasternack.com



THE INFORMATION AND
DESIGN IN THIS DOCUMENT
IS THE PROPERTY OF
PASTERNAK CORPORATION
ALL RIGHTS RESERVED.

SHEET 1 OF 1
SCALE N/A

SIZE	CAGE CODE	DRAWN BY	ITEM NO.	REV
A	53919	MVEERAPPAN	PEWGA3210	A