

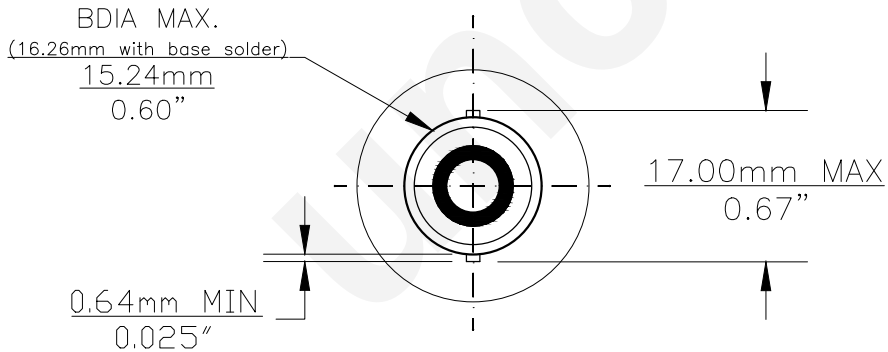

PART NO.	BASE TYPE	DESIGN VOLTS	DESIGN AMPS	MSCD	FILAMENT TYPE	AVERAGE LIFE HOURS	REVISIONS			
							REV #	DESCRIPTION	DATE	APPROVED
7527	S.C. Bayonet (BA15s)	12.0V	1.50±5%	20±15%	C-6	75	1	ISSUED	07/01/2014	R.M.

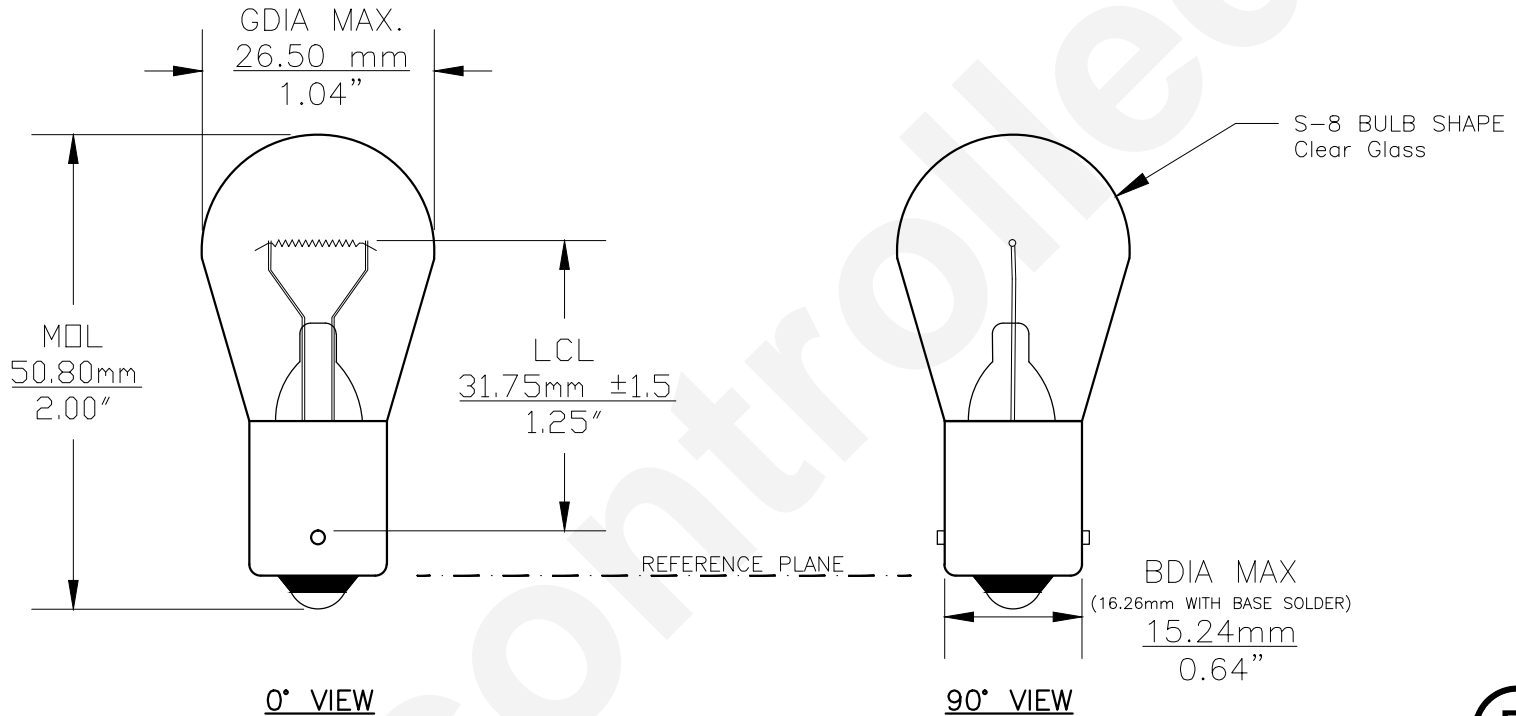

Note: Made according to SAE specifications



UNLESS OTHERWISE SPECIFIED: DIMENSIONS ARE IN INCHES TOLERANCES		CEC INDUSTRIES LTD			
DECIMALS	ANGULAR	599 BOND STREET		LINCOLNSHIRE, IL 60069	
.XX ± .05	± 0.5°	TITLE LIGHT BULB NO. 7527			
.XXX ± .010	± 1/64	SIZE A	FSCM NO.	DWG NO. 7527	REV 1
FRACTIONAL		SCALE	PLOT SCALE	SHEET 1 OF 1	
DRAWN ROSE MEDINA DATE 07/01/2014		MATERIAL FILE 7527.pdf DRAWING NOT TO SCALE			