

STRADA-2X2-TF

Narrow forward throw beam optimized for European tunnels

SPECIFICATION:

| | |
|----------------|----------------|
| Dimensions | 50.0 x 50.0 mm |
| Height | 8.7 mm |
| Fastening | screw |
| ROHS compliant | yes ⓘ |

MATERIALS:

| Component | Type | Material | Colour | Finish |
|---------------|------------|----------|--------|--------|
| STRADA-2X2-TF | Multi-lens | PMMA | clear | |

ORDERING INFORMATION:





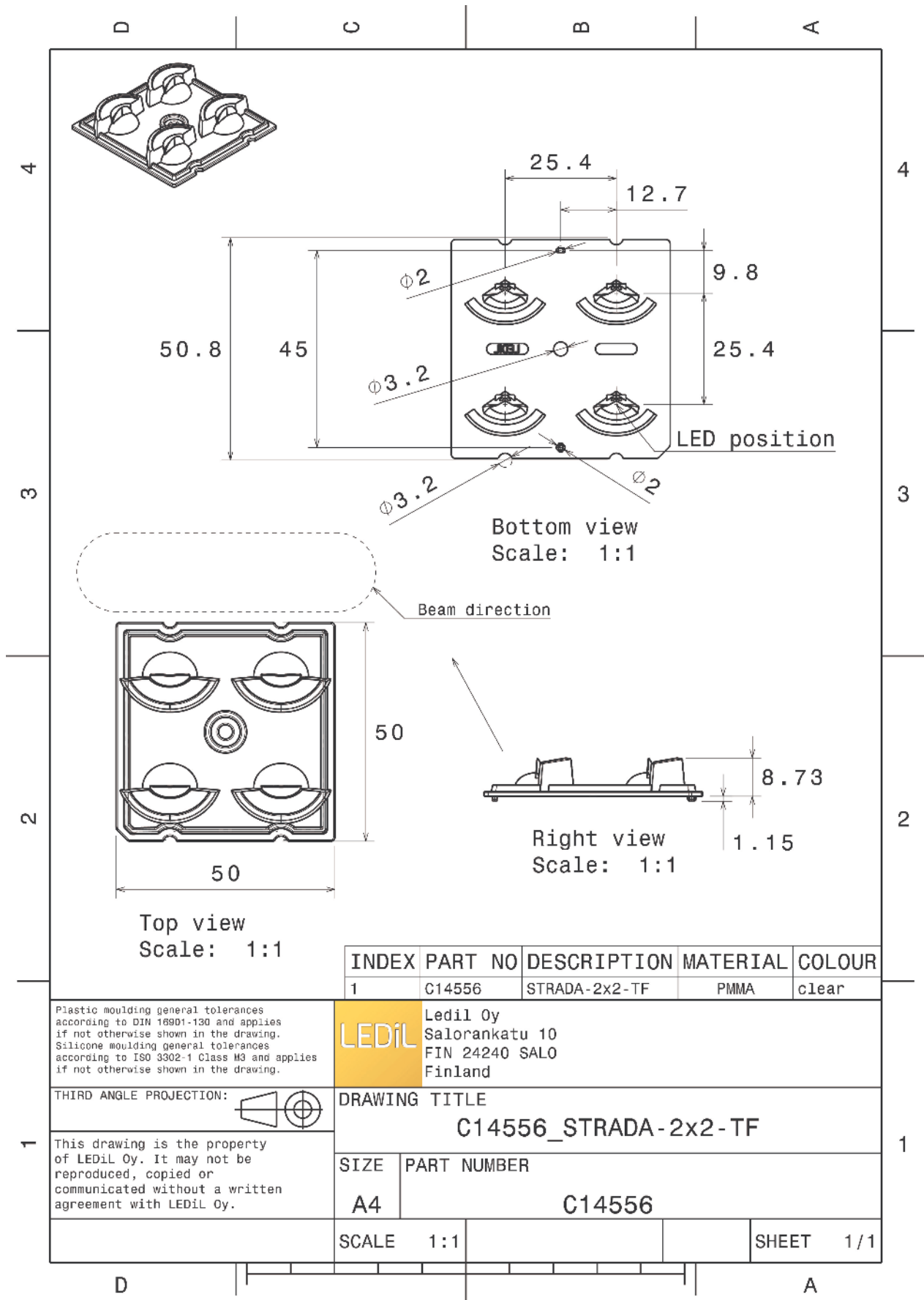

| Component | Qty in box | MOQ | MPQ | Box weight (kg) |
|--|------------|-----|-----|-----------------|
| C14556_STRADA-2X2-TF » Box size: 480 x 280 x 300 mm | 800 | 160 | 160 | 6.5 |



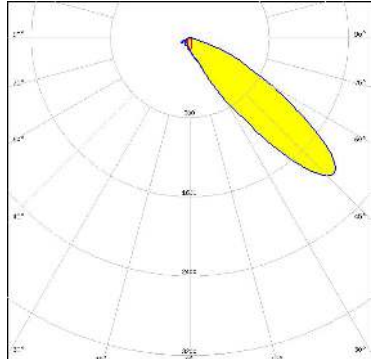

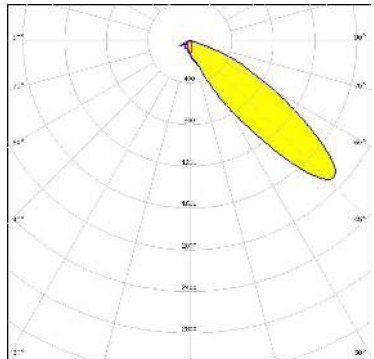
See also our general installation guide: www.ledil.com/installation_guide

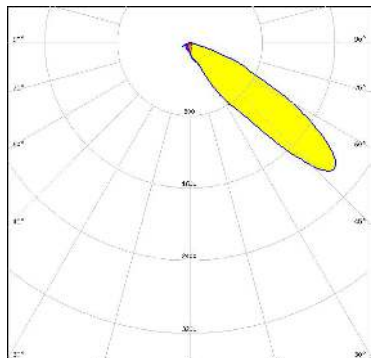
OPTICAL RESULTS (MEASURED):

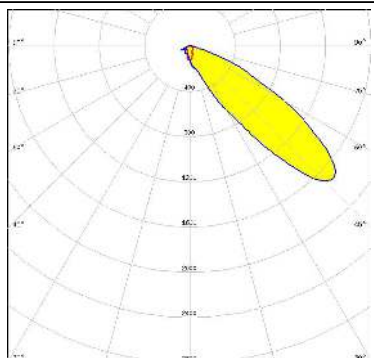
| | |
|--|---|
|  <p> LED QUICK FLUX XTP 2x4 xxx LS G5 FWHM / FWTM Asymmetric Efficiency 94 % Peak intensity 2 cd/m LEDs/each optic 1 Light colour White Required components: </p> |  |
|  <p> LED QUICK FLUX XTP 2x6 xxx LS G5 FWHM / FWTM Asymmetric Efficiency 94 % Peak intensity 1.9 cd/m LEDs/each optic 1 Light colour White Required components: </p> |  |
|  <p> LED XP-G2 FWHM / FWTM Asymmetric Efficiency 94 % Peak intensity 2.1 cd/m LEDs/each optic 1 Light colour White Required components: </p> |  |
|  <p> LED XP-G3 FWHM / FWTM Asymmetric Efficiency 94 % Peak intensity 1.7 cd/m LEDs/each optic 1 Light colour White Required components: </p> |  |

OPTICAL RESULTS (MEASURED):

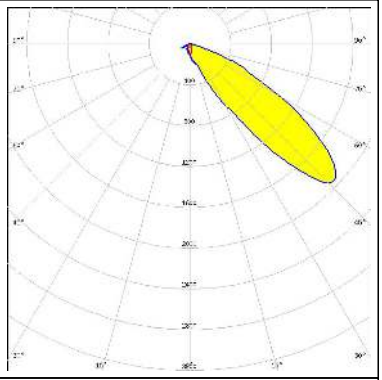
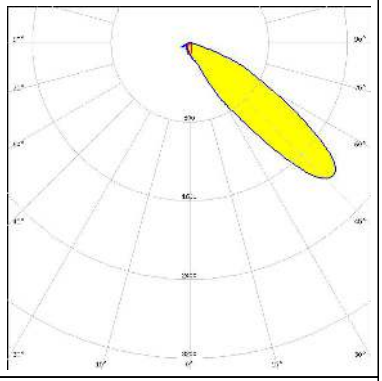
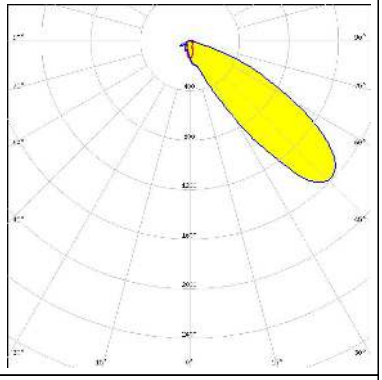
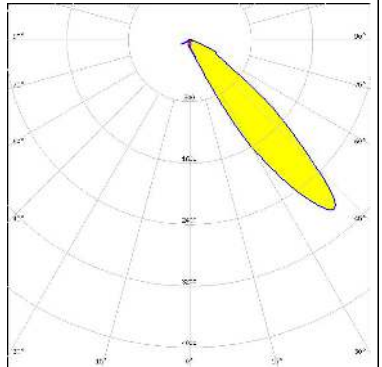
| | |
|--|---|
| <p>LUMILEDS</p> <p>LED LUXEON T</p> <p>FWHM / FWTM Asymmetric</p> <p>Efficiency 94 %</p> <p>Peak intensity 2 cd/lm</p> <p>LEDs/each optic 1</p> <p>Light colour White</p> <p>Required components:</p> |  |
| <p>MST <i>Your solutions</i></p> <p>LED RecLED 122x50mm 1900lm 730 2x4 Opt G1</p> <p>FWHM / FWTM Asymmetric</p> <p>Efficiency 97 %</p> <p>Peak intensity 2 cd/lm</p> <p>LEDs/each optic 1</p> <p>Light colour White</p> <p>Required components:</p> |  |
| <p>NICHIA</p> <p>LED NVSW3x9A</p> <p>FWHM / FWTM Asymmetric</p> <p>Efficiency 94 %</p> <p>Peak intensity 1.6 cd/lm</p> <p>LEDs/each optic 1</p> <p>Light colour White</p> <p>Required components:</p> |  |
| <p>NICHIA</p> <p>LED NVSxE21A</p> <p>FWHM / FWTM Asymmetric</p> <p>Efficiency 94 %</p> <p>Peak intensity 2.9 cd/lm</p> <p>LEDs/each optic 1</p> <p>Light colour White</p> <p>Required components:</p> |  |

OPTICAL RESULTS (MEASURED):

OSRAM

LED PrevaLED Brick HP 2x8
 FWHM / FWTM Asymmetric
 Efficiency 94 %
 Peak intensity 1.2 cd/lm
 LEDs/each optic 1
 Light colour White
 Required components:

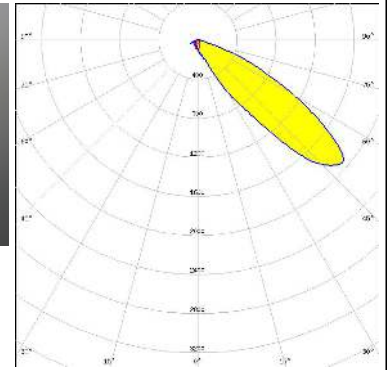
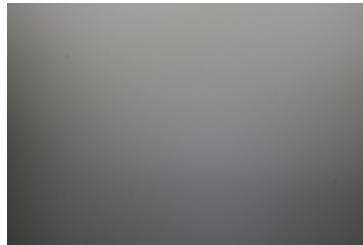

OSRAM

OSRAM Opto Semiconductors
 LED OSLOM Square CSSRM2/CSSRM3
 FWHM / FWTM Asymmetric
 Efficiency 94 %
 Peak intensity 1.2 cd/lm
 LEDs/each optic 1
 Light colour White
 Required components:

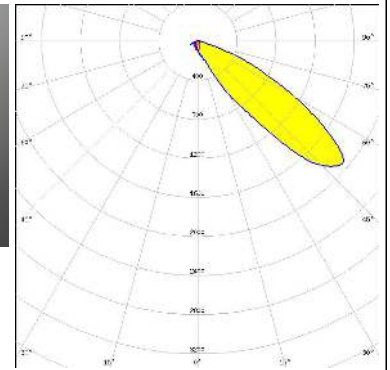
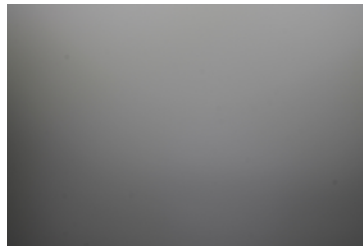

OSRAM

OSRAM Opto Semiconductors
 LED OSLOM Square PC
 FWHM / FWTM Asymmetric
 Efficiency 94 %
 Peak intensity 2.2 cd/lm
 LEDs/each optic 1
 Light colour White
 Required components:

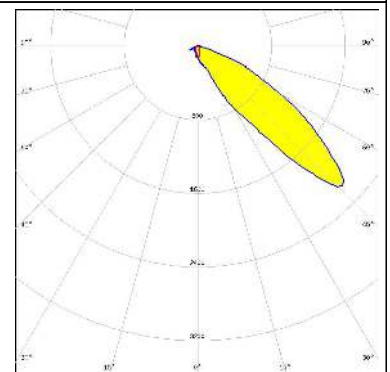

PHILIPS

LED Fortimo FastFlex LED 2x8 DA G4
 FWHM / FWTM Asymmetric
 Efficiency 94 %
 Peak intensity 2.1 cd/lm
 LEDs/each optic 1
 Light colour White
 Required components:

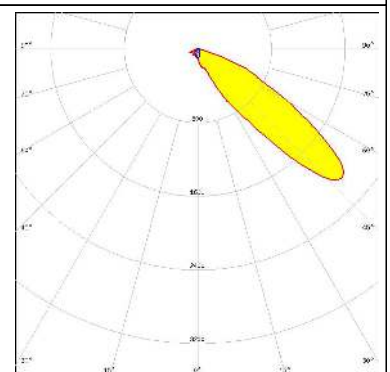

OPTICAL RESULTS (MEASURED):

PHILIPS

LED Fortimo FastFlex LED 2x8 DA G4+
 FWHM / FWTM Asymmetric
 Efficiency 97 %
 Peak intensity 1.7 cd/lm
 LEDs/each optic 1
 Light colour White
 Required components:

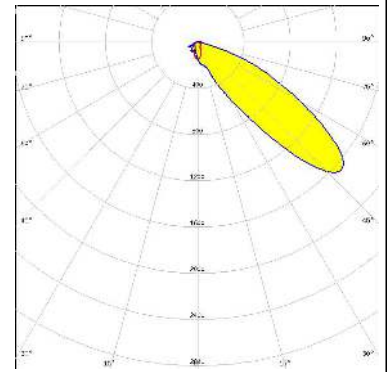

PHILIPS

LED Fortimo FastFlex LED 2x8 DA G5
 FWHM / FWTM Asymmetric
 Efficiency 97 %
 Peak intensity 2.1 cd/lm
 LEDs/each optic 1
 Light colour White
 Required components:

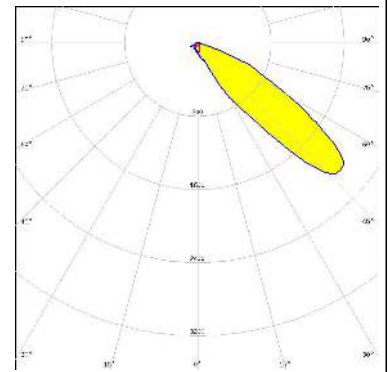

SAMSUNG

LED HiLOM RC12 Z (LH181B)
 FWHM / FWTM Asymmetric
 Efficiency 99 %
 Peak intensity 2.7 cd/lm
 LEDs/each optic 1
 Light colour White
 Required components:

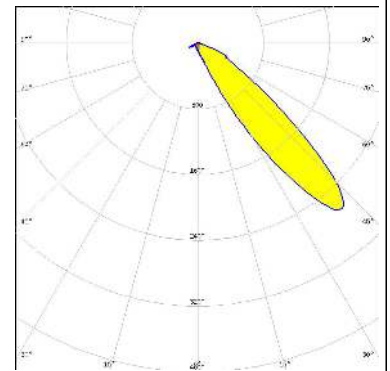

SAMSUNG

LED HiLOM RH12 Z (LH351C)
 FWHM / FWTM Asymmetric
 Efficiency 97 %
 Peak intensity 1.8 cd/lm
 LEDs/each optic 1
 Light colour White
 Required components:

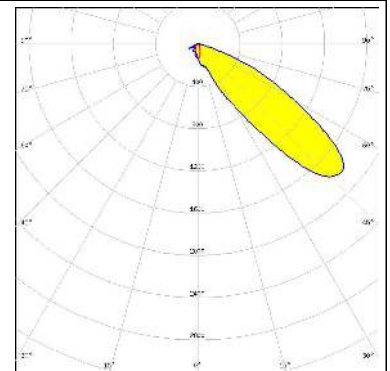

OPTICAL RESULTS (MEASURED):

SAMSUNG

LED HiLOM RH16 (LH351C)
 FWHM / FWTM Asymmetric
 Efficiency 94 %
 Peak intensity 1.8 cd/m
 LEDs/each optic 1
 Light colour White
 Required components:

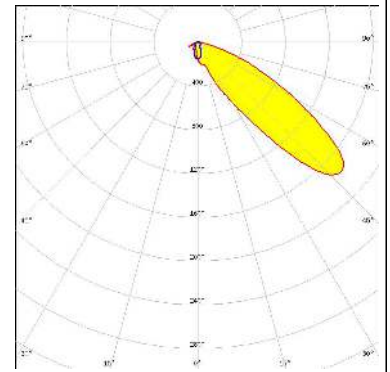

SAMSUNG

LED LH351B
 FWHM / FWTM Asymmetric
 Efficiency 94 %
 Peak intensity 1.6 cd/m
 LEDs/each optic 1
 Light colour White
 Required components:

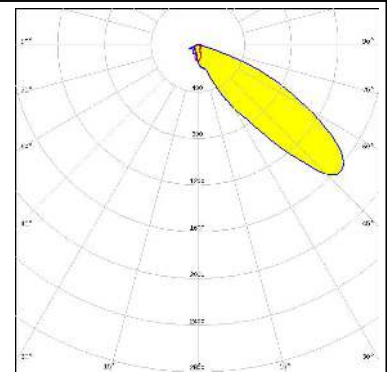



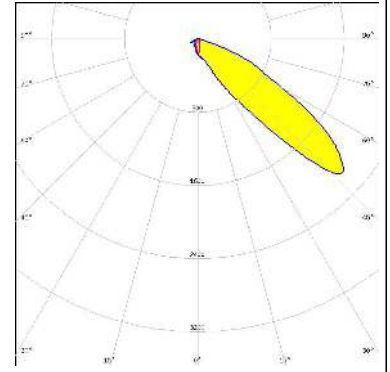

LED LED-Pa-L15c2W11c2-xxx-C050-01
 FWHM / FWTM Asymmetric
 Efficiency 97 %
 Peak intensity 2.2 cd/m
 LEDs/each optic 1
 Light colour White
 Required components:

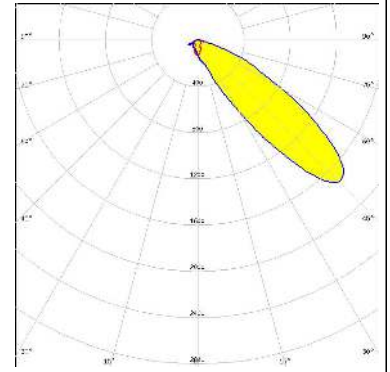

SEMI SEMICONDUCTOR
 LED Z5M3
 FWHM / FWTM Asymmetric
 Efficiency 94 %
 Peak intensity 1.7 cd/m
 LEDs/each optic 1
 Light colour White
 Required components:

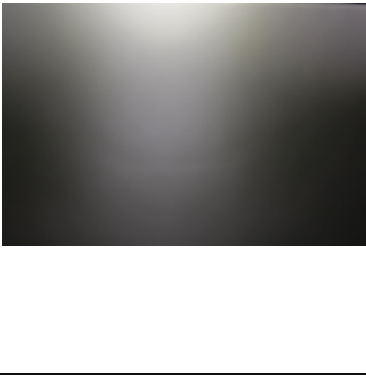
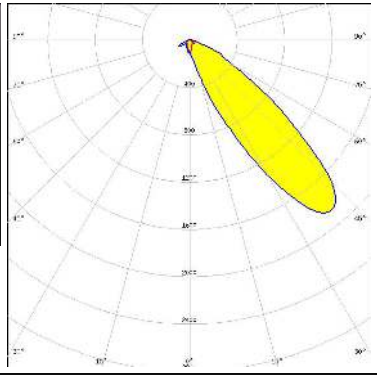

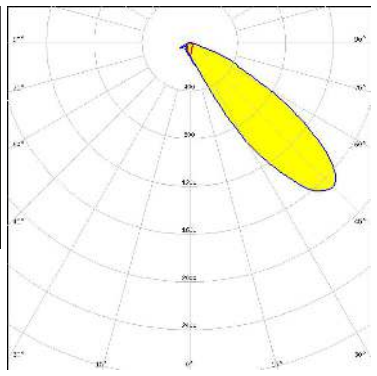
OPTICAL RESULTS (MEASURED):

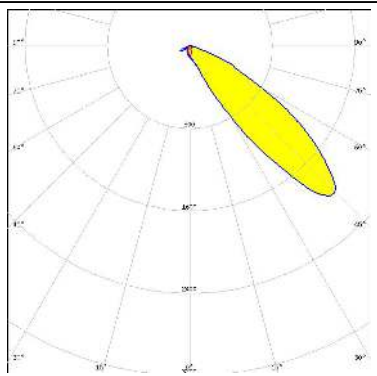
| | | |
|--|--|---|
| <p>SEOUL SEMICONDUCTOR</p> <p>LED Z8Y22</p> <p>FWHM / FWTM Asymmetric</p> <p>Efficiency 94 %</p> <p>Peak intensity 1.9 cd/lm</p> <p>LEDs/each optic 1</p> <p>Light colour White</p> <p>Required components:</p> |  |  |
| <p>SEOUL SEMICONDUCTOR</p> <p>LED Z8Y22P</p> <p>FWHM / FWTM Asymmetric</p> <p>Efficiency 94 %</p> <p>Peak intensity 1.7 cd/lm</p> <p>LEDs/each optic 1</p> <p>Light colour White</p> <p>Required components:</p> |  |  |
| <p>TOSHIBA Leading Innovation >>></p> <p>LED TL1L4</p> <p>FWHM / FWTM Asymmetric</p> <p>Efficiency 91 %</p> <p>Peak intensity 2 cd/lm</p> <p>LEDs/each optic 1</p> <p>Light colour White</p> <p>Required components:</p> |  |  |
| <p>TRIDONIC</p> <p>LED RLE 2x4 2000lm HP EXC2 OTD</p> <p>FWHM / FWTM Asymmetric</p> <p>Efficiency 94 %</p> <p>Peak intensity 2.2 cd/lm</p> <p>LEDs/each optic 1</p> <p>Light colour White</p> <p>Required components:</p> | | |

OPTICAL RESULTS (MEASURED):

TRIDONIC

LED RLE 2x8 4000lm HP EXC2 OTD
 FWHM / FWTM Asymmetric
 Efficiency 94 %
 Peak intensity 2.2 cd/lm
 LEDs/each optic 1
 Light colour White
 Required components:

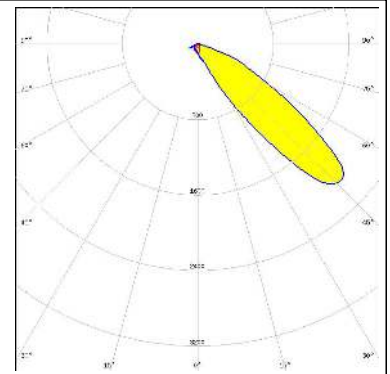

TRIDONIC

LED RLE G1 49x121mm 2000lm xxx EXC OTD
 FWHM / FWTM Asymmetric
 Efficiency 94 %
 Peak intensity 2.1 cd/lm
 LEDs/each optic 1
 Light colour White
 Required components:

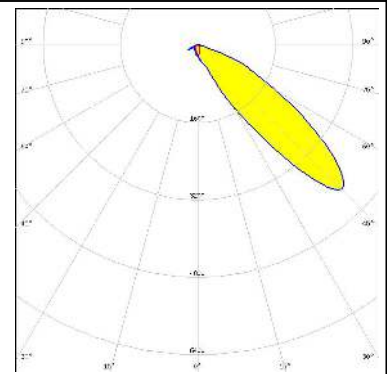

TRIDONIC

LED RLE G1 49x133mm 2000lm xxx EXC OTD
 FWHM / FWTM Asymmetric
 Efficiency 94 %
 Peak intensity 2.1 cd/lm
 LEDs/each optic 1
 Light colour White
 Required components:

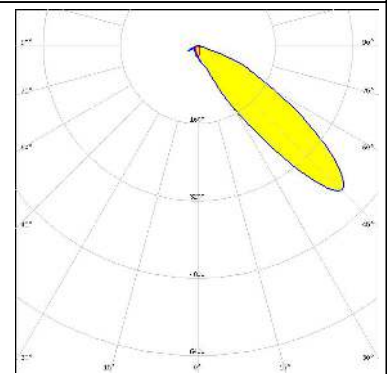

TRIDONIC

LED RLE G1 49x223mm 4000lm xxx EXC OTD
 FWHM / FWTM Asymmetric
 Efficiency 94 %
 Peak intensity 2.1 cd/lm
 LEDs/each optic 1
 Light colour White
 Required components:

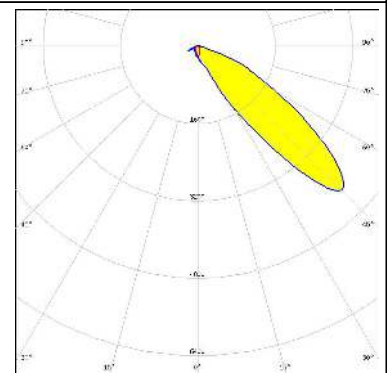

OPTICAL RESULTS (MEASURED):

TRIDONIC

| | |
|----------------------|------------------------------------|
| LED | RLE G1 49x245mm 4000lm xxx EXC OTD |
| FWHM / FWTM | Asymmetric |
| Efficiency | 94 % |
| Peak intensity | 2.1 cd/lm |
| LEDs/each optic | 1 |
| Light colour | White |
| Required components: | |

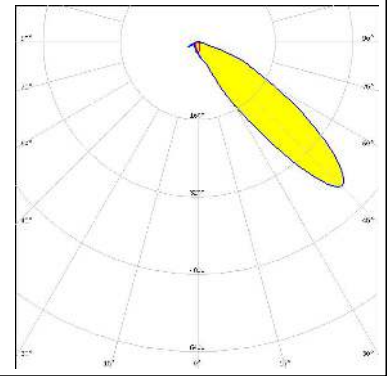

OPTICAL RESULTS (SIMULATED):

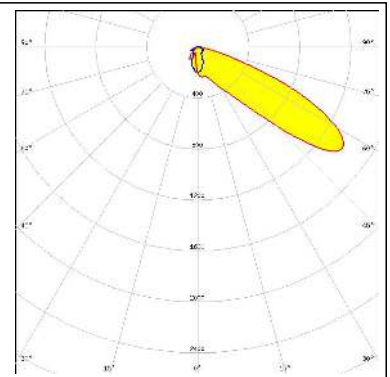
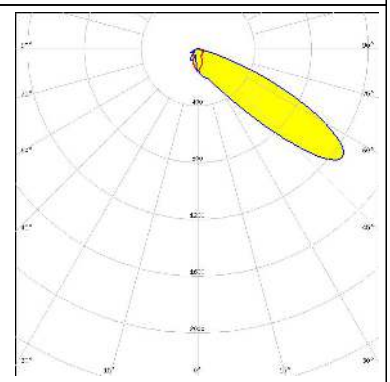
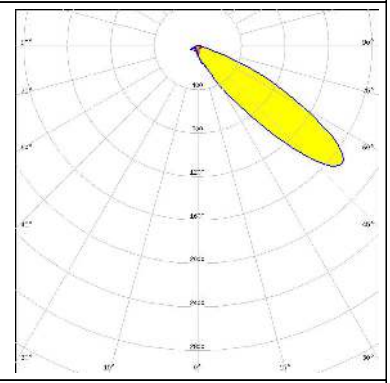
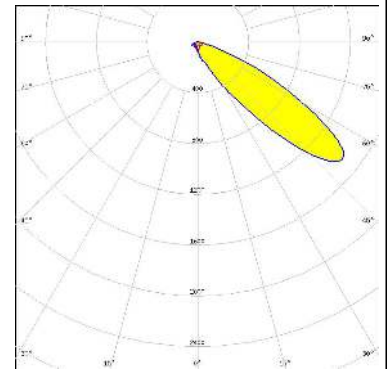
| | |
|--|---|
| <p>CREE → LED</p> <p>LED: XP-G2 HE FWHM / FWTM: Asymmetric Efficiency: 91 % Peak intensity: 1.4 cd/lm LEDs/each optic: 1 Light colour: White Required components:</p> |  |
| <p>CREE → LED</p> <p>LED: XP-G3 FWHM / FWTM: Asymmetric Efficiency: 79 % Peak intensity: 1.3 cd/lm LEDs/each optic: 1 Light colour: White Required components:</p> <p style="background-color: #ADD8E6; padding: 2px;">Protective plate, glass</p> |  |
| <p>CREE → LED</p> <p>LED: XT-E FWHM / FWTM: Asymmetric Efficiency: 92 % Peak intensity: 1.7 cd/lm LEDs/each optic: 1 Light colour: White Required components:</p> |  |
| <p>CREE → LED</p> <p>LED: XT-E FWHM / FWTM: Asymmetric Efficiency: 78 % Peak intensity: 1.5 cd/lm LEDs/each optic: 1 Light colour: White Required components:</p> <p style="background-color: #ADD8E6; padding: 2px;">Protective plate, glass</p> |  |

OPTICAL RESULTS (SIMULATED):

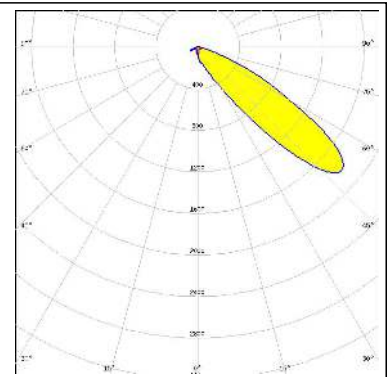
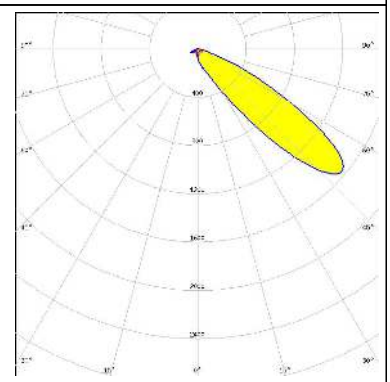
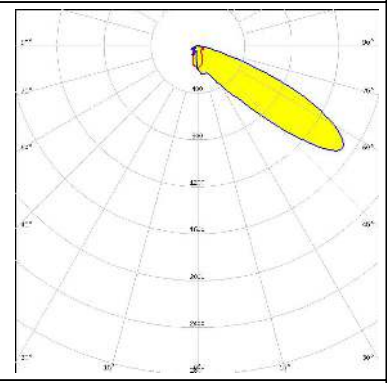
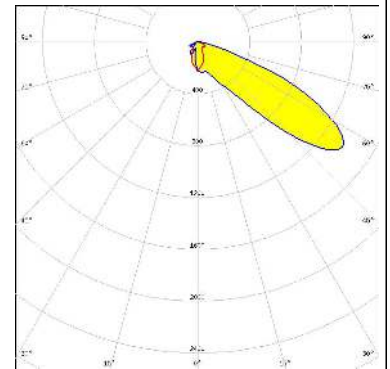
| | |
|---|---|
| <p>LUMILEDS</p> <p>LED LUXEON 3030 2D (Round LES)</p> <p>FWHM / FWTM Asymmetric</p> <p>Efficiency 94 %</p> <p>Peak intensity 1.8 cd/lm</p> <p>LEDs/each optic 1</p> <p>Light colour White</p> <p>Required components:</p> |  |
| <p>LUMILEDS</p> <p>LED LUXEON 3030 2D (Round LES)</p> <p>FWHM / FWTM Asymmetric</p> <p>Efficiency 80 %</p> <p>Peak intensity 1.6 cd/lm</p> <p>LEDs/each optic 1</p> <p>Light colour White</p> <p>Required components:</p> <p>Protective plate, glass</p> |  |
| <p>LUMILEDS</p> <p>LED LUXEON HL2X</p> <p>FWHM / FWTM Asymmetric</p> <p>Efficiency 93 %</p> <p>Peak intensity 1.5 cd/lm</p> <p>LEDs/each optic 1</p> <p>Light colour White</p> <p>Required components:</p> |  |
| <p>LUMILEDS</p> <p>LED LUXEON HL2X-D</p> <p>FWHM / FWTM Asymmetric</p> <p>Efficiency 94 %</p> <p>Peak intensity 1.4 cd/lm</p> <p>LEDs/each optic 1</p> <p>Light colour White</p> <p>Required components:</p> |  |

OPTICAL RESULTS (SIMULATED):

| | |
|--|--|
| <p>LUMILEDS</p> <p>LED: LUXEON HL2X-D</p> <p>FWHM / FWTM: Asymmetric</p> <p>Efficiency: 80 %</p> <p>Peak intensity: 1.2 cd/lm</p> <p>LEDs/each optic: 1</p> <p>Light colour: White</p> <p>Required components:</p> <p>Protective plate, glass</p> | |
| <p>LUMILEDS</p> <p>LED: LUXEON HL2X-P</p> <p>FWHM / FWTM: Asymmetric</p> <p>Efficiency: 93 %</p> <p>Peak intensity: 1.3 cd/lm</p> <p>LEDs/each optic: 1</p> <p>Light colour: White</p> <p>Required components:</p> | |
| <p>LUMILEDS</p> <p>LED: LUXEON XR-HL2X (L2H2-xxxxxxxMLU010)</p> <p>FWHM / FWTM: Asymmetric</p> <p>Efficiency: 94 %</p> <p>Peak intensity: 1.4 cd/lm</p> <p>LEDs/each optic: 1</p> <p>Light colour: White</p> <p>Required components:</p> | |
| <p>LUMILEDS</p> <p>LED: LUXEON XR-HL2X (L2H2-xxxxxxxMLU010)</p> <p>FWHM / FWTM: Asymmetric</p> <p>Efficiency: 80 %</p> <p>Peak intensity: 1.2 cd/lm</p> <p>LEDs/each optic: 1</p> <p>Light colour: White</p> <p>Required components:</p> <p>Protective plate, glass</p> | |

OPTICAL RESULTS (SIMULATED):

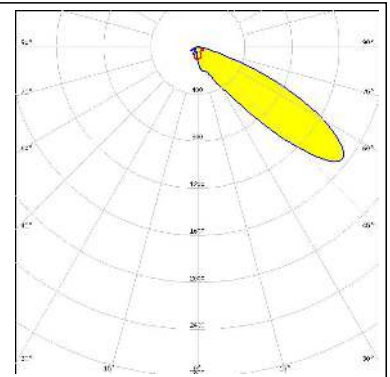
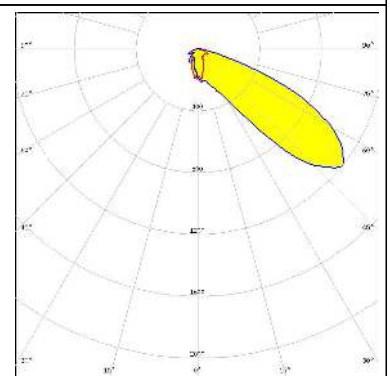
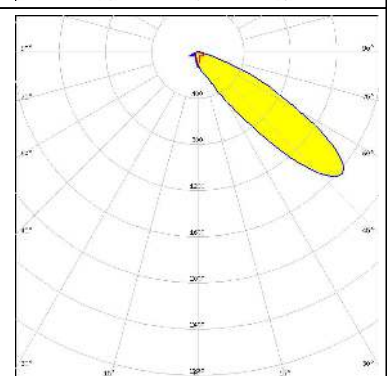
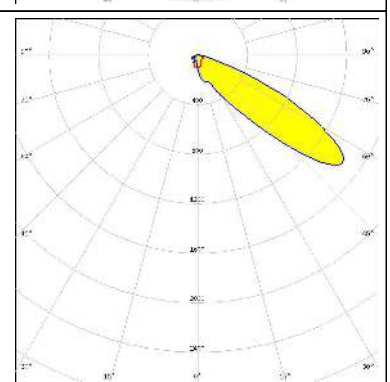
| | |
|--|---|
| <p>NICHIA</p> <p>LED: NVSxx19B/NVSxx19C FWHM / FWTM: Asymmetric Efficiency: 92 % Peak intensity: 1.6 cd/lm LEDs/each optic: 1 Light colour: White Required components:</p> |  |
| <p>NICHIA</p> <p>LED: NWSx229A FWHM / FWTM: Asymmetric Efficiency: 92 % Peak intensity: 1.2 cd/lm LEDs/each optic: 1 Light colour: White Required components:</p> |  |
| <p>OSRAM <small>Opto Semiconductors</small></p> <p>LED: OSCONIQ P 3737 Flat FWHM / FWTM: Asymmetric Efficiency: 94 % Peak intensity: 1.6 cd/lm LEDs/each optic: 1 Light colour: White Required components:</p> |  |
| <p>OSRAM <small>Opto Semiconductors</small></p> <p>LED: OSOLON Square CSSRM2/CSSRM3 FWHM / FWTM: Asymmetric Efficiency: 84 % Peak intensity: 1.5 cd/lm LEDs/each optic: 1 Light colour: White Required components:</p> <p style="background-color: #ADD8E6; padding: 2px;">Protective plate, glass</p> |  |

OPTICAL RESULTS (SIMULATED):

PHILIPS

LED Fortimo FastFlex LED 2x8 DAX G4
 FWHM / FWTM Asymmetric
 Efficiency 93 %
 Peak intensity 1.4 cd/lm
 LEDs/each optic 1
 Light colour White
 Required components:

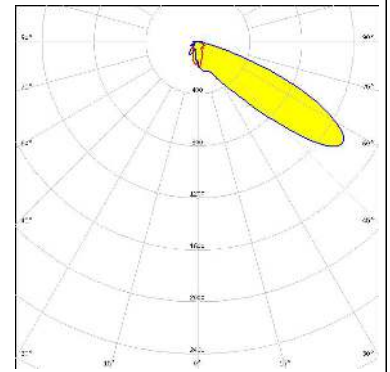

SAMSUNG

LED HiLOM RH12 Z (LH351C)
 FWHM / FWTM Asymmetric
 Efficiency 85 %
 Peak intensity 1.6 cd/lm
 LEDs/each optic 1
 Light colour White
 Required components:

Protective plate, glass

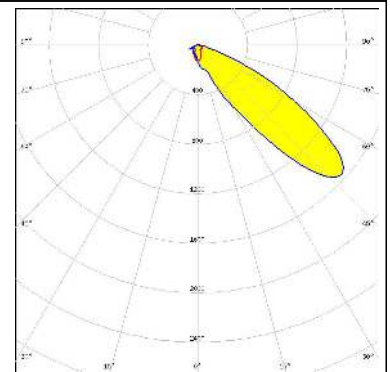

SAMSUNG

LED LH351B
 FWHM / FWTM Asymmetric
 Efficiency 81 %
 Peak intensity 1.3 cd/lm
 LEDs/each optic 1
 Light colour White
 Required components:

Protective plate, glass

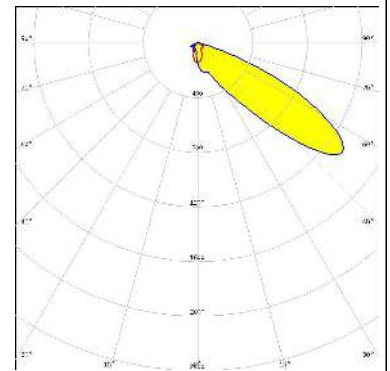

SAMSUNG

LED LH351C
 FWHM / FWTM Asymmetric
 Efficiency 94 %
 Peak intensity 1.5 cd/lm
 LEDs/each optic 1
 Light colour White
 Required components:

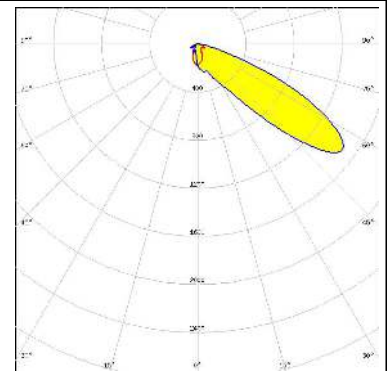

OPTICAL RESULTS (SIMULATED):

SAMSUNG

LED LH351C
 FWHM / FWTM Asymmetric
 Efficiency 83 %
 Peak intensity 1.3 cd/lm
 LEDs/each optic 1
 Light colour White
 Required components:

Protective plate, glass

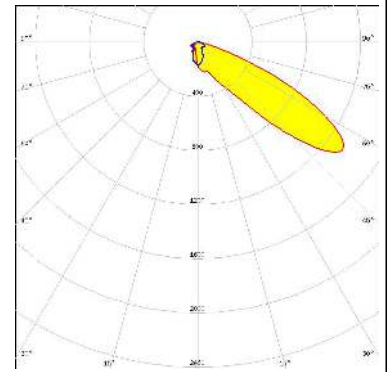

SAMSUNG

LED LH351D
 FWHM / FWTM Asymmetric
 Efficiency 88 %
 Peak intensity 1.2 cd/lm
 LEDs/each optic 1
 Light colour White
 Required components:

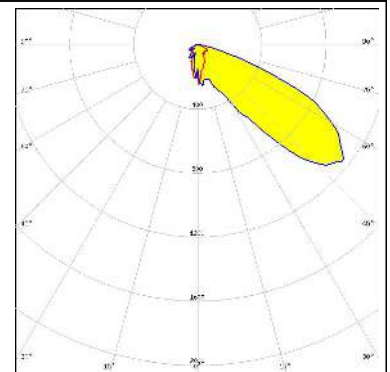

SAMSUNG

LED LM301B
 FWHM / FWTM Asymmetric
 Efficiency 95 %
 Peak intensity 1.8 cd/lm
 LEDs/each optic 1
 Light colour White
 Required components:

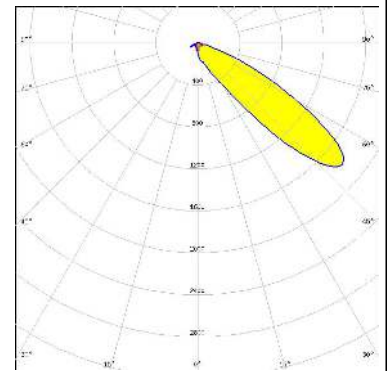

SEOUL SEMICONDUCTOR

LED Z5M1/Z5M2
 FWHM / FWTM Asymmetric
 Efficiency 94 %
 Peak intensity 1.8 cd/lm
 LEDs/each optic 1
 Light colour White
 Required components:

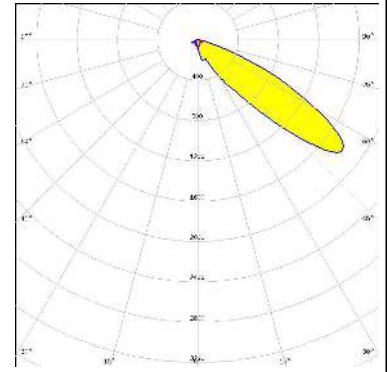

GENERAL INFORMATION:

NOTE: The typical beam angle will be changed by different color, chip size and chip position tolerance. The typical total beam angle is the full angle measured where the luminous intensity is half of the peak value.

MATERIALS:

As part of our continuous research and improvement processes, and to ensure the best possible quality and availability of our products, LEDiL reserves the right to change material grades without notice.

PRODUCT DATA USER AGREEMENT AND DISCLAIMER:

The measured data in the provided downloadable LEDiL Product Datasheets and Mechanical 2D-Drawings is rounded and provided as reference for planning. LEDiL Oy's optical specifications have been verified by conducting performance testing of the products in accordance with the company's quality system. The reported data are averaged results of multiple measurements with typical variation. LEDiL Oy reserves the right to without prior notification make changes and improvements to its products.

LEDiL Oy assumes neither warranty, nor guarantee nor any other liability of any kind for the contents and correctness of the provided data. The provided data has been generated with highest diligence but the provided data may in reality not represent the complete possible variation range of all intrinsic parameters. Therefore, in certain cases a deviation from the provided data could occur.

LEDiL Oy reserves the right to undertake technical changes of its products without further notification which could lead to changes in the provided data. LEDiL Oy assumes no liability of any kind for the possible deviation from any provided data or any other damage resulting from the usage of the provided data.

The user agrees to this disclaimer and user agreement with the download or usage of the provided files.

LEDiL Oy

Joensuunkatu 13
FI-24240 SALO
Finland

LEDiL Inc.

228 West Page Street
Suite D
Sycamore IL 60178
USA

Ledil Optics Technology (Shenzhen) Co., Ltd.

405 , Block B
Casic Motor Building
Shenzhen 518057
P.R.CHINA

Local sales and technical support

[www.ledil.com/
where_to_buy](http://www.ledil.com/where_to_buy)

Shipping locations

Salo, Finland
Hong Kong, China

Distribution Partners

[www.ledil.com/
where_to_buy](http://www.ledil.com/where_to_buy)