



CERAMIC

Low Pass Filter

LFCN-1282+

50Ω DC¹ to 12800 MHz

FEATURES

- Excellent power handling, 8W
- Small size 0.12" x .06"
- Temperature stable
- Hermetically sealed
- LTCC construction
- Protected by U.S. Patent 6,943,646



Generic photo used for illustration purposes only

CASE STYLE: FV1206-4

APPLICATIONS

- Harmonic rejection
- VHF/UHF transmitters/receivers
- Lab use

+RoHS Compliant

The +Suffix identifies RoHS Compliance. See our website for methodologies and qualifications

PRODUCT OVERVIEW

The LFCN-1282+ Low Pass Filter gives microwave communication system designers the ability to reject unwanted harmonics using defined RF parameters. The multilayer construction gives high repeatability of performance. Small wrap-around terminations minimize variations in performance due to parasitics. Covering DC-12800 MHz, these units offer low insertion loss and good rejection.

KEY FEATURES

Feature	Advantages
Small Size (3.20mm x1.6 mm)	Allows for high layout density of circuit boards, while minimizing affects of parasitics.
Rejection peaks at harmonic frequencies	Provides good rejection of signals at harmonic frequencies, for improved system performance.
Wrap around termination	Provides excellent solderability and easy visual inspection capability.
LTCC construction	Provides a rugged package that is well suited for tough environments including high humidity and high temperature extremes.

REV. B
ECO-014494
LFCN-1282+
BK/CP/AM
220808





CERAMIC

Low Pass Filter

LFCN-1282+

Mini-Circuits

50Ω DC¹ to 12800 MHz

ELECTRICAL SPECIFICATIONS^{1,2} AT 25°C

Parameter	F#	Frequency (MHz)	Min.	Typ.	Max.	Units	
Passband	Insertion Loss	DC-F1	DC-12800	—	1.2	4.0	dB
	Freq. Cut-Off	F2	13900	—	3.0	—	dB
	VSWR	DC-F1	DC-12800	—	1.7	—	:1
Stop Band	Rejection Loss	F3-F6	16200-19500	20	30	—	dB
		F4-F5	16500-20000	—	40	—	dB
	VSWR	F3-F6	16200-20330	—	40	—	:1

1. In Application where DC voltage is present at either input or output ports, coupling capacitors are required.

2. Measured on Mini-Circuits Characterization Test Board TB-810+.

MAXIMUM RATINGS

Parameter	Ratings
Operating temperature	-55°C to 100°C
Storage temperature	-55°C to 100°C
RF Power Input ³	8 W max. at 25°C

3. Passband rating, derate linearly to 3W at 100°C ambient. Permanent damage may occur if any of these limits are exceeded.

TYPICAL FREQUENCY RESPONSE

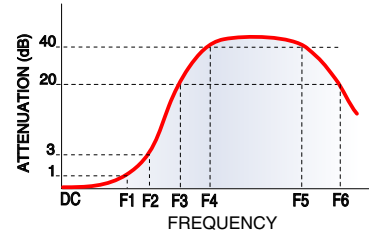

FUNCTIONAL SCHEMATIC

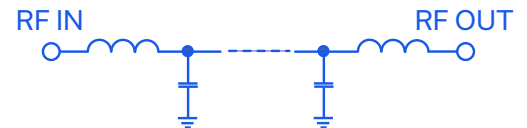



CERAMIC

Low Pass Filter

LFCN-1282+

Mini-Circuits

50Ω DC¹ to 12800 MHz

PIN CONNECTIONS

RF IN	1
RF OUT	3
GROUND	2,4

PRODUCT MARKING: EX

DEMO BOARD MCL P/N: TB-810
SUGGESTED PCB LAYOUT (PL-546)

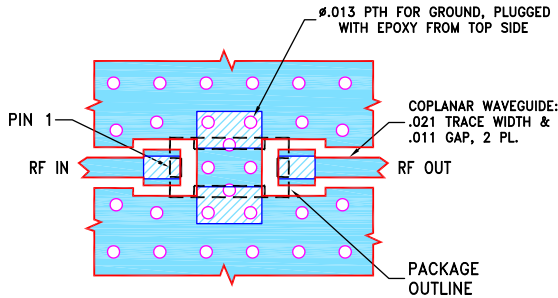

NOTES:

- TRACE WIDTH & GAP PARAMETERS ARE SHOWN FOR ROGERS R04350B WITH DIELECTRIC THICKNESS $.010 \pm .001$. COPPER: 1/2 OZ. EACH SIDE. FOR OTHER MATERIALS TRACE WIDTH & GAP MAY NEED TO BE MODIFIED.
- BOTTOM SIDE OF THE PCB IS CONTINUOUS GROUND PLANE.

- DENOTES PCB COPPER LAYOUT WITH SMOBC (SOLDER MASK OVER BARE COPPER).
- DENOTES COPPER LAND PATTERN FREE OF SOLDER MASK.

OUTLINE DRAWING

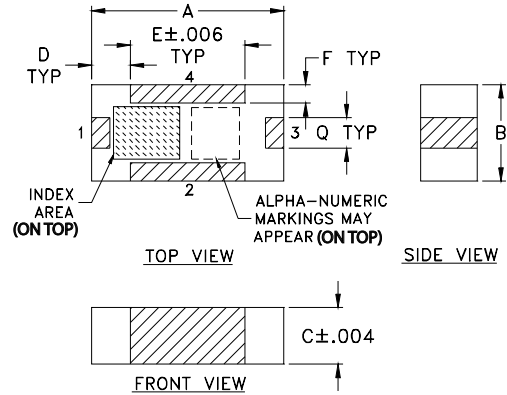

PCB Land Pattern

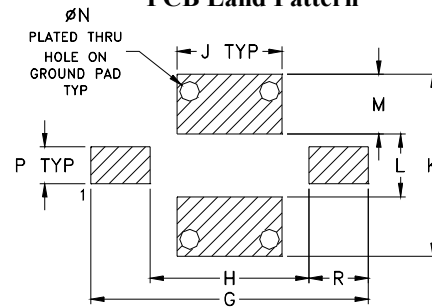

Suggested Layout,
Tolerance to be within $\pm .002$

OUTLINE DIMENSIONS (Inches mm)

A	B	C	D	E	F	G	H	J
.126	.063	.037	.026	.075	.012	.182	.104	.069
3.20	1.60	0.94	0.66	1.91	0.30	4.62	2.64	1.75
K	L	M	N	P	Q	R	wt	
.119	.041	.039	.013	.024	.020	.039	grams	
3.02	1.04	0.99	0.33	0.61	0.51	0.99	.020	

TAPE & REEL INFORMATION: F75



CERAMIC

Low Pass Filter

LFCN-1282+

Mini-Circuits

50Ω DC¹ to 12800 MHz

TYPICAL PERFORMANCE DATA AT 25°C

Frequency (MHz)	Insertion Loss (dB)	VSWR (:1)
1000	0.19	1.31
2000	0.38	1.57
5000	0.33	1.44
10000	0.50	1.29
12800	1.21	1.68
13900	3.23	3.34
15800	40.08	52.68
16000	48.40	57.61
18000	43.84	164.64
20000	39.31	206.37

LFCN-1282+
INSERTION LOSS

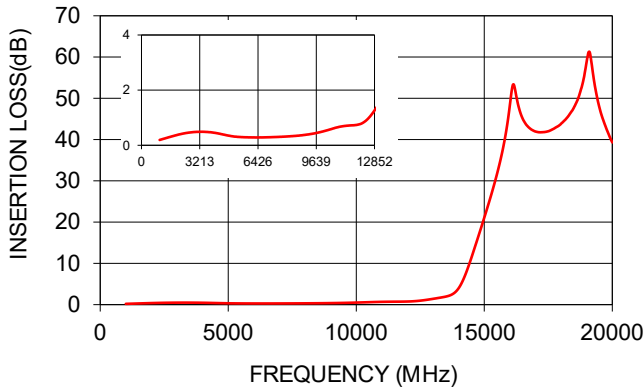

LFCN-1282+
VSWR

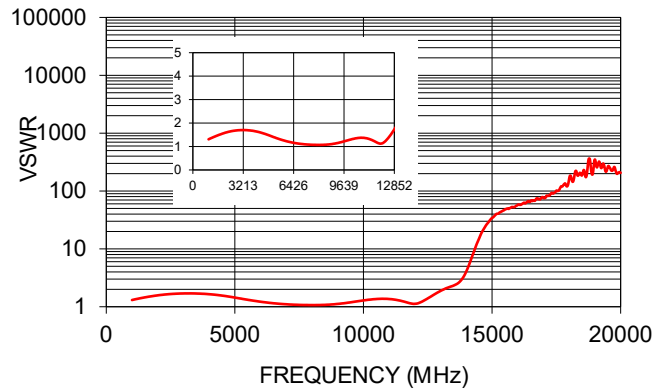

NOTES

- A. Performance and quality attributes and conditions not expressly stated in this specification document are intended to be excluded and do not form a part of this specification document.
- B. Electrical specifications and performance data contained in this specification document are based on Mini-Circuit's applicable established test performance criteria and measurement instructions.
- C. The parts covered by this specification document are subject to Mini-Circuits standard limited warranty and terms and conditions (collectively, "Standard Terms"); Purchasers of this part are entitled to the rights and benefits contained therein. For a full statement of the standard. Terms and the exclusive rights and remedies thereunder, please visit Mini-Circuits' website at www.minicircuits.com/terms/viewterm.html

