

**FineAdjust
Applicator**

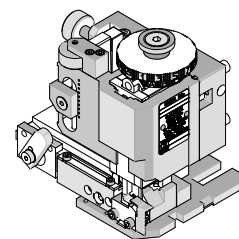

**Application Tooling
Specification Sheet**



Order No. 63904-1100

FEATURES THIS APPLICATOR IS FOR AUTOMATIC WIRE PROCESSOR USE ONLY.

- Quick punch removal with the push of a button for fast and easy tooling change
- Applicator designed to industry standard mounting and shut height 135.80mm (5.346")
- Quick set-up time; plus the crimp height, track and feed adjustments can be set without removing the applicator from the press
- Fine adjustment allows users to achieve target with little effort by adjusting in increments of .015mm (.0006") for conductor crimp height and .063mm (.0025") for insulation height
- Independent adjustment rings allow users to quickly adjust the conductor or insulation crimp height without affecting each other
- Directly adapts to most automatic wire processing machines

SCOPE

Products: SRC Connector using MX150 Blade Terminals, 2.00mm² wires.

Terminal Series No.	Terminal Order No.		Wire Size		Insulation Diameter		Strip Length	
			Wire Type	mm ²	mm	In.	mm	In.
33000	33000-1001		FLRY-B	2.00	2.40-2.80	.094-.110	4.70-5.60	.185-.220
33011	33011-0002	33011-3003	FLRY-B	2.00	2.40-2.80	.094-.110	4.70-5.60	.185-.220

Terminals were validated using the following wire specifications: ISO 6722-1, Class B

DEFINITION OF TERMS

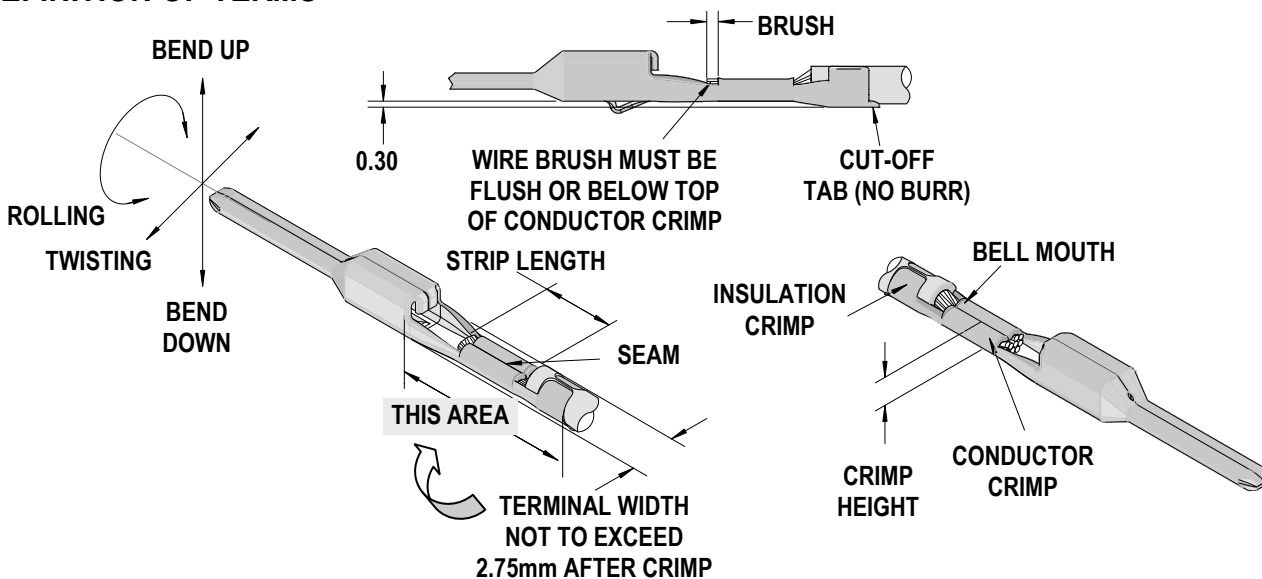

CRIMP SPECIFICATION

Terminal Series No.	Bell mouth		Cut-off Tab (Max)		◆ Conductor Brush (Max)	
	mm	In.	mm	In.	mm	In.
33000	0.30-0.70	.012-.028	0.50	.020	0.40	.016
33011	0.30-0.70	.012-.028	0.50	.020	0.40	.016

◆ Wire brush must be flush or below top of Conductor Crimp.

◆ THIS APPLICATOR IS INTENDED FOR AUTOMATIC WIRE PROCESSOR USE ONLY.

It is very important that the brush length is consistently within specification for this sealed connector system to work properly. This applicator should only be run in a properly setup automatic wire processor in order to consistently achieve the brush length. Any attempt to use this applicator outside a properly setup automatic wire processor will likely not meet the brush specification and cause this sealed connector system to not work properly.

Terminal Series No.	Bend up	Bend down	Twist Roll		Punch Width (Ref)				Conductor Seam Seam shall not be open and no wire allowed out of the crimping area
					Conductor		Insulation		
	Degree		Degree		mm	In	mm	In	
33000	3	3	3	3	2.40	.094	2.60	.102	
33011	3	3	3	3	2.40	.094	2.60	.102	

After crimping, the crimp profiles should measure the following:

Terminal Series No.	Wire Size		Conductor				Insulation				Pull Force Minimum	
			Crimp Height		Crimp Width		Crimp Height (Ref)		Crimp Width (Ref)			
	Wire Type	mm ²	mm	In.	mm	In.	mm	In.	mm	In.	N	Lb.
33000	FLRY-B	2.00	1.55-1.65	.061-.065	2.35-2.55	.093-.100	2.70	.106	2.70	.106	180	40.5
33011	FLRY-B	2.00	1.55-1.65	.061-.065	2.35-2.55	.093-.100	2.70	.106	2.70	.106	180	40.5

Tool Qualification Notes:

1. Pull Force should be measured with no influence from the insulation crimp.
2. The above specifications are guidelines to an optimum crimp.

Adjusting the Wire Brush Length

(See Item 11 in parts list and assembly drawing.)

1. If the wire brush is too long or extends above the top of the conductor crimp, adjust the Wire Stop, Item 11, closer to the conductor punch.
2. If the wire brush is too short, adjust the Wire Stop further away from the conductor punch.

PARTS LIST

FineAdjust Applicator 63904-1100				
Item	Order No	Engineering No.	Description	Quantity
Perishable Tooling				
	63904-1170	63904-1170	Tool Kit (All "Y" Items)	REF
1	63444-2437	63444-2437	Conductor Punch	1 Y
2	63445-2467	63445-2467	Conductor Anvil	1 Y
3	63454-0073	63454-0073	Insulation Punch	1 Y
4	63456-2603	63456-2603	Insulation Anvil	1 Y
5	63443-0037	63443-0037	Cut-Off Plunger	1 Y
6	63443-0038	63443-0038	Front Plunger Retainer	1 Y
Other Components				
7	11-17-0022	1739-21	Hold Down Spring	1
8	11-18-4094	60709A111	Feed Guide	1
9	63443-0009	63443-0009	Scrap Chute	1
10	63443-0024	63443-0024	Key	1
11	63443-0090	63443-0090	Wire Stop	1
12	63443-0093	63443-0093	Shank	1
13	63443-1717	63443-1717	Height Spacer (18.70mm)	1
14	63443-2205	63443-2205	Coarse Spacer (5.00mm)	1
15	63443-2212	63443-2212	Coarse Spacer (12.00mm)	1
16	63443-2804	63443-2804	Front Plunger Striker	1
17	63443-2915	63443-2915	Wire Hold Down Plunger	1
18	63443-6122	63443-6122	Rear Cover	1
19	63443-7102	63443-7102	Terminal Hold Down	1
20	63600-1057	63600-1057	Striker Plunger Spring	1
21	63700-0539	63700-0539	Cut-off Plunger Spring	1
Frame				
22	63800-4901	63800-4901	Top	1
23	63801-3281	63801-3281	Base	1
24	63801-4650	63801-4650	Track	1
24A	63459-0001	63459-0001	Terminal Track	1
Hardware				
25	N/A	N/A	M3 by 6 Long SHCS	2**
26	N/A	N/A	M3 by 6 Long FHCS	1**
27	N/A	N/A	M3 by 8 Long SHCS	1**
28	N/A	N/A	M4 by 6 Long SHCS	2**
29	N/A	N/A	M4 by 12 Long BHCS	2**
30	N/A	N/A	M4 by 50 Long SHCS	2**
31	N/A	N/A	M5 by 12 Long SHCS	1**
32	N/A	N/A	#10-32 by 3/8" Long Flat Point SSS	1**
33	N/A	N/A	#10-32 Hex Jam Nut	1**

** Available from an industrial supply company such as MSC (1-800-645-7270).

Assembly Drawing

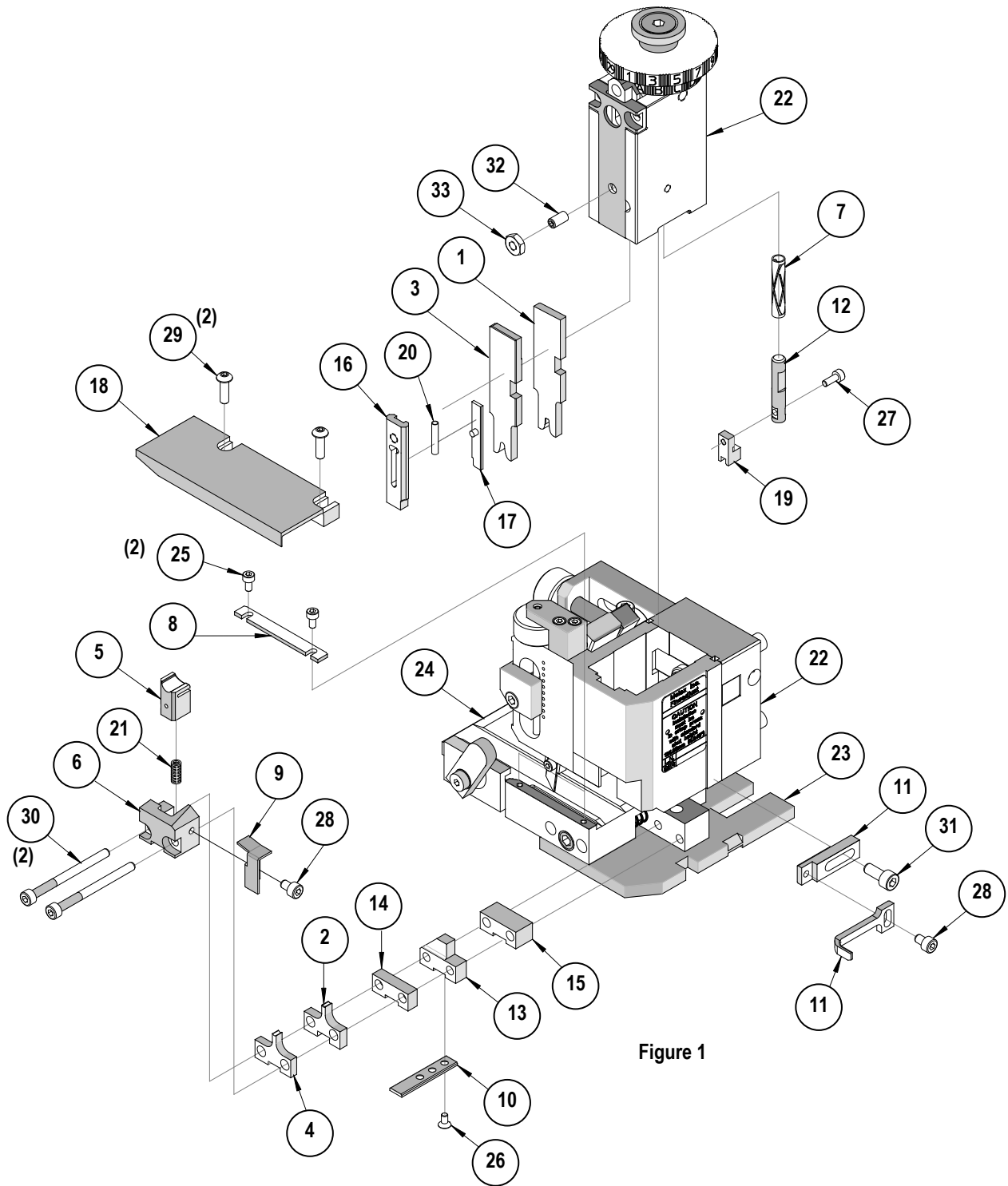

Figure 1

NOTES

1. Molex recommends an extra perishable tooling kit be maintained at your facility.
2. Verify tooling alignment by manually cycling the press and Applicator before crimping under power. Check that all screws are tight.
3. Slugs, Terminals, Dirt and Oil should be kept clear of work area.
4. Wear safety glasses at all times.
5. For recommended maintenance refer to the FineAdjust Manual.

Insulation Attribute Notes:

In order to help ensure the integrity of the connector seal, the design intent is to partially bury the insulation grips into the wire insulation. Due to this, skiving of the insulation may occur. This skiving attribute is acceptable.

Below are examples of insulation skiving that may be seen with this connector system.

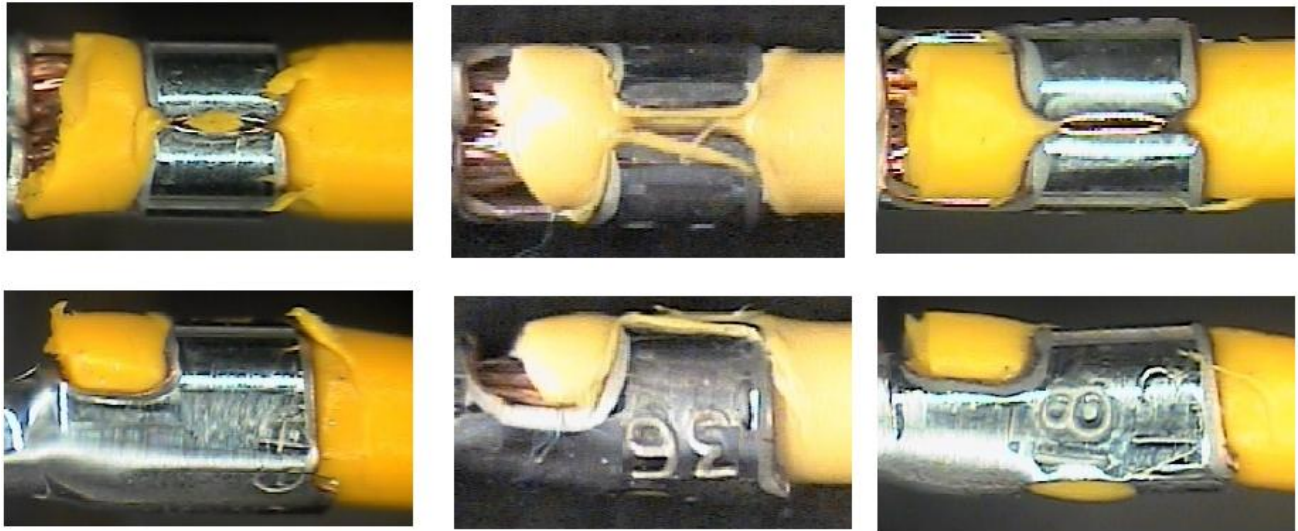

CAUTION: This applicator should only be used in a press with a shut height of 135.80 mm (5.346"). Tooling damage could result at a lower setting.

CAUTION: To prevent injury never operate this Applicator without the guards supplied with the press or wire-processing machine in place. Reference the press or wire processing manufacturer's instruction manual.

CAUTION: These Molex crimp specifications are valid only when used with Molex terminals, applicators and tooling qualified by Molex. When using non-Molex tooling with this specific connector system listed in this document, the Molex qualification does not apply and the responsibility for full qualification of the connector system is that of the customer. Molex accepts no liability for tooling support where non-Molex tooling is used.

Visit our Web site at <http://www.molex.com>