

MC14013B

Dual Type D Flip-Flop

The MC14013B dual type D flip-flop is constructed with MOS P-channel and N-channel enhancement mode devices in a single monolithic structure. Each flip-flop has independent Data, (D), Direct Set, (S), Direct Reset, (R), and Clock (C) inputs and complementary outputs (Q and \bar{Q}). These devices may be used as shift register elements or as type T flip-flops for counter and toggle applications.

- Static Operation
- Diode Protection on All Inputs
- Supply Voltage Range = 3.0 Vdc to 18 Vdc
- Logic Edge-Clocked Flip-Flop Design
Logic state is retained indefinitely with clock level either high or low; information is transferred to the output only on the positive-going edge of the clock pulse
- Capable of Driving Two Low-power TTL Loads or One Low-power Schottky TTL Load Over the Rated Temperature Range
- Pin-for-Pin Replacement for CD4013B

MAXIMUM RATINGS (Voltages Referenced to V_{SS}) (Note 2.)

Symbol	Parameter	Value	Unit
V_{DD}	DC Supply Voltage Range	-0.5 to +18.0	V
V_{in}, V_{out}	Input or Output Voltage Range (DC or Transient)	-0.5 to $V_{DD} + 0.5$	V
I_{in}, I_{out}	Input or Output Current (DC or Transient) per Pin	± 10	mA
P_D	Power Dissipation, per Package (Note 3.)	500	mW
T_A	Ambient Temperature Range	-55 to +125	$^{\circ}\text{C}$
T_{stg}	Storage Temperature Range	-65 to +150	$^{\circ}\text{C}$
T_L	Lead Temperature (8-Second Soldering)	260	$^{\circ}\text{C}$

2. Maximum Ratings are those values beyond which damage to the device may occur.

3. Temperature Derating:
Plastic "P and D/DW" Packages: - 7.0 mW/ $^{\circ}\text{C}$ From 65 $^{\circ}\text{C}$ To 125 $^{\circ}\text{C}$

This device contains protection circuitry to guard against damage due to high static voltages or electric fields. However, precautions must be taken to avoid applications of any voltage higher than maximum rated voltages to this high-impedance circuit. For proper operation, V_{in} and V_{out} should be constrained to the range $V_{SS} \leq (V_{in} \text{ or } V_{out}) \leq V_{DD}$.

Unused inputs must always be tied to an appropriate logic voltage level (e.g., either V_{SS} or V_{DD}). Unused outputs must be left open.



ON Semiconductor

<http://onsemi.com>

MARKING DIAGRAMS

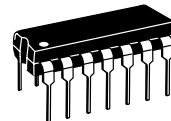

PDIP-14
P SUFFIX
CASE 646

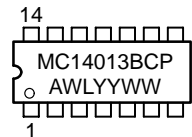

SOIC-14
D SUFFIX
CASE 751A

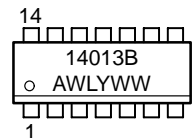

TSSOP-14
DT SUFFIX
CASE 948G

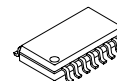
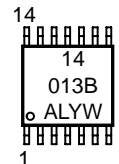

SOEIAJ-14
F SUFFIX
CASE 965

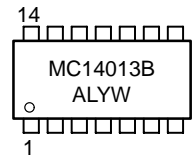

A = Assembly Location
WL, L = Wafer Lot
YY, Y = Year
WW, W = Work Week



ORDERING INFORMATION

Device	Package	Shipping
MC14013BCP	PDIP-14	2000/Box
MC14013BD	SOIC-14	55/Rail
MC14013BDR2	SOIC-14	2500/Tape & Reel
MC14013BDT	TSSOP-14	96/Rail
MC14013BDTR2	TSSOP-14	2500/Tape & Reel
MC14013BF	SOEIAJ-14	See Note 1.
MC14013BFEL	SOEIAJ-14	See Note 1.

1. For ordering information on the EIAJ version of the SOIC packages, please contact your local ON Semiconductor representative.

MC14013B

TRUTH TABLE

Inputs				Outputs	
Clock†	Data	Reset	Set	Q	\bar{Q}
	0	0	0	0	1
	1	0	0	1	0
	X	0	0	Q	\bar{Q}
X	X	1	0	0	1
X	X	0	1	1	0
X	X	1	1	1	1

No
Change

X = Don't Care
† = Level Change

PIN ASSIGNMENT

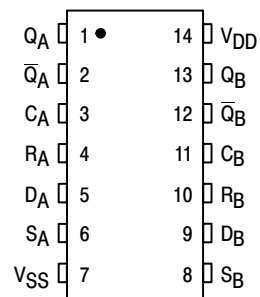

BLOCK DIAGRAM

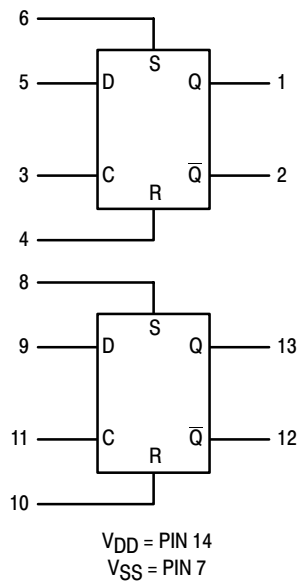

MC14013B

ELECTRICAL CHARACTERISTICS (Voltages Referenced to V_{SS})

Characteristic	Symbol	V _{DD} Vdc	- 55°C		25°C			125°C		Unit	
			Min	Max	Min	Typ (4.)	Max	Min	Max		
Output Voltage V _{in} = V _{DD} or 0 V _{in} = 0 or V _{DD}	“0” Level V _{OL}	5.0	—	0.05	—	0	0.05	—	0.05	Vdc	
		10	—	0.05	—	0	0.05	—	0.05		
		15	—	0.05	—	0	0.05	—	0.05		
	“1” Level V _{OH}	5.0	4.95	—	4.95	5.0	—	4.95	—		Vdc
		10	9.95	—	9.95	10	—	9.95	—		
		15	14.95	—	14.95	15	—	14.95	—		
Input Voltage “0” Level (V _O = 4.5 or 0.5 Vdc) (V _O = 9.0 or 1.0 Vdc) (V _O = 13.5 or 1.5 Vdc) “1” Level (V _O = 0.5 or 4.5 Vdc) (V _O = 1.0 or 9.0 Vdc) (V _O = 1.5 or 13.5 Vdc)	V _{IL}	5.0	—	1.5	—	2.25	1.5	—	1.5	Vdc	
		10	—	3.0	—	4.50	3.0	—	3.0		
		15	—	4.0	—	6.75	4.0	—	4.0		
	V _{IH}	5.0	3.5	—	3.5	2.75	—	3.5	—		Vdc
		10	7.0	—	7.0	5.50	—	7.0	—		
		15	11	—	11	8.25	—	11	—		
Output Drive Current (V _{OH} = 2.5 Vdc) (V _{OH} = 4.6 Vdc) (V _{OH} = 9.5 Vdc) (V _{OH} = 13.5 Vdc) (V _{OL} = 0.4 Vdc) (V _{OL} = 0.5 Vdc) (V _{OL} = 1.5 Vdc)	Source I _{OH}	5.0	- 3.0	—	- 2.4	- 4.2	—	- 1.7	—	mAdc	
		5.0	- 0.64	—	- 0.51	- 0.88	—	- 0.36	—		
		10	- 1.6	—	- 1.3	- 2.25	—	- 0.9	—		
		15	- 4.2	—	- 3.4	- 8.8	—	- 2.4	—		
	Sink I _{OL}	5.0	0.64	—	0.51	0.88	—	0.36	—		mAdc
		10	1.6	—	1.3	2.25	—	0.9	—		
15	4.2	—	3.4	8.8	—	2.4	—	—			
Input Current	I _{in}	15	—	± 0.1	—	± 0.00001	± 0.1	—	± 1.0	µAdc	
Input Capacitance (V _{in} = 0)	C _{in}	—	—	—	—	5.0	7.5	—	—	pF	
Quiescent Current (Per Package)	I _{DD}	5.0	—	1.0	—	0.002	1.0	—	30	µAdc	
		10	—	2.0	—	0.004	2.0	—	60		
		15	—	4.0	—	0.006	4.0	—	120		
Total Supply Current (5.) (6.) (Dynamic plus Quiescent, Per Package) (C _L = 50 pF on all outputs, all buffers switching)	I _T	5.0 10 15	$I_T = (0.75 \mu\text{A/kHz}) f + I_{DD}$ $I_T = (1.5 \mu\text{A/kHz}) f + I_{DD}$ $I_T = (2.3 \mu\text{A/kHz}) f + I_{DD}$							µAdc	

4. Data labelled “Typ” is not to be used for design purposes but is intended as an indication of the IC’s potential performance.

5. The formulas given are for the typical characteristics only at 25°C.

6. To calculate total supply current at loads other than 50 pF:

$$I_T(C_L) = I_T(50 \text{ pF}) + (C_L - 50) Vfk$$

where: I_T is in µA (per package), C_L in pF, V = (V_{DD} - V_{SS}) in volts, f in kHz is input frequency, and k = 0.002.

MC14013B

SWITCHING CHARACTERISTICS (7.) ($C_L = 50 \text{ pF}$, $T_A = 25^\circ\text{C}$)

Characteristic	Symbol	V _{DD}	Min	Typ (8.)	Max	Unit
Output Rise and Fall Time t_{TLH} , $t_{THL} = (1.5 \text{ ns/pF}) C_L + 25 \text{ ns}$ t_{TLH} , $t_{THL} = (0.75 \text{ ns/pF}) C_L + 12.5 \text{ ns}$ t_{TLH} , $t_{THL} = (0.55 \text{ ns/pF}) C_L + 9.5 \text{ ns}$	t_{TLH} , t_{THL}	5.0 10 15	— — —	100 50 40	200 100 80	ns
Propagation Delay Time Clock to Q, \bar{Q} t_{PLH} , $t_{PHL} = (1.7 \text{ ns/pF}) C_L + 90 \text{ ns}$ t_{PLH} , $t_{PHL} = (0.66 \text{ ns/pF}) C_L + 42 \text{ ns}$ t_{PLH} , $t_{PHL} = (0.5 \text{ ns/pF}) C_L + 25 \text{ ns}$ Set to Q, \bar{Q} t_{PLH} , $t_{PHL} = (1.7 \text{ ns/pF}) C_L + 90 \text{ ns}$ t_{PLH} , $t_{PHL} = (0.66 \text{ ns/pF}) C_L + 42 \text{ ns}$ t_{PLH} , $t_{PHL} = (0.5 \text{ ns/pF}) C_L + 25 \text{ ns}$ Reset to Q, \bar{Q} t_{PLH} , $t_{PHL} = (1.7 \text{ ns/pF}) C_L + 265 \text{ ns}$ t_{PLH} , $t_{PHL} = (0.66 \text{ ns/pF}) C_L + 67 \text{ ns}$ t_{PLH} , $t_{PHL} = (0.5 \text{ ns/pF}) C_L + 50 \text{ ns}$	t_{PLH} t_{PHL}	5.0 10 15 5.0 10 15 5.0 10 15	— — — — — — — — —	175 75 50 175 75 50 225 100 75	350 150 100 350 150 100 450 200 150	ns
Setup Times (9.)	t_{su}	5.0 10 15	40 20 15	20 10 7.5	— — —	ns
Hold Times (9.)	t_h	5.0 10 15	40 20 15	20 10 7.5	— — —	ns
Clock Pulse Width	t_{WL} , t_{WH}	5.0 10 15	250 100 70	125 50 35	— — —	ns
Clock Pulse Frequency	f_{cl}	5.0 10 15	— — —	4.0 10 14	2.0 5.0 7.0	MHz
Clock Pulse Rise and Fall Time	t_{TLH} t_{THL}	5.0 10 15	— — —	— — —	15 5.0 4.0	μs
Set and Reset Pulse Width	t_{WL} , t_{WH}	5.0 10 15	250 100 70	125 50 35	— — —	ns
Removal Times Set Reset	t_{rem}	5 10 15 5 10 15	80 45 35 50 30 25	0 5 5 -35 -10 -5	— — — — — —	ns

7. The formulas given are for the typical characteristics only at 25°C.

8. Data labelled "Typ" is not to be used for design purposes but is intended as an indication of the IC's potential performance.

9. Data must be valid for 250 ns with a 5 V supply, 100 ns with 10 V, and 70 ns with 15 V.

MC14013B

LOGIC DIAGRAM (1/2 of Device Shown)

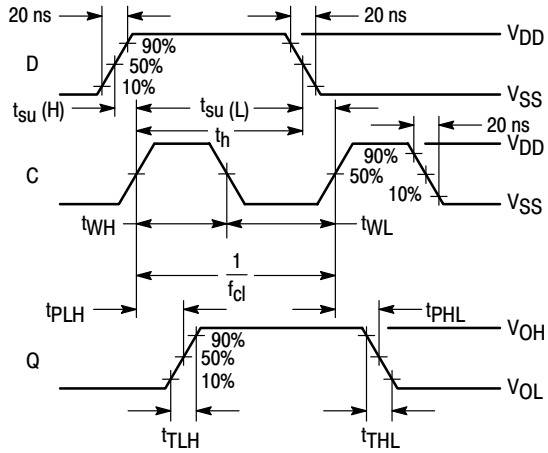
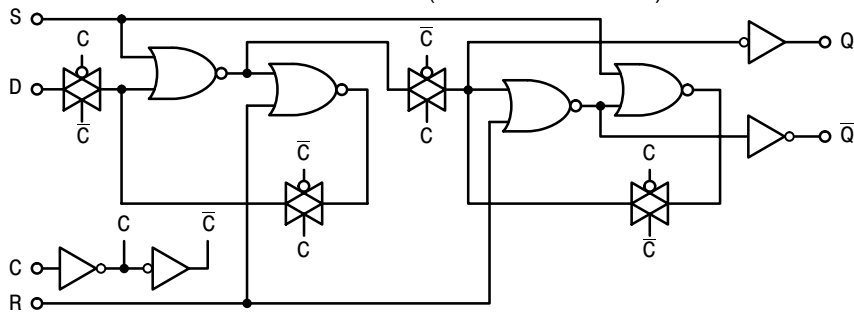

Inputs R and S low.

Figure 1. Dynamic Signal Waveforms (Data, Clock, and Output)

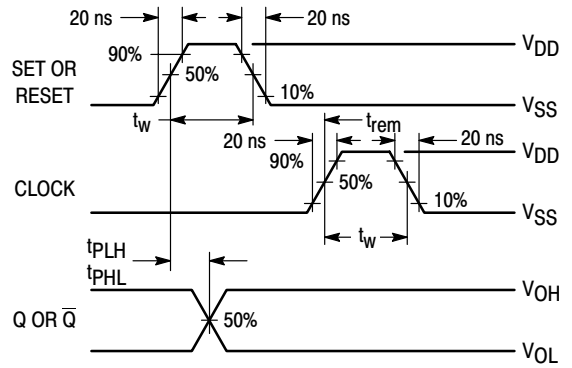
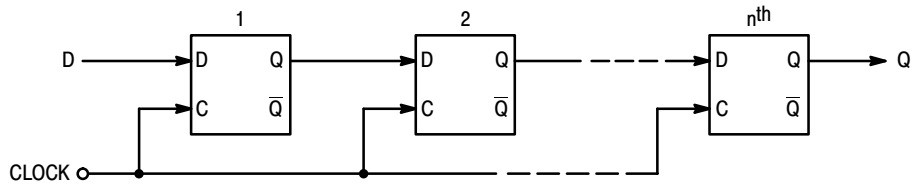

Figure 2. Dynamic Signal Waveforms (Set, Reset, Clock, and Output)

MC14013B

TYPICAL APPLICATIONS

n-STAGE SHIFT REGISTER



BINARY RIPPLE UP-COUNTER (Divide-by- 2^n)

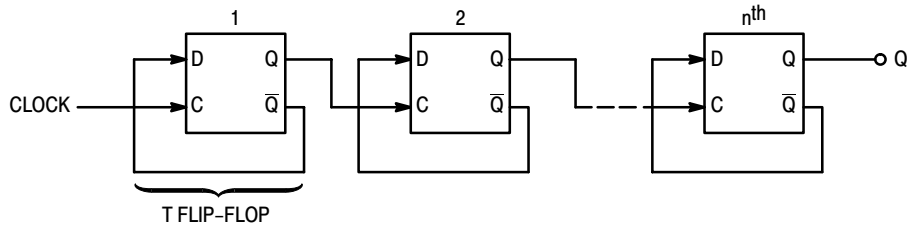

MODIFIED RING COUNTER (Divide-by- $(n+1)$)

