

Double-Balanced Mixer

5 - 20 GHz



MAMX-011067

Rev. V1

Features

- Low Conversion Loss: 6 dB
- Wide IF Bandwidth: DC to 6 GHz
- IIP3 +21 dBm @ 15 dBm LO Drive
- High Isolation
- Lead-Free 3 mm 12-lead QFN Package
- RoHS* Compliant

Applications

- Test & Measurement
- Microwave Radio
- Radar

Description

MAMX-011067 is a GaAs double-balanced passive diode mixer housed in a lead-free 3 mm, 12-lead QFN package. The mixer offers low conversion loss, high linearity and a wide IF bandwidth. The double-balanced circuit configuration provides excellent port isolation while internal 50 Ω matching simplifies its application.

This mixer is well suited for applications such as test and measurement, microwave radio and radar.

Ordering Information^{1,2}

Part Number	Package
MAMX-011067	Bulk
MAMX-011067-TR0500	500 Piece Reel ¹
MAMX-011067-SB1	Sample Board ²

1. Reference Application Note M513 for reel size information.
2. All sample boards include 5 loose parts.

Functional Schematic

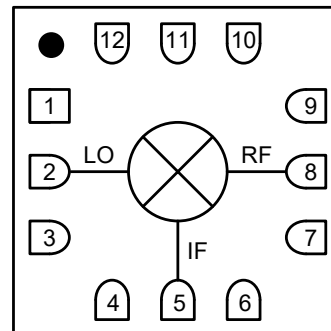

Pin Configuration

Pin #	Function
1,3,4,6,7,9	GND
2	LO
5	IF
8	RF
10 - 12	NC ³
13	GND ⁴

3. MACOM recommends connecting unused package pins to ground.
4. The exposed pad centered on the package bottom must be connected to RF, DC and thermal ground.

¹ * Restrictions on Hazardous Substances, compliant to current RoHS EU directive.

Double-Balanced Mixer

5 - 20 GHz



MAMX-011067

Rev. V1

Electrical Specifications⁵: $F_{IF} = 100 \text{ MHz}$, $P_{LO} = 15 \text{ dBm}$, $T_A = +25^\circ\text{C}$, $Z_0 = 50 \Omega$

Parameter	Test Conditions	Units	Min.	Typ.	Max.
LO and RF Frequency	—	GHz	5	—	20
IF Frequency	—	GHz	0	—	6
LO Power	—	dBm	—	15	—
Conversion Loss	5 - 20 GHz	dB	—	7	9
Input P1dB	5 - 10 GHz 10 - 20 GHz	dBm	—	8 11	—
Input IP3	$P_{RF} = -10 \text{ dBm/tone}$, $\Delta f = 1 \text{ MHz}$ 5 - 10 GHz 10 - 20 GHz	dBm	—	18 20	—
Input IP2	$P_{RF} = -10 \text{ dBm/tone}$, $\Delta f = 1 \text{ MHz}$ 5 - 10 GHz 10 - 20 GHz	dBm	—	45 45	—
LO-to-RF Isolation	5 - 10 GHz 10 - 20 GHz	dB	—	34 30	—
LO-to-IF Isolation	5 - 10 GHz 10 - 20 GHz	dB	25 28	35 40	—
RF-to-IF Isolation	5 - 10 GHz 10 - 20 GHz	dB	—	16 31	—

5. All specifications refer to down-conversion operation, unless otherwise noted.

Absolute Maximum Ratings^{6,7}

Parameter	Absolute Maximum
LO Power	23 dBm
RF or IF Power	20 dBm
Junction Temperature ⁸	+150°C
Operating Temperature	-55°C to +85°C
Storage Temperature	-65°C to +150°C

6. Exceeding any one or combination of these limits may cause permanent damage to this device.
7. MACOM does not recommend sustained operation near these survivability limits.
8. Operating at nominal conditions with $T_J \leq +150^\circ\text{C}$ will ensure $\text{MTTF} > 1 \times 10^6$ hours. Thermal resistance, Θ_{JC} is +85°C/W.

Handling Procedures

Please observe the following precautions to avoid damage:

Static Sensitivity

These electronic devices are sensitive to electrostatic discharge (ESD) and can be damaged by static electricity. Proper ESD control techniques should be used when handling these devices with the following rating:

HBM Class 1B
CDM Class C3

Double-Balanced Mixer

5 - 20 GHz



MAMX-011067

Rev. V1

MxN Spurious Rejection at IF Port (dBc IF)

RF = 10.1 GHz @ -10 dBm

LO = 10.0 GHz @ +15 dBm

mxRF	nxLO				
	0	1	2	3	4
0	x	10	32	23	36
1	20	0	43	55	60
2	94	66	64	76	90
3	91	104	110	81	88
4	x	x	x	x	110

PCB Layout

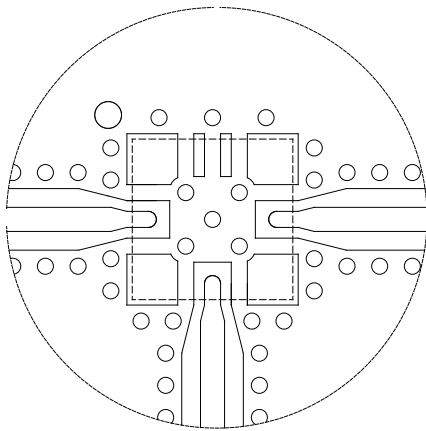

DXF available on request based on 10 mil RO4350 substrate.

Application Schematic

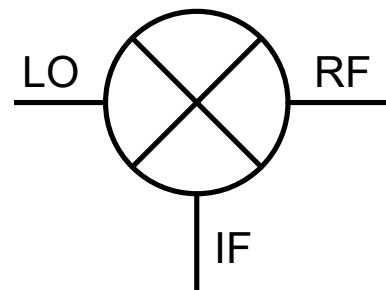

No external parts required for operation of MAMX-011067.

Double-Balanced Mixer

5 - 20 GHz



MAMX-011067

Rev. V1

Typical Performance Curves

Conversion Loss USB (Down Conversion)
@ +25°C, $I_F = 100$ MHz

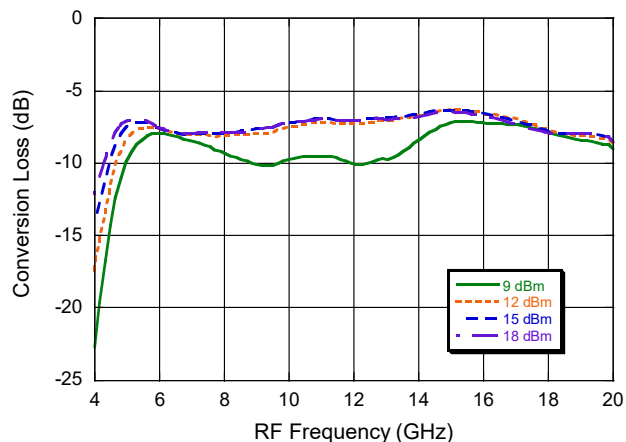

Conversion Loss USB (Up Conversion)
@ +25°C, $I_F = 100$ MHz

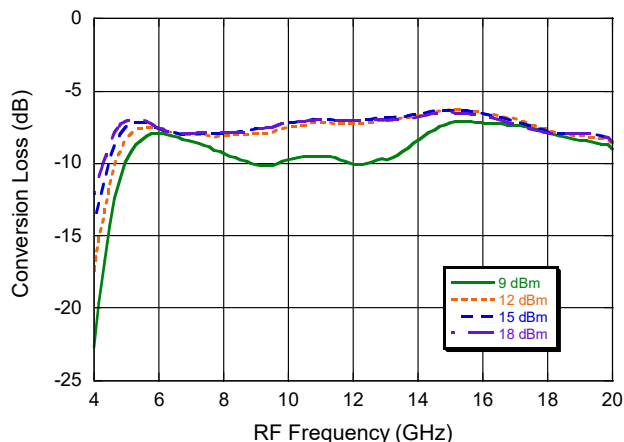

Conversion Loss Over Temperature, $I_F = 100$ MHz

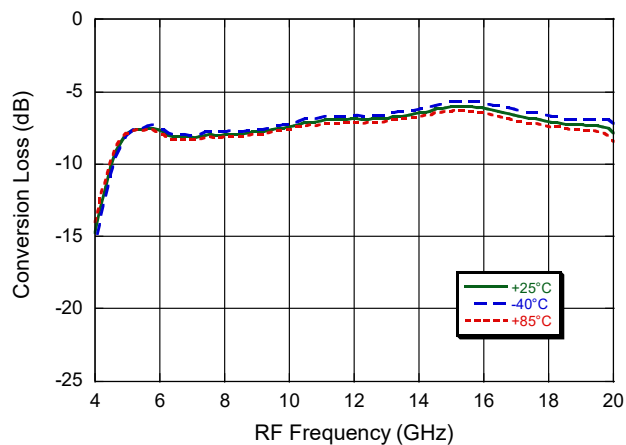

IF Bandwidth
@ +25°C, $F_{LO} = 10$ GHz, $P_{LO} = 15$ dBm

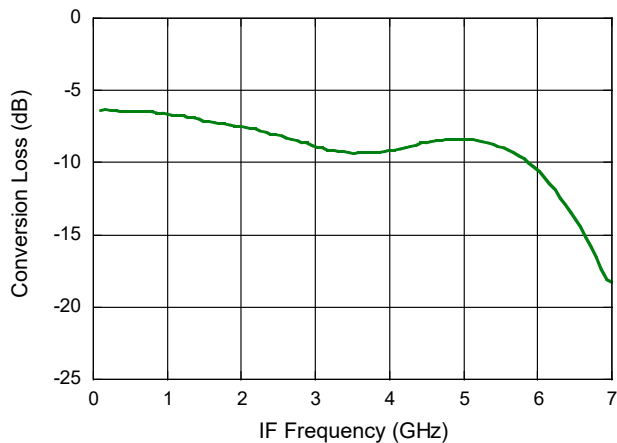

Double-Balanced Mixer

5 - 20 GHz



MAMX-011067

Rev. V1

Typical Performance Curves

IIP3 @ LO Power, $I_F = 100$ MHz

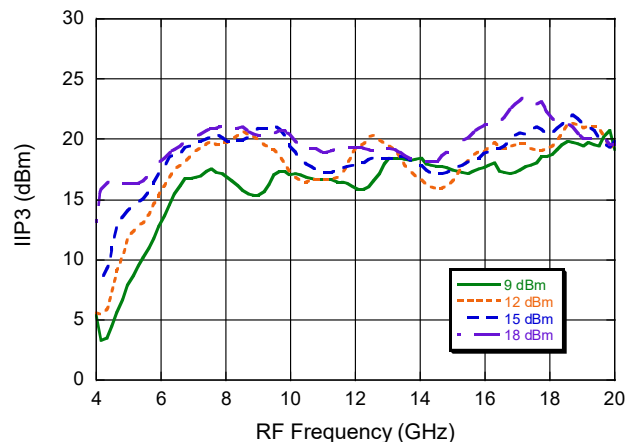

IIP3 over Temperature @ $P_{LO} = 15$ dBm, $I_F = 100$ MHz

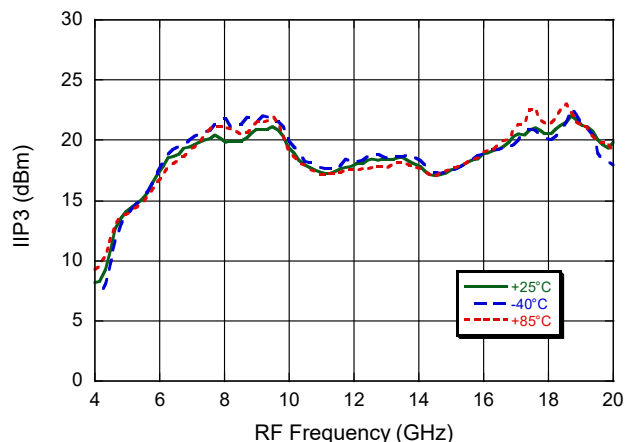

IIP2 @ LO Power, $I_F = 100$ MHz

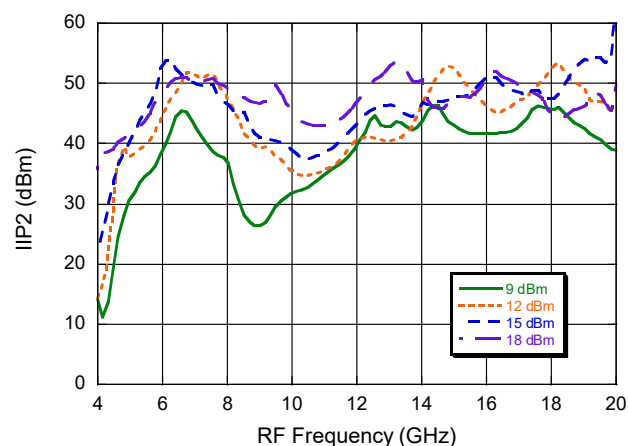

IIP2 over Temperature @ $P_{LO} = 15$ dBm, $I_F = 100$ MHz

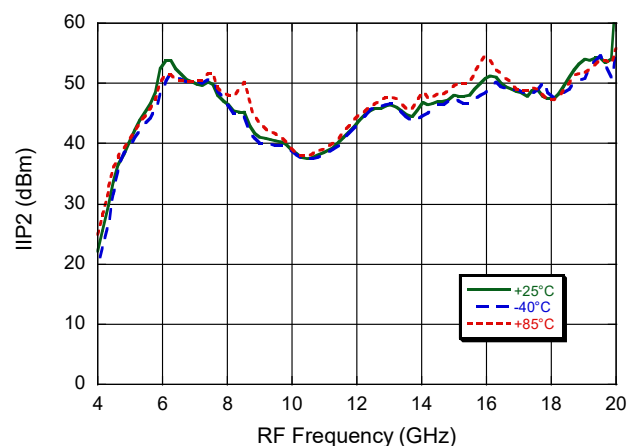

P1dB @ LO Power, $I_F = 100$ MHz

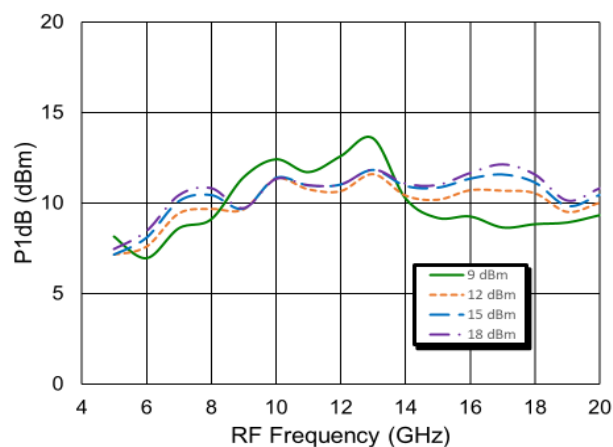

Double-Balanced Mixer

5 - 20 GHz



MAMX-011067

Rev. V1

Typical Performance Curves

Isolation (Down Conversion)

@ IF = 100 MHz, $P_{LO} = 15$ dBm; $P_{RF} = -10$ dBm

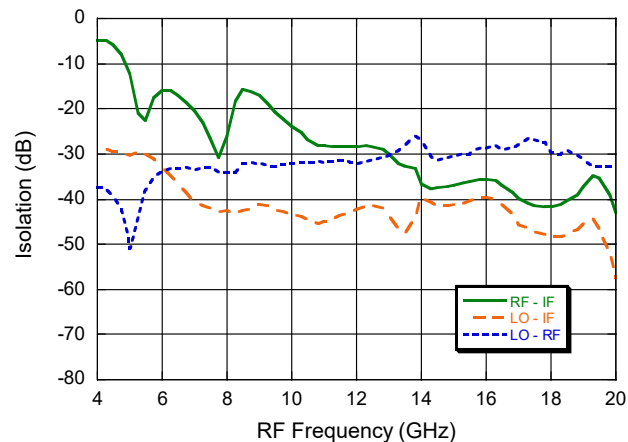

Isolation (Up Conversion)

@ IF = 100 MHz, $P_{LO} = 15$ dBm; $P_{RF} = -10$ dBm

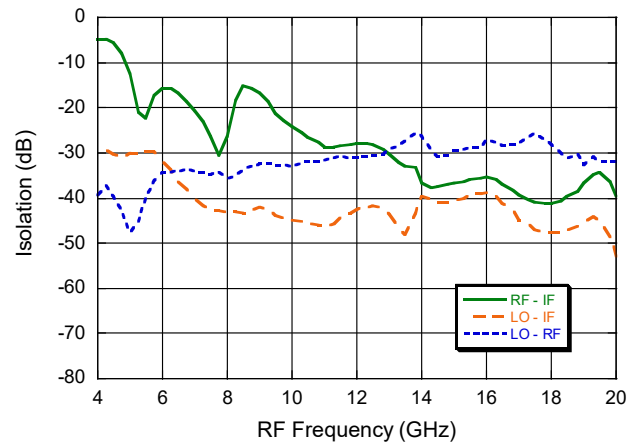

RF Return Loss

@ +25°C, $F_{LO} = 10$ GHz, $P_{LO} = 15$ dBm

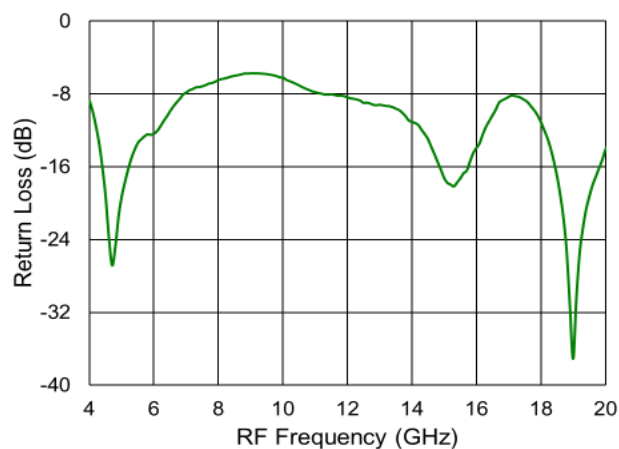

IF Return Loss

@ +25°C, $F_{LO} = 10$ GHz, $P_{LO} = 15$ dBm

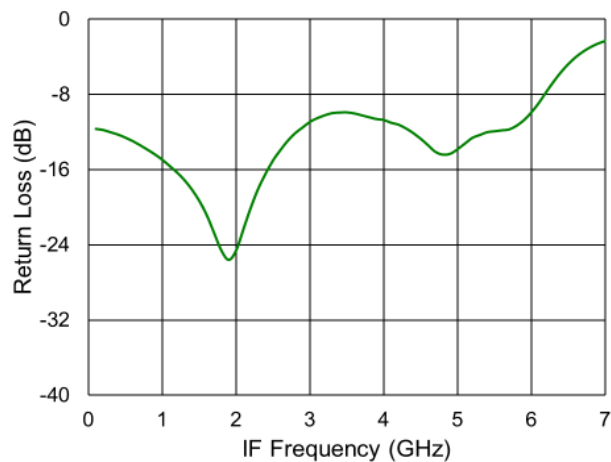

Double-Balanced Mixer

5 - 20 GHz



MAMX-011067

Rev. V1

Lead-Free 3 mm 12-Lead QFN[†]

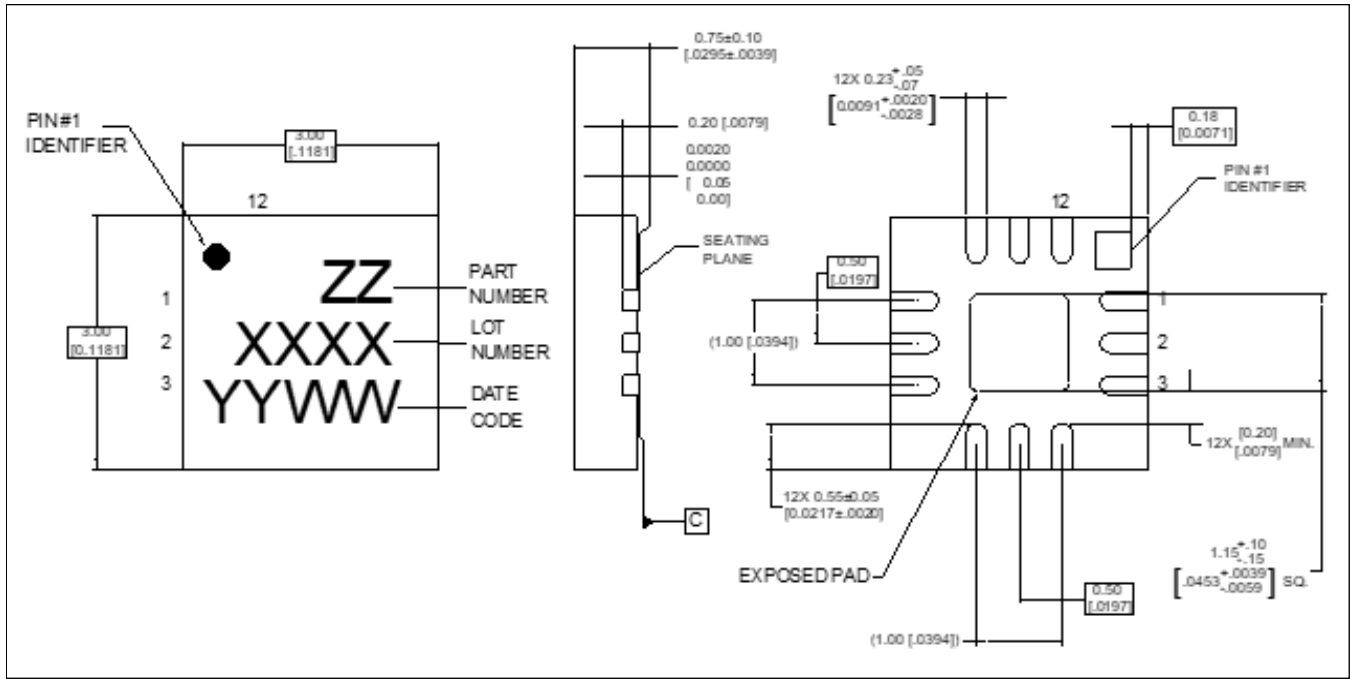

[†] Reference Application Note S2083 for lead-free solder reflow recommendations.
 Meets JEDEC moisture sensitivity level 1 requirements.
 Plating is 100% matte tin over copper.

Double-Balanced Mixer

5 - 20 GHz



MAMX-011067

Rev. V1

MACOM Technology Solutions Inc. ("MACOM"). All rights reserved.

These materials are provided in connection with MACOM's products as a service to its customers and may be used for informational purposes only. Except as provided in its Terms and Conditions of Sale or any separate agreement, MACOM assumes no liability or responsibility whatsoever, including for (i) errors or omissions in these materials; (ii) failure to update these materials; or (iii) conflicts or incompatibilities arising from future changes to specifications and product descriptions, which MACOM may make at any time, without notice. These materials grant no license, express or implied, to any intellectual property rights.

THESE MATERIALS ARE PROVIDED "AS IS" WITH NO WARRANTY OR LIABILITY, EXPRESS OR IMPLIED, RELATING TO SALE AND/OR USE OF MACOM PRODUCTS INCLUDING FITNESS FOR A PARTICULAR PURPOSE, MERCHANTABILITY, INFRINGEMENT OF INTELLECTUAL PROPERTY RIGHT, ACCURACY OR COMPLETENESS, OR SPECIAL, INDIRECT, INCIDENTAL, OR CONSEQUENTIAL DAMAGES WHICH MAY RESULT FROM USE OF THESE MATERIALS.

MACOM products are not intended for use in medical, lifesaving or life sustaining applications. MACOM customers using or selling MACOM products for use in such applications do so at their own risk and agree to fully indemnify MACOM for any damages resulting from such improper use or sale.