

### Features

- Surface Mount Package
- 1:1 Impedance Ratio
- Centre Tap on Secondary
- 75  $\Omega$  Single Ended to 75  $\Omega$  Balanced
- Suitable for DOCSIS 3.0
- RoHS Compliant
- 260°C Reflow Compatible
- Available on Tape & Reel

### Description

The MABA-011026 is a 1:1 flux coupled transformer in a surface mount package.

Ideally suited for CATV Broadband applications.

### Functional Schematic

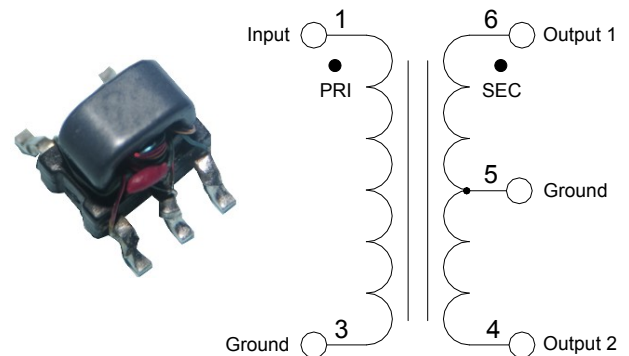

### Pin Configuration

Pin #	Function
1	Primary Dot
3	Primary
4	Secondary
5	Secondary Centre Tap
6	Secondary Dot

### Electrical Specifications: Freq. 5 - 200 MHz, $T_A = +25^\circ\text{C}$ , $Z_0 = 75 \Omega$ , $P_{IN} = 0 \text{ dBm}$

Parameter	Frequency Test Conditions (MHz)	Units	Min.	Typ.	Max.
Impedance Ratio	—	Ratio	—	1:1	—
Insertion Loss (Pin 1 - Pin 6)	5 - 60	dB	—	0.36	0.5
	60 - 150			0.50	0.7
	150 - 200			0.67	1.0
Amplitude Balance	5 - 60	dB	—	0.01	$\pm 0.1$
	60 - 200			0.09	$\pm 0.5$
Phase Balance	5 - 60	°	—	0.1	$\pm 1.0$
	60 - 200			0.5	$\pm 3.0$
Input Return Loss (Pin 1)	5 - 60	dB	20	29	—
	60 - 200		12	19	

### Ordering Information

Part Number	Package
MABA-011026	2000 piece reel
MABA-011026-TB	Customer Test Board

### Recommended Maximum Ratings

Parameter	Value
Input RF Power (28 dBm)	631 mW
DC Current (@ 5 V)	600 mA
Operating Temperature	-40°C to +100°C

## Typical Performance Curves

**Insertion Loss 1: (Pin 1 to 6)**

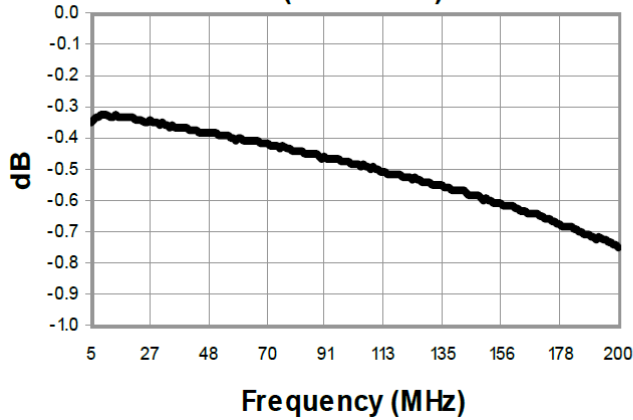

**Insertion Loss 2: (Pin 1 to 4)**

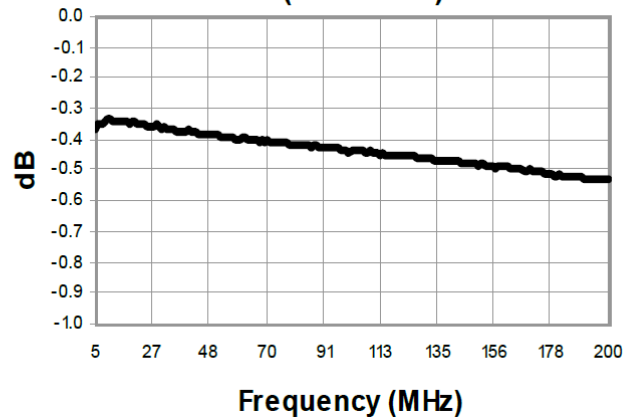

**Amplitude Balance**

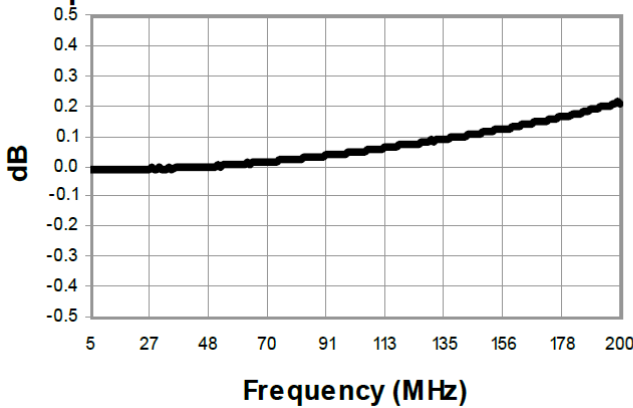

**Phase Balance**

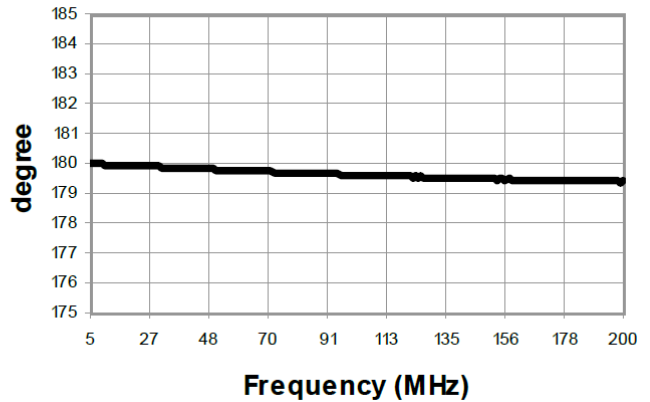

**Return Loss: Input (Pin1)**

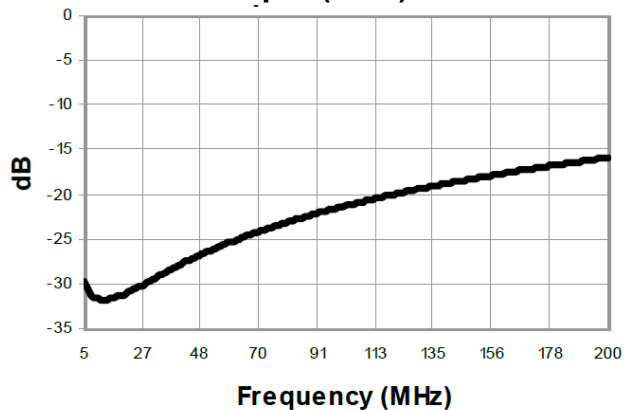

Full temperature plots available on request

## Application Circuit

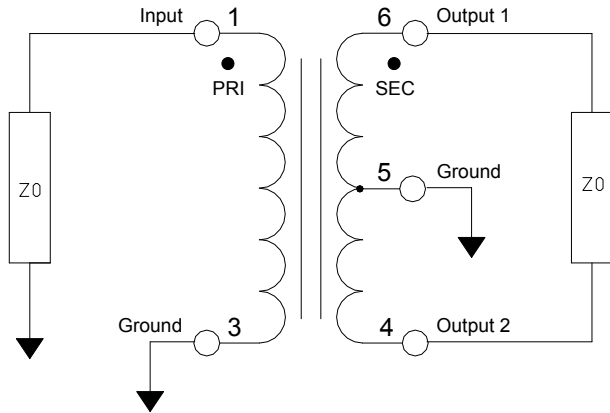

## PCB Layout

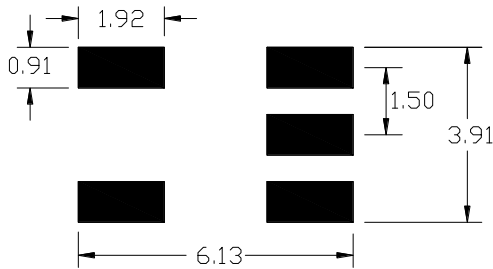

## Outline Drawing

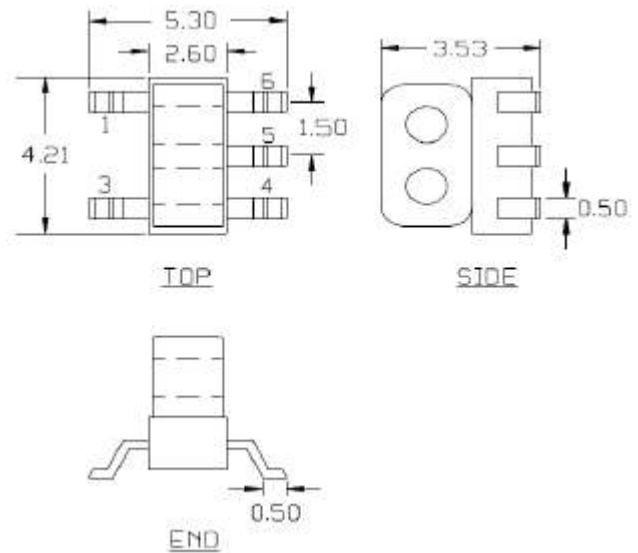

1. Dimensions in mm.
2. Tolerance:  $\pm 0.2$  mm unless otherwise noted.
3. Model number and lot code are printed on the reel.
4. Plating finish: CuSn6

## Tape & Reel Information

Parameter	Units	Value
Qty per reel	-	2000
Reel size	mm	330
Tape width (W)	mm	12.00
Pitch (P <sub>1</sub> )	mm	8.00
A <sub>0</sub>	mm	5.6
B <sub>0</sub>	mm	4.5
K <sub>0</sub>	mm	4.0
Orientation	-	F26
Reference Application note ANI-019 for orientation		

MACOM Technology Solutions Inc. All rights reserved.

Information in this document is provided in connection with MACOM Technology Solutions Inc ("MACOM") products. These materials are provided by MACOM as a service to its customers and may be used for informational purposes only. Except as provided in MACOM's Terms and Conditions of Sale for such products or in any separate agreement related to this document, MACOM assumes no liability whatsoever. MACOM assumes no responsibility for errors or omissions in these materials. MACOM may make changes to specifications and product descriptions at any time, without notice. MACOM makes no commitment to update the information and shall have no responsibility whatsoever for conflicts or incompatibilities arising from future changes to its specifications and product descriptions. No license, express or implied, by estoppel or otherwise, to any intellectual property rights is granted by this document.

THESE MATERIALS ARE PROVIDED "AS IS" WITHOUT WARRANTY OF ANY KIND, EITHER EXPRESS OR IMPLIED, RELATING TO SALE AND/OR USE OF MACOM PRODUCTS INCLUDING LIABILITY OR WARRANTIES RELATING TO FITNESS FOR A PARTICULAR PURPOSE, CONSEQUENTIAL OR INCIDENTAL DAMAGES, MERCHANTABILITY, OR INFRINGEMENT OF ANY PATENT, COPYRIGHT OR OTHER INTELLECTUAL PROPERTY RIGHT. MACOM FURTHER DOES NOT WARRANT THE ACCURACY OR COMPLETENESS OF THE INFORMATION, TEXT, GRAPHICS OR OTHER ITEMS CONTAINED WITHIN THESE MATERIALS. MACOM SHALL NOT BE LIABLE FOR ANY SPECIAL, INDIRECT, INCIDENTAL, OR CONSEQUENTIAL DAMAGES, INCLUDING WITHOUT LIMITATION, LOST REVENUES OR LOST PROFITS, WHICH MAY RESULT FROM THE USE OF THESE MATERIALS.

MACOM products are not intended for use in medical, lifesaving or life sustaining applications. MACOM customers using or selling MACOM products for use in such applications do so at their own risk and agree to fully indemnify MACOM for any damages resulting from such improper use or sale.