

C&K TF Series Miniature Snap-acting Switches

Features/Benefits

- Broad range of operating forces
- Ratings up to 25 AMPS
- Wide variety of actuator styles
- Quick connect, solder lug, PC and screw terminations

Typical Applications

- Motor controls
- Thermostatics
- Portable tools



Specifications

CONTACT RATING: From low level* to 25 AMPS @277 V AC.
 ELECTRICAL LIFE: 300,000 cycles at 10 AMPS @250 V AC, consult Customer Service Center for typical life of higher rated switches.
 INSULATION RESISTANCE: 1,000 M Ω min.
 DIELECTRIC STRENGTH: 1,500 Vrms min. @sea level.
 OPERATING TEMPERATURE: -40°F to 185°F (-40°C to 85°C).
 OPERATING FORCE: From 15 to 400 grams at actuator button available.
 MOUNTING: Torque screws 2-5 in/lbs.

* Low Level=conditions where no arcing occurs during switching, i.e., 0.4 VA max. @ 20 V AC or DC max. Standard electrical life per UL 1054, rated for 6,000 operations.

Materials

SWITCH HOUSING: Thermoplastic (UL 94V-0).
 ACTUATOR BUTTON: Thermoplastic (UL 94V-0).
 SPRING: Copper alloy.
 PIVOT: Brass alloy.
 MOVABLE CONTACTS: Gold alloy for ratings 1 AMP or less.
 Fine silver for ratings greater than 1 AMP up to 15 AMPS.
 Silver cadmium oxide for ratings greater than 15 AMPS.
 STATIONARY CONTACTS: Gold alloy for ratings 1 AMP or less.
 Fine silver for ratings greater than 1 AMP.
 TERMINALS: Brass alloy for ratings up to 10 AMPS.
 Copper alloy for ratings greater than 10 AMPS.

NOTE: Specifications and materials listed above are switches with standard options. For information on specific and custom switches, consult Customer Service Center.



Build-A-Switch

To order, simply select desired option from each category and place in the appropriate box. Available options are shown and described on pages J-6 thru J-11. For additional options not shown in catalog, consult Customer Service Center.

<p>Series</p> <p>TF (STD.) SP, Mom.</p> <p>Operating Force</p> <p>CJ (STD.) 5.29 oz./150 grams</p> <p>CC .53 oz./15 grams</p> <p>CD .88 oz./25 grams</p> <p>CF 1.76 oz./50 grams</p> <p>CG 2.65 oz./75 grams</p> <p>CH 4.23 oz./120 grams</p> <p>EC 7.94 oz./225 grams</p> <p>EE 14.11 oz./400 grams</p> <p>Electrical Rating</p> <p>J6 (STD.) 15 A, 277 V AC; 1/2 HP, 125, 250 V AC; 5 A, 125 V AC "L", 0.5 A, 125 V DC; 0.25 A, 250 V DC</p> <p>F5 1 A, 125 V AC; 1 A, 30 V DC</p> <p>H5 3 A, 277 V AC; 1/10 HP, 125, 250 V AC</p> <p>H8 5 A, 277 V AC; 1/10 HP, 125, 250 V AC</p> <p>J3 21 A, 277 V AC; 1 HP, 125 V AC; 2 HP, 250 V AC; 5 A, 125 V AC "L"</p> <p>K3 10 A, 277 V AC; 1/3 HP, 125, 250 V AC; 0.5 A, 125 V DC; 0.25 A, 250 V DC</p> <p>K6 11 A, 277 V AC; 1/3 HP, 125, 250 V AC; 0.5 A, 125 V DC; 0.25 A, 250 V DC</p> <p>L1 25 A, 277 V AC; 1.5 HP, 125 V AC; 2 HP, 250 V AC; 5 A, 125 V AC "L"</p> <p>L3 20 A, 250 V AC; 1 HP, 125 V AC; 2 HP 250 V AC</p> <p>V1 1 A, 125 V AC; 1 A, 30 V DC (UL/CSA)</p> <p>V2 5 A, 277 V AC; 1/10 HP, 125, 250 V AC (UL/CSA); 5(2) A, 250 V AC (VDE)</p> <p>V3 11 A, 277 V AC; 1/3 HP, 125, 250 V AC; 0.5 A, 125 V DC; 0.25 A, 250 V DC (UL/CSA); 10(3) A, 250 V AC (VDE)</p> <p>V4 21 A, 277 V AC; 1 HP, 125 V AC; 2 HP, 250 V AC; 5 A, 125 V AC "L"; 16(3) A, 250 V AC (VDE)</p>	<p>Mounting Style</p> <p>S (STD.)</p> <p>B Stackable cover, metric</p> <p>C Stackable base, metric</p> <p>M Stackable cover</p> <p>N Stackable base</p> <p>V Metric</p> <p>Actuator</p> <p>P00 (STD.) Pin plunger</p> <p>A10 .81" lever roller, high force</p> <p>A15 1.34" lever roller, high force</p> <p>A25 1.56" lever roller, low force</p> <p>T10 .84" lever, high force</p> <p>T13 1.34" simulated roller, high force</p> <p>T14 1.29" simulated roller, high force</p> <p>T15 1.40" lever, high force</p> <p>T16 2.34" lever, high force</p> <p>T18 2.75" lever, high force</p> <p>T20 1.10" lever, low force</p> <p>T23 1.56" simulated roller, low force</p> <p>T25 1.62" lever, low force</p> <p>T26 2.57" lever, low force</p> <p>WPO Wide pin plunger</p>	<p>Terminations</p> <p>40 (STD.) .187" quick connect</p> <p>4A .250" quick connect</p> <p>5A .250" offset quick connect</p> <p>5B .187" offset quick connect</p> <p>60 Screw</p> <p>73 Formed PC Thru-hole</p> <p>Circuitry</p> <p>C (STD.) SPDT</p> <p>W SPST N.C.</p> <p>Y SPST N.O.</p>
---	--	---

C&K TF Series Miniature Snap-acting Switches

ELECTRICAL RATING

OPTION CODE	CONTACT MATERIAL		INTERNATIONAL ELECTRICAL RATING   
	MOVABLE CONTACT	STATIONARY CONTACT	
V1	Gold alloy.	Gold alloy.	From low level* to 1 AMP @ 125 V AC; 1 AMP @ 30 V DC (UL/CSA). 0.1 (0.05) AMP @ 250 V~m T85 50E3 (VDE).
V2	Fine silver.	Fine silver.	5 AMPS @ 277 V AC; 1/10 HP @ 125 & 250 V AC (UL/CSA). 5 (2) AMPS @ 250 V~m T85 50E3 (VDE).
V3			11 AMPS @ 277 V AC; 1/3 HP @ 125 & 250 V AC; 0.5 AMP @ 125 V DC; 0.25 AMP @ 250 V DC (UL/CSA). 10 (3) AMPS @ 250 V~m 50E3 T85 (VDE).
V4	Silver Cadmium Oxide.	Fine silver.	21 AMPS @ 277 V AC; 1 HP @ 125 V AC; 2 HP @ 250 V AC; 16 (3) AMPS @ 250 V~m T85 10E3 (VDE).

NOTE: V1-V4 ratings available with '5A or 5B' terminal styles only.

INTERNATIONAL RATING SYMBOLS	
m	Microgap construction (less than 3 mm).
~	Alternating current.
T__	Maximum rated use temperature.
50E3	Cycles over 50,000 at rated current.
10E3	Cycles over 10,000 at rated current.
10(3)	First number represents resistive rating; second number represents inductive (motor) rating.

All models   with all options, .

Consult Customer Service center for availability and delivery of nonstandard ratings.

* Low Level=conditions where no arcing occurs during switching, i.e., 0.4 VA max. @20 V AC or DC max.

ELECTRICAL RATING	AMPS (REF.)	OPERATING FORCE							
		CC (15)	CD (25)	CF (50)	CG (75)	CH (120)	CJ (150)	EC (225)	EE (400)
F5	1	•	•	•	•	•	•	•	•
H5	3	•	•	•	•	•	•	•	•
H8	5	•	•	•	•	•	•	•	•
J3	21	x	x	x	x	x	•	•	•
J6	15	x	x	x	x	•	•	•	•
K3	10	x	x	•	•	x	•	•	•
K6	11	x	•	•	•	•	•	•	•
L1**	25	x	x	x	x	x	x	•	x
L3	20	x	x	x	x	•	•	•	x
V1	1	•	•	•	•	•	•	x	x
V2	5	x	x	•	•	•	•	•	•
V3	11	x	x	x	•	•	•	•	•
V4	16	x	x	x	x	x	•	•	•

• AVAILABLE

x NOT AVAILABLE

** Available with 4A & 5A terminations only, see page J-11.



Snap-acting

MOUNTING STYLE

S (STD.)
For 4-40 screw size

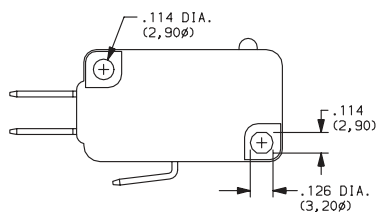

B STACKABLE COVER (METRIC)
For 3mm screw size

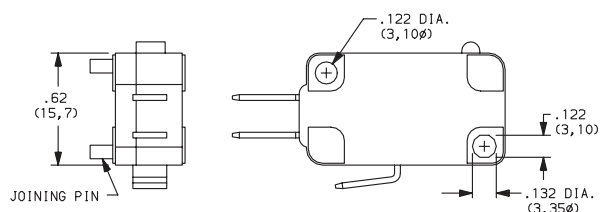

Third Angle Projection
Dimensions are shown: IN (mm)
Dimensions subject to change

C&K TF Series Miniature Snap-acting Switches

MOUNTING STYLE

C STACKABLE BASE (METRIC) – For end of stack.
For 3mm screw size

M STACKABLE COVER
For 4-40 screw size

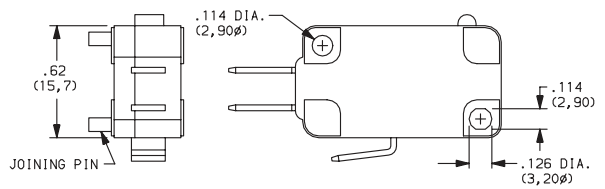
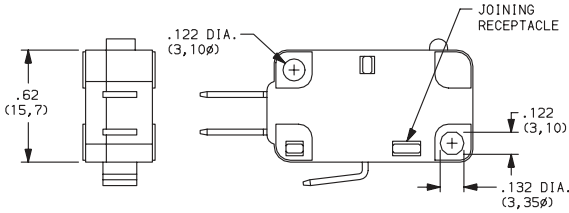

N STACKABLE BASE – For end of stack.
For 4-40 screw size

V (METRIC)
For 3mm screw size

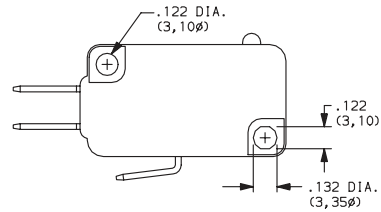
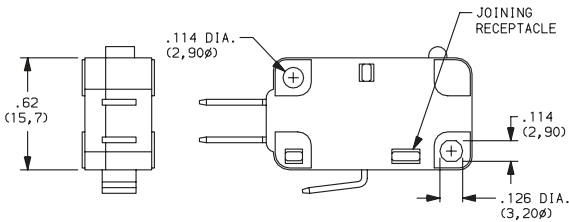

ACTUATOR

OPTION CODE	FIG.	DIM. A	DIM. B	DIM. C	DIM. D
P00 (STD.)	2	.80 (20,3)	—	.578 ± .015 (14,68 ± 0,38)	—
A10	1	.81 (20,6)	.32 (8,1)	.810 ± .020 (20,57 ± 0,51)	.19 dia. (4,8Ø)
A15	1	1.34 (34,0)	.32 (8,1)	.810 ± .030 (20,57 ± 0,76)	.19 dia. (4,8Ø)
A25	1	1.56 (39,6)	.54 (13,7)	.810 ± .075 (20,57 ± 1,91)	.19 dia. (4,8Ø)
T10	3	.84 (21,3)	.32 (8,1)	.600 ± .020 (15,24 ± 0,51)	—
T15	3	1.40 (35,6)	.32 (8,1)	.600 ± .040 (15,24 ± 1,02)	—
T16	3	2.34 (59,4)	.32 (8,1)	.600 ± .065 (15,24 ± 1,65)	—

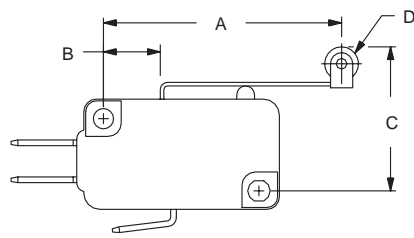

FIG. 1
Lever Roller

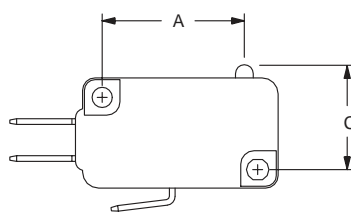

FIG. 2
Pin Plunger

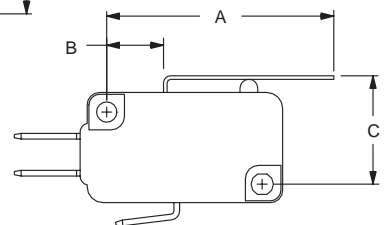

FIG. 3
Lever



Third Angle
Projection

Dimensions are shown: IN (mm)
Dimensions subject to change

Snap-acting

C&K TF Series Miniature Snap-acting Switches

ACTUATOR

SWITCH CHARACTERISTICS

OPTION CODE	MAXIMUM OPERATING FORCE (OZ./GRAMS)								MINIMUM RELEASE FORCE (OZ./GRAMS)								MAXIMUM DIFFERENTIAL TRAVEL	MAXIMUM PRETRAVEL	MINIMUM OVERTRAVEL
	CC	CD	CF	CG	CH	CJ	EC	EE	CC	CD	CF	CG	CH	CJ	EC	EE	ALL FORCES	ALL FORCES	ALL FORCES
T20	.53 15	.71 20	1.41 40	2.12 60	3.53 100	4.23 120	6 170	9.70 275	.21 6	.35 10	.35 10	.53 15	.71 20	.71 20	1.98 56	3.88 110	.030 (0,76)	.140 (3,56)	.060 (1,52)
T23	.18 5	.28 8	.56 16	.85 24	1.41 40	1.69 48	2.65 75	4.41 125	.04 1	.07 2	.07 2	.07 2	.14 4	.21 6	.35 10	.71 20	.050 (1,27)	.250 (6,35)	.120 (3,05)
T25	.18 5	.28 8	.53 15	.88 25	1.41 40	1.59 45	2.47 70	4.23 120	.04 1	.07 2	.07 2	.07 2	.14 4	.21 6	.35 10	.99 28	.055 (1,40)	.250 (6,35)	.125 (3,18)
T26	N/A	.14 4	.28 8	.42 12	.71 20	.85 24	1.27 36	2.26 64	N/A	.04 1	.04 1	.05 1.5	.11 3	.12 3.5	.21 6	.39 11	.100 (2,54)	.500 (12,70)	.235 (5,97)
WP0	.53 15	.88 25	1.76 50	2.65 75	4.23 120	5.29 150	7.94 225	14.11 400	.21 6	.35 10	.35 10	.53 15	.92 26	1.23 35	1.97 56	3.88 110	.010 (0,25)	.047 (1,19)	.030 (0,51)

NOTE: For basic switch operating forces, see page J-6.

HIGH FORCE, LOW MOTION PIVOT POSITION

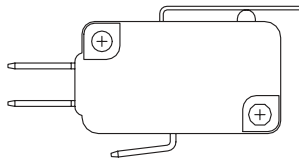

Available with actuators A10, A15, T10, T13, T14, T15, T16 and T18.

LOW FORCE, HIGH MOTION PIVOT POSITION

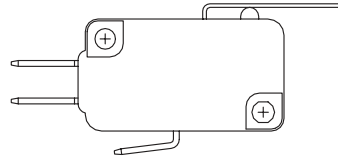

Available with actuators A25, T20, T23, T25 and T26.

NOTE: Lever actuator options are available in either of two pivot positions. Levers located in the forward pivot position have lower forces and higher motions. Levers located in the rear pivot position have higher forces and lower motions.

TERMINATIONS

40 (STD.) .187" QUICK CONNECT

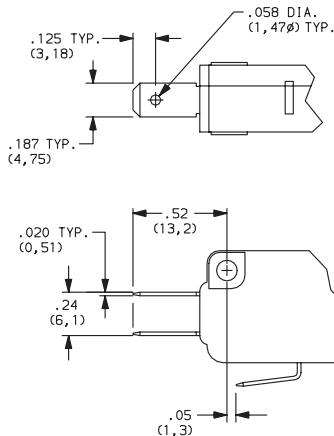

60 SCREW TERMINALS

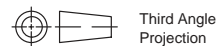
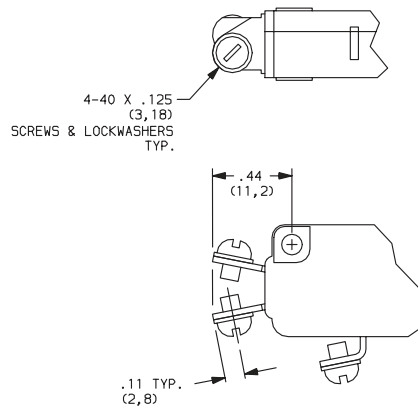

Third Angle Projection
Dimensions are shown: IN (mm)
Dimensions subject to change

C&K TF Series Miniature Snap-acting Switches

TERMINATIONS

4A .250" QUICK CONNECT

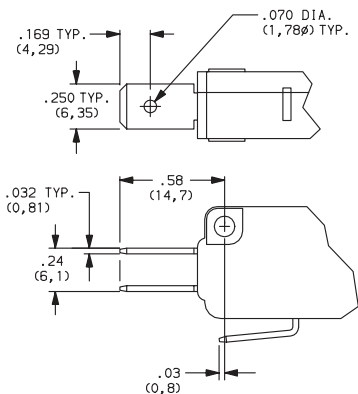

5A OFFSET .250" QUICK CONNECT

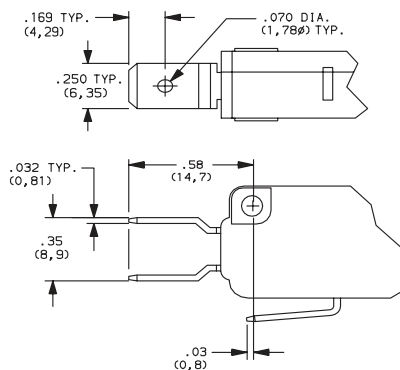

5B OFFSET .187" QUICK CONNECT

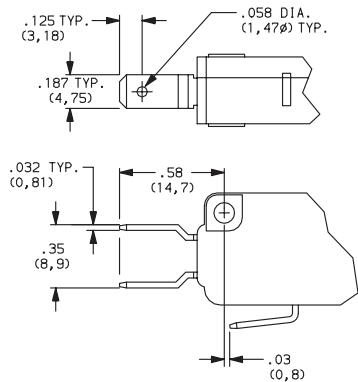

73 FORMED PC THRU-HOLE

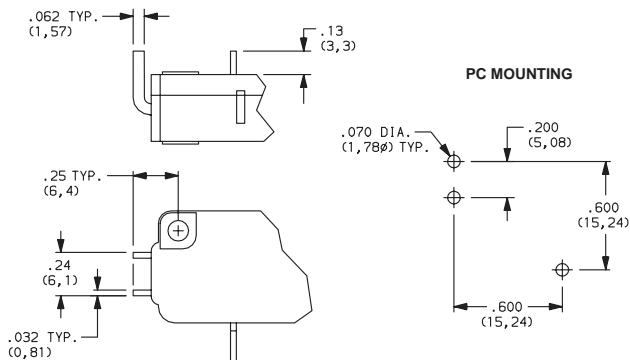

CIRCUITRY

- C** (STD.) SPDT (Single Pole, Double Throw)
- W** SPST N.C. (Single Pole, Single Throw, Normally Closed)
- Y** SPST N.O. (Single Pole, Single Throw, Normally Open)

Snap-acting