

6 CAP POSITION WITH RESPECT TO CONNECTOR

FOR CKT 10 & BELOW & CKT 14, 18, 22, 26, 30, 34, 38, 42, 46, 50, 54, 58, 62, 66, 70, 74, 78, 82, 86, 90, 94, 98

FOR 12, 16, 20, 24, 28, 32, 36, 40, 44, 48, 52, 56, 60, 64, 68, 72, 76, 80, 84, 86, 92, 96, 100

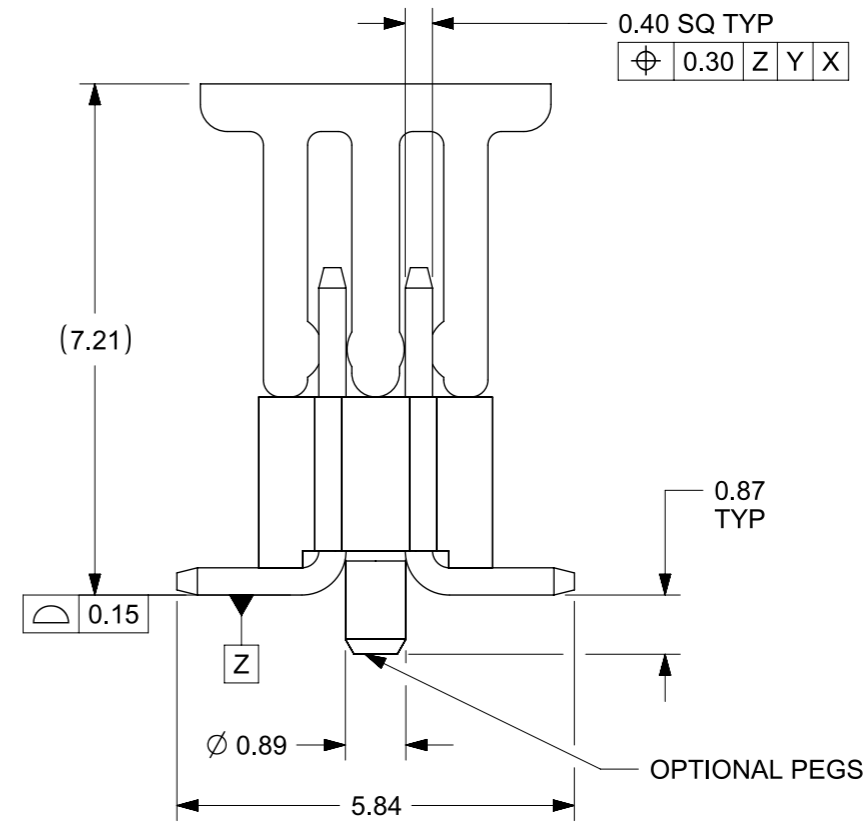
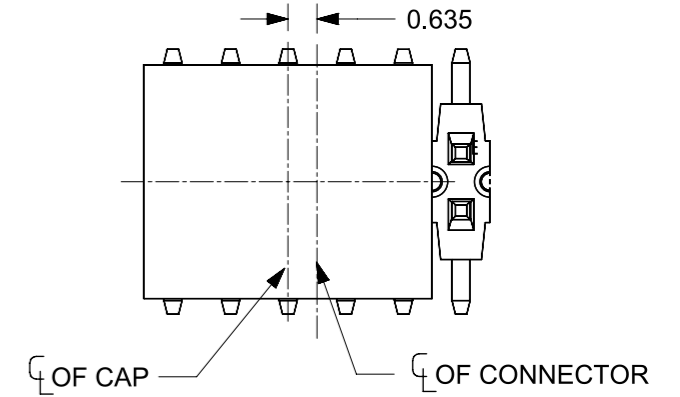
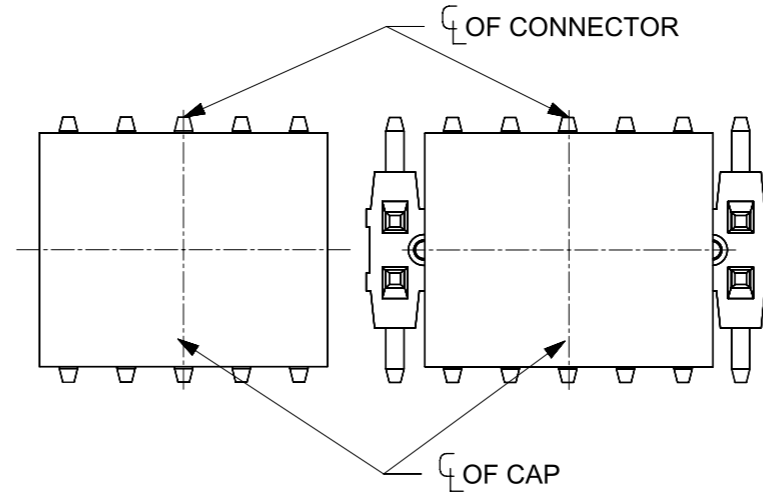

THIS DRAWING CONTAINS INFORMATION THAT IS PROPRIETARY TO MOLEX ELECTRONIC TECHNOLOGIES, LLC AND SHOULD NOT BE USED WITHOUT WRITTEN PERMISSION											
DIMENSION UNITS		SCALE		CURRENT REV DESC:							
mm		NTS									
GENERAL TOLERANCES (UNLESS SPECIFIED)											
ANGULAR TOL $\pm 3.0^\circ$											
4 PLACES		$\pm$		EC NO: 743277							
3 PLACES		$\pm$		DRWN: DANUSA		2022/11/18					
2 PLACES		$\pm 0.2$		CHK'D: SUAIFR		2023/03/22					
1 PLACE		$\pm$		APPR: MRAMAKRISHNA		2023/03/23					
0 PLACES		$\pm$		INITIAL REVISION:							
				DRWN: SCHEONG		2016/09/14					
				APPR: SCHEONG		2016/11/10					
DRAFT WHERE APPLICABLE MUST REMAIN WITHIN DIMENSIONS				THIRD ANGLE PROJECTION		DRAWING		SERIES		MATERIAL NUMBER	
						A3-SIZE		87933		SEE TABLE	
						CUSTOMER		GENERAL MARKET		SHEET NUMBER	
										1 OF 6	

**molex**

1.27MM PITCH SMT HEADER WITH CAP PACKED IN TUBE

PRODUCT CUSTOMER DRAWING

DOCUMENT NUMBER	DOC TYPE	DOC PART	REVISION
SD-87933-0001	PSD	000	C5

CKT SIZE	DIM A	DIM B	DIM C
4	2.54	1.27	-
6	3.81	2.54	-
8	5.08	3.81	-
10	6.35	5.08	3.81
12	7.62	6.35	-
14	8.89	7.62	-
16	10.16	8.89	-
18	11.43	10.16	-
20	12.70	11.43	10.16
22	13.97	12.70	-
24	15.24	13.97	-

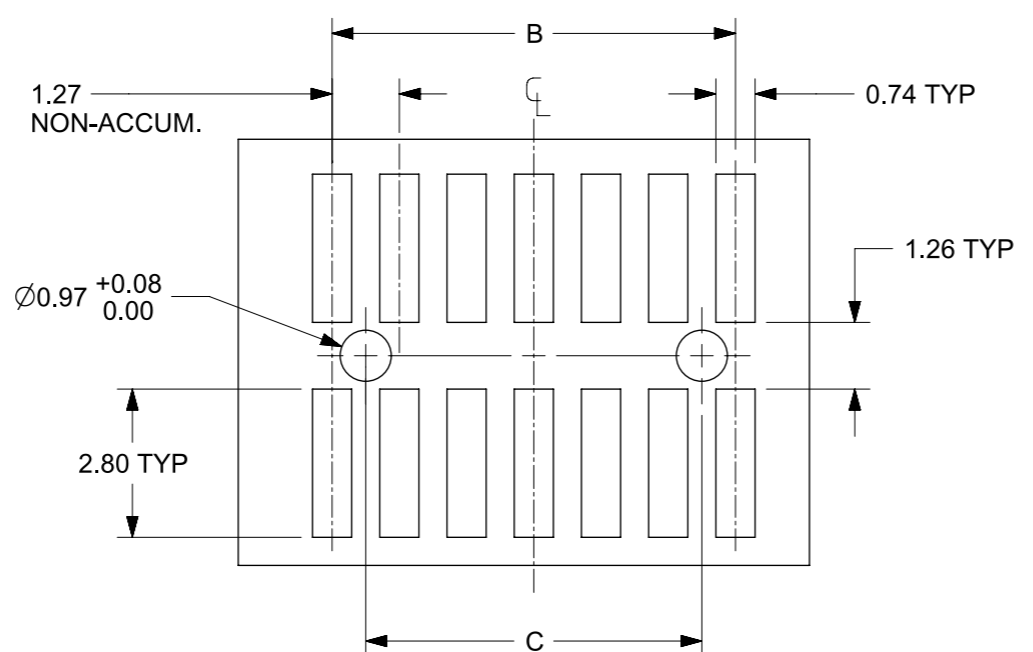

RECOMMENDED PCB LAYOUT  
(PARTS WITH PEGS)  
MANUFACTURING TOLERANCE ±0.05

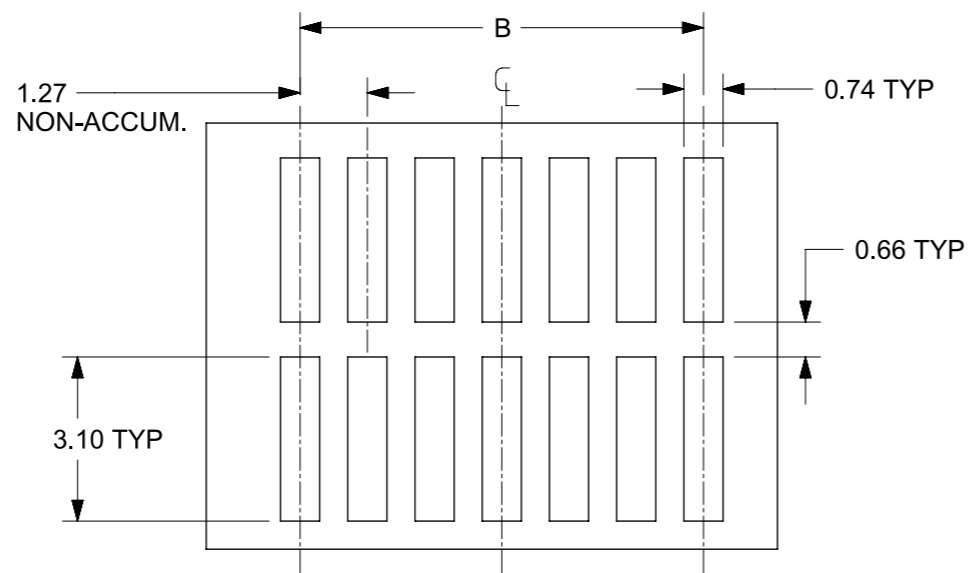

RECOMMENDED PCB LAYOUT  
(IMPROVED FOR WITHOUT PEGS OPTION)  
MANUFACTURING TOLERANCE ±0.05

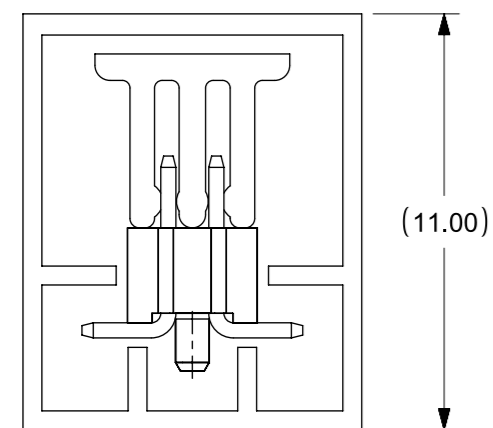

PART WITH PEG & CAP  
PACKED IN TUBE

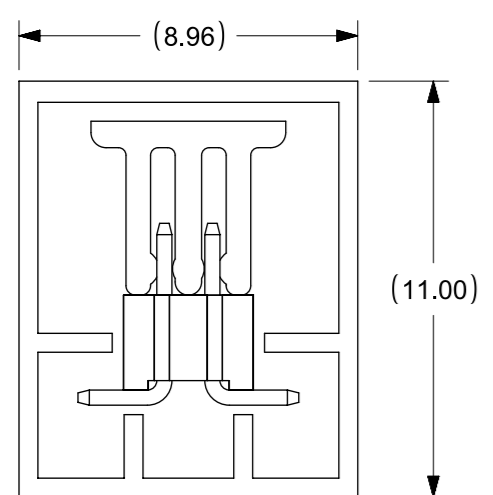



PART WITHOUT PEG &  
WITH CAP PACKED IN TUBE

NOTE:

- MATERIAL: HOUSING: LCP GLASS FILLED, COLOR: BLACK  
TERMINAL: COPPER ALLOY
- PIN PUSHOUT FORCE: 0.4KG MIN. IN EITHER DIRECTION.
- PLATING FINISH:
  - 2 MICRO INCH MIN. GOLD FLASH OVERALL, 50 MICRO INCH MIN. NICKEL UNDERPLATED
  - 100 MICRO INCH MIN. TIN OVERALL, 50 MICRO INCH MIN. NICKEL UNDERPLATED
  - 30 MICRO INCH MIN. GOLD PLATE IN SELECTED AREA AND 80 MICRO INCH MIN. TIN IN SELECTED AREA OVER, 50 MICRO INCH MIN. NICKEL UNDERPLATED
  - 15 MICRO INCH MIN. GOLD PLATE IN SELECTED AREA AND 80 MICRO INCH MIN. TIN IN SELECTED AREA OVER, 50 MICRO INCH MIN. NICKEL UNDERPLATED
  - 2 MICRO INCH MIN. GOLD FLASH IN SELECTED AREA AND 100 MICRO INCH MIN. TIN IN SELECTED AREA OVER, 50 MICRO INCH MIN. NICKEL UNDERPLATED
- THE ABOVE 14 CKT SHOWN IS FOR ILLUSTRATION ONLY.
- PARTS TO BE PACKED IN TUBE EXCEPT FOR 4 CKTS.
- POSITION OF CAP TO BE LOCATED AS SHOWN.
- IRREGULAR CIRCUIT CUTOFF WITHIN BREAKAWAY SECTION IS PERMISSIBLE. CUTTING OR CHIPPING OF THE MAIN BODY IS NOT ACCEPTABLE.
- PACKAGING SPECIFICATION REFER TO  
TUBE : PK-89990-565  
TAPE & REEL : PK-87933-300
- PRODUCT SPECIFICATION: 879330001\_PS
- MATED SERIES: 78120 EXCEPT FOR FULL TIN PLATING FINISH
- PARTS CONFORMS TO CLASS "B" REQUIREMENT TO COSMETIC SPECIFICATION PS-45499-002

THIS DRAWING CONTAINS INFORMATION THAT IS PROPRIETARY TO MOLEX ELECTRONIC TECHNOLOGIES, LLC AND SHOULD NOT BE USED WITHOUT WRITTEN PERMISSION											
DIMENSION UNITS		SCALE		CURRENT REV DESC:				<b>molex</b>			
mm		NTS									
GENERAL TOLERANCES (UNLESS SPECIFIED)				EC NO: 743277 DRWN: DANUSA 2022/11/18 CHK'D: SUAIFR 2023/03/22 APPR: MRAMAKRISHNA 2023/03/23 INITIAL REVISION: DRWN: SCHEONG 2016/09/14 APPR: SCHEONG 2016/11/10				1.27MM PITCH SMT HEADER WITH CAP PACKED IN TUBE			
ANGULAR TOL ± 3.0°								PRODUCT CUSTOMER DRAWING			
4 PLACES ±								DOCUMENT NUMBER		DOC TYPE	
3 PLACES ±								SD-87933-0001		PSD	
2 PLACES ±		0.2						DOC PART		REVISION	
1 PLACE ±				000		C5					
0 PLACES ±				MATERIAL NUMBER		CUSTOMER					
DRAFT WHERE APPLICABLE MUST REMAIN WITHIN DIMENSIONS		THIRD ANGLE PROJECTION		DRAWING		SERIES		SHEET NUMBER			
				A3-SIZE		87933		2 OF 6			

10		9		8		7		6		5		4		3		2		1	
P/N WITH CAP PACKED IN T&R	TOOLED	NOT TOOLED	P/N WITH CAP PACKED IN TUBE	PEG	CKT SIZE	PLATING OPTIONS	DIM. M	P/N WITH CAP PACKED IN T&R	TOOLED	NOT TOOLED	P/N WITH CAP PACKED IN TUBE	P/N WITHOUT CAP PACKED IN T&R	PEG	CKT SIZE	PLATING OPTIONS	DIM. M			
87933-0422		X	-	N	04	1	1.65	87933-0828		X	87933-0818	-	N	08	4	3.05			
87933-0438		X	-	N	04	2	1.65	87933-0824	X		87933-0823	-	N	08	5	3.05			
87933-0439		X	-	N	04	3	1.65	87933-1022	X		87933-1007	-	N	10	1	1.65			
87933-0440		X	-	N	04	4	1.65	87933-1038	X		87933-1008	-	N	10	2	1.65			
87933-0446		X	-	N	04	5	1.65	87933-1039	X		87933-1009	-	N	10	3	1.65			
87933-0441		X	-	N	04	1	1.91	87933-1040	X		87933-1010	-	N	10	4	1.65			
87933-0442		X	-	N	04	2	1.91	87933-1046	X		87933-1045	-	N	10	5	1.65			
87933-0443		X	-	N	04	3	1.91	87933-1041	X		87933-1011	-	N	10	1	1.91			
87933-0444		X	-	N	04	4	1.91	87933-1042	X		87933-1012	-	N	10	2	1.91			
87933-0448		X	-	N	04	5	1.91	87933-1043	X		87933-1013	-	N	10	3	1.91			
87933-0425		X	-	N	04	1	3.05	87933-1044	X		87933-1014	-	N	10	4	1.91			
87933-0426		X	-	N	04	2	3.05	87933-1048	X		87933-1047	-	N	10	5	1.91			
87933-0427		X	-	N	04	3	3.05	87933-1025	X		87933-1015	-	N	10	1	3.05			
87933-0428		X	-	N	04	4	3.05	87933-1026	X		87933-1016	-	N	10	2	3.05			
87933-0424		X	-	N	04	5	3.05	87933-1021	X		87933-1017	-	N	10	3	3.05			
87933-0622	X		87933-0607	N	06	1	1.65	87933-1028	X		87933-1018	C5 87933-1058	N	10	4	3.05			
87933-0638	X		87933-0608	N	06	2	1.65	87933-1024	X		87933-1023	-	N	10	5	3.05			
87933-0639	X		87933-0609	N	06	3	1.65	87933-1237		X	87933-1252	-	N	12	1	1.65			
87933-0640	X		87933-0610	N	06	4	1.65	87933-1238		X	87933-1258	-	N	12	2	1.65			
87933-0646	X		87933-0645	N	06	5	1.65	87933-1239		X	87933-1259	-	N	12	3	1.65			
87933-0641	X		87933-0611	N	06	1	1.91	87933-1240		X	87933-1260	-	N	12	4	1.65			
87933-0642	X		87933-0612	N	06	2	1.91	87933-1246		X	87933-1245	-	N	12	5	1.65			
87933-0643	X		87933-0613	N	06	3	1.91	87933-1241		X	87933-1261	-	N	12	1	1.91			
87933-0644	X		87933-0614	N	06	4	1.91	87933-1242		X	87933-1262	-	N	12	2	1.91			
87933-0648	X		87933-0647	N	06	5	1.91	87933-1243		X	87933-1263	-	N	12	3	1.91			
87933-0625	X		87933-0615	N	06	1	3.05	87933-1244		X	87933-1264	-	N	12	4	1.91			
87933-0626	X		87933-0616	N	06	2	3.05	87933-1248		X	87933-1247	-	N	12	5	1.91			
87933-0627	X		87933-0617	N	06	3	3.05	87933-1225		X	87933-1219	-	N	12	1	3.05			
87933-0628	X		87933-0618	N	06	4	3.05	87933-1229		X	87933-1220	-	N	12	2	3.05			
87933-0624	X		87933-0623	N	06	5	3.05	87933-1227		X	87933-1221	-	N	12	3	3.05			
87933-0822		X	87933-0807	N	08	1	1.65	87933-1232		X	87933-1222	-	N	12	4	3.05			
87933-0838		X	87933-0808	N	08	2	1.65	87933-1224		X	87933-1223	-	N	12	5	3.05			
87933-0839		X	87933-0809	N	08	3	1.65												
87933-0840		X	87933-0810	N	08	4	1.65												
87933-0846		X	87933-0845	N	08	5	1.65												
87933-0841		X	87933-0811	N	08	1	1.91												
87933-0842		X	87933-0812	N	08	2	1.91												
87933-0843		X	87933-0813	N	08	3	1.91												
87933-0844		X	87933-0814	N	08	4	1.91												
87933-0848		X	87933-0847	N	08	5	1.91												
87933-0825		X	87933-0815	N	08	1	3.05												
87933-0826		X	87933-0816	N	08	2	3.05												
87933-0827		X	87933-0817	N	08	3	3.05												

THIS DRAWING CONTAINS INFORMATION THAT IS PROPRIETARY TO MOLEX ELECTRONIC TECHNOLOGIES, LLC AND SHOULD NOT BE USED WITHOUT WRITTEN PERMISSION									
DIMENSION UNITS		SCALE		CURRENT REV DESC:					
mm		NTS		 <p>1.27MM PITCH SMT HEADER WITH CAP PACKED IN TUBE</p> <p>PRODUCT CUSTOMER DRAWING</p>					
GENERAL TOLERANCES (UNLESS SPECIFIED)									
ANGULAR TOL ± 3.0°									
4 PLACES ±		EC NO: 743277							
3 PLACES ±		DRWN: DANUSA 2022/11/18							
2 PLACES ± 0.2		CHK'D: SUAIFR 2023/03/22							
1 PLACE ±		APPR: MRAMAKRISHNA 2023/03/23							
0 PLACES ±		INITIAL REVISION:							
DRAFT WHERE APPLICABLE MUST REMAIN WITHIN DIMENSIONS		THIRD ANGLE PROJECTION		DRAWING		SERIES		DOCUMENT NUMBER	
				A3-SIZE		87933		SD-87933-0001	
								PSD 000 C5	
								SEE TABLE GENERAL MARKET	
								SHEET NUMBER 3 OF 6	

10	9	8	7	6			
P/N WITH CAP PACKED IN T&R	TOOLED	NOT TOOLED	P/N WITH CAP PACKED IN TUBE	PEG	CKT SIZE	PLATING OPTIONS	DIM. M
87933-1422		X	87933-1407	N	14	1	1.65
87933-1438		X	87933-1408	N	14	2	1.65
87933-1439		X	87933-1409	N	14	3	1.65
87933-1440		X	87933-1410	N	14	4	1.65
87933-1446		X	87933-1445	N	14	5	1.65
87933-1441		X	87933-1411	N	14	1	1.91
87933-1442		X	87933-1412	N	14	2	1.91
87933-1443		X	87933-1413	N	14	3	1.91
87933-1444		X	87933-1414	N	14	4	1.91
87933-1448		X	87933-1447	N	14	5	1.91
87933-1425		X	87933-1415	N	14	1	3.05
87933-1426		X	87933-1416	N	14	2	3.05
87933-1427		X	87933-1417	N	14	3	3.05
87933-1428		X	87933-1418	N	14	4	3.05
87933-1424		X	87933-1423	N	14	5	3.05
87933-1622		X	87933-1607	N	16	1	1.65
87933-1638		X	87933-1608	N	16	2	1.65
87933-1639		X	87933-1609	N	16	3	1.65
87933-1640		X	87933-1610	N	16	4	1.65
87933-1646		X	87933-1645	N	16	5	1.65
87933-1641		X	87933-1611	N	16	1	1.91
87933-1642		X	87933-1612	N	16	2	1.91
87933-1643		X	87933-1613	N	16	3	1.91
87933-1644		X	87933-1614	N	16	4	1.91
87933-1648		X	87933-1647	N	16	5	1.91
87933-1625		X	87933-1615	N	16	1	3.05
87933-1626		X	87933-1616	N	16	2	3.05
87933-1627		X	87933-1617	N	16	3	3.05
87933-1628		X	87933-1618	N	16	4	3.05
87933-1624		X	87933-1623	N	16	5	3.05
87933-1822		X	87933-1807	N	18	1	1.65
87933-1838		X	87933-1808	N	18	2	1.65
87933-1839		X	87933-1809	N	18	3	1.65
87933-1840		X	87933-1810	N	18	4	1.65
87933-1846		X	87933-1845	N	18	5	1.65
87933-1841		X	87933-1811	N	18	1	1.91
87933-1842		X	87933-1812	N	18	2	1.91
87933-1843		X	87933-1813	N	18	3	1.91
87933-1844		X	87933-1814	N	18	4	1.91
87933-1848		X	87933-1847	N	18	5	1.91
87933-1825		X	87933-1815	N	18	1	3.05
87933-1826		X	87933-1816	N	18	2	3.05
87933-1827		X	87933-1817	N	18	3	3.05

5	4	3	2	1			
P/N WITH CAP PACKED IN T&R	TOOLED	NOT TOOLED	P/N WITH CAP PACKED IN TUBE	PEG	CKT SIZE	PLATING OPTIONS	DIM. M
87933-1828	X		87933-1818	N	18	4	3.05
87933-1824	X		87933-1823	N	18	5	3.05
87933-2037	X		87933-2007	N	20	1	1.65
87933-2038	X		87933-2008	N	20	2	1.65
87933-2039	X		87933-2009	N	20	3	1.65
87933-2040	X		87933-2010	N	20	4	1.65
87933-2046	X		87933-2045	N	20	5	1.65
87933-2041	X		87933-2011	N	20	1	1.91
87933-2042	X		87933-2012	N	20	2	1.91
87933-2043	X		87933-2013	N	20	3	1.91
87933-2044	X		87933-2014	N	20	4	1.91
87933-2048	X		87933-2047	N	20	5	1.91
87933-2025	X		87933-2015	N	20	1	3.05
87933-2026	X		87933-2016	N	20	2	3.05
87933-2027	X		87933-2017	N	20	3	3.05
87933-2021	X		87933-2018	N	20	4	3.05
87933-2024	X		87933-2023	N	20	5	3.05
87933-2237		X	87933-2207	N	22	1	1.65
87933-2238		X	87933-2208	N	22	2	1.65
87933-2239		X	87933-2209	N	22	3	1.65
87933-2240		X	87933-2210	N	22	4	1.65
87933-2246		X	87933-2245	N	22	5	1.65
87933-2241		X	87933-2211	N	22	1	1.91
87933-2242		X	87933-2212	N	22	2	1.91
87933-2243		X	87933-2213	N	22	3	1.91
87933-2244		X	87933-2214	N	22	4	1.91
87933-2248		X	87933-2247	N	22	5	1.91
87933-2225		X	87933-2215	N	22	1	3.05
87933-2226		X	87933-2216	N	22	2	3.05
87933-2227		X	87933-2217	N	22	3	3.05
87933-2228		X	87933-2218	N	22	4	3.05
87933-2224		X	87933-2223	N	22	5	3.05

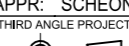
THIS DRAWING CONTAINS INFORMATION THAT IS PROPRIETARY TO MOLEX ELECTRONIC TECHNOLOGIES, LLC AND SHOULD NOT BE USED WITHOUT WRITTEN PERMISSION														
DIMENSION UNITS		SCALE		CURRENT REV DESC:										
mm		NTS												
GENERAL TOLERANCES (UNLESS SPECIFIED)				EC NO: 743277 DRWN: DANUSA 2022/11/18 CHK'D: SUAIFR 2023/03/22 APPR: MRAMAKRISHNA 2023/03/23				1.27MM PITCH SMT HEADER WITH CAP PACKED IN TUBE						
ANGULAR TOL ± 3.0°														
4 PLACES ±								PRODUCT CUSTOMER DRAWING						
3 PLACES ±														
2 PLACES ± 0.2								INITIAL REVISION: DRWN: SCHEONG 2016/09/14 APPR: SCHEONG 2016/11/10		DOCUMENT NUMBER		DOC TYPE	DOC PART	REVISION
1 PLACE ±										SD-87933-0001		PSD	000	C5
0 PLACES ±						MATERIAL NUMBER		CUSTOMER		SHEET NUMBER				
DRAFT WHERE APPLICABLE MUST REMAIN WITHIN DIMENSIONS				THIRD ANGLE PROJECTION		DRAWING	SERIES	GENERAL MARKET		4 OF 6				
						A3-SIZE	87933							

10	9	8	7	6	5	4	3	2	1
P/N WITH CAP PACKED IN T&R	TOOLED	NOT TOOLED	P/N WITH CAP PACKED IN TUBE	PEG	CKT SIZE	PLATING OPTIONS	DIM. M		
87933-2437		X	87933-2407	N	24	1	1.65		
87933-2438		X	87933-2408	N	24	2	1.65		
87933-2439		X	87933-2409	N	24	3	1.65		
87933-2440		X	87933-2410	N	24	4	1.65		
87933-2446		X	87933-2445	N	24	5	1.65		
87933-2441		X	87933-2411	N	24	1	1.91		
87933-2442		X	87933-2412	N	22	2	1.91		
87933-2443		X	87933-2413	N	24	3	1.91		
87933-2444		X	87933-2414	N	24	4	1.91		
87933-2448		X	87933-2447	N	24	5	1.91		
87933-2425		X	87933-2415	N	24	1	3.05		
87933-2426		X	87933-2416	N	24	2	3.05		
87933-2427		X	87933-2417	N	24	3	3.05		
87933-2428		X	87933-2418	N	24	4	3.05		
87933-2424		X	87933-2423	N	24	5	3.05		

THIS DRAWING CONTAINS INFORMATION THAT IS PROPRIETARY TO MOLEX ELECTRONIC TECHNOLOGIES, LLC AND SHOULD NOT BE USED WITHOUT WRITTEN PERMISSION												
DIMENSION UNITS		SCALE		CURRENT REV DESC:				<b>molex</b>		1.27MM PITCH SMT HEADER WITH CAP PACKED IN TUBE		
mm		NTS										
GENERAL TOLERANCES (UNLESS SPECIFIED)				EC NO: 743277 DRWN: DANUSA 2022/11/18 CHK'D: SUAIFR 2023/03/22 APPR: MRAMAKRISHNA 2023/03/23				PRODUCT CUSTOMER DRAWING				
ANGULAR TOL ± 3.0 °												
4 PLACES		±		INITIAL REVISION: DRWN: SCHEONG 2016/09/14 APPR: SCHEONG 2016/11/10				DOCUMENT NUMBER		DOC TYPE	DOC PART	REVISION
3 PLACES		±						SD-87933-0001		PSD	000	C5
2 PLACES		± 0.2		DRAFT WHERE APPLICABLE MUST REMAIN WITHIN DIMENSIONS				MATERIAL NUMBER		CUSTOMER		SHEET NUMBER
1 PLACE		±						A3-SIZE		87933		SEE TABLE
0 PLACES		±		THIRD ANGLE PROJECTION		DRAWING		SERIES				

DOCUMENT STATUS	P1	RELEASE DATE	2023/03/23	05:13:54
-----------------	----	--------------	------------	----------

BOARD TO BOARD (BTB) DISTANCE

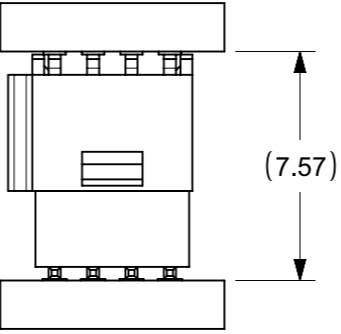
HEADER	MATES WITH (RECEPTACLE)	BTB DIST.	PICTORIAL VIEW
87933	78120	7.57	

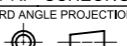
THIS DRAWING CONTAINS INFORMATION THAT IS PROPRIETARY TO MOLEX ELECTRONIC TECHNOLOGIES, LLC AND SHOULD NOT BE USED WITHOUT WRITTEN PERMISSION											
DIMENSION UNITS	SCALE	CURRENT REV DESC:									
mm	NTS										
GENERAL TOLERANCES (UNLESS SPECIFIED)		EC NO: 743277 DRWN: DANUSA 2022/11/18 CHK'D: SUAIFR 2023/03/22 APPR: MRAMAKRISHNA 2023/03/23				1.27MM PITCH SMT HEADER WITH CAP PACKED IN TUBE					
ANGULAR TOL	± 3.0 °					PRODUCT CUSTOMER DRAWING					
4 PLACES	±					INITIAL REVISION:		DOCUMENT NUMBER	DOC TYPE	DOC PART	REVISION
3 PLACES	±					DRWN: SCHEONG 2016/09/14		SD-87933-0001	PSD	000	C5
2 PLACES	± 0.2					APPR: SCHEONG 2016/11/10					
1 PLACE	±			MATERIAL NUMBER		CUSTOMER		SHEET NUMBER			
0 PLACES	±			A3-SIZE	87933	SEE TABLE	GENERAL MARKET	6 OF 6			
DRAFT WHERE APPLICABLE MUST REMAIN WITHIN DIMENSIONS		THIRD ANGLE PROJECTION		DRAWING		SERIES					
											

DOCUMENT STATUS	P1	RELEASE DATE	2023/03/23 05:13:54
-----------------	----	--------------	---------------------