

XSAV12801L10

Inductive proximity sensors XS, Rotation monitoring, M30, Sn10mm, 120...3000c/mn, 24...240VAC/DC, cable 10 m



Main

Range of Product	Telemecanique Inductive proximity sensors XS
Series name	Application
Product or Component Type	Sensor
Sensor Type	Inductive proximity sensor
Device Application	Rotation monitoring
Sensor name	XSA
Sensor design	Cylindrical M30
Size	81 mm
Body type	Fixed
Detector flush mounting acceptance	Flush mountable
Material	Metal
Enclosure Material	Nickel Plated Brass
Type of output signal	Discrete
Wiring Technique	2-wire
[Sn] nominal sensing distance	0.39 in (10 mm)
Discrete output function	1 NC
Output circuit type	AC/DC
Electrical connection	Cable
Cable length	32.81 ft (10 m)
[Us] rated supply voltage	24...210 V DC 24...240 V AC 50/60 Hz
Switching capacity in mA	5...200 mA DC 5...350 mA AC
IP degree of protection	IP67 conforming to IEC 60529

Complementary

Thread type	M30 x 1.5
Detection face	Frontal
Front material	PPS
Sensing range	> 0.31...0.59 in (> 8...15 mm)
Adjustable frequency range	120...3000 cyc/mn
Operating zone	0.00...0.31 in (0...8 mm)
Differential travel	3...15% of Fr
Repeat accuracy	3% of Sr
Cable composition	2 x 0.34 mm ²
Wire insulation material	PvR
Status LED	Output state 1 LED red)
Supply voltage limits	20...264 V AC/DC
Maximum residual current	1.5 mA open state
Switching frequency	<= 800 Hz
Maximum voltage drop	<5.7 V closed)
Run-up delay at power-up	9 s standard
Marking	CE

The information provided in this documentation contains general descriptions and/or technical characteristics of the performance of the products contained herein. This documentation is not intended as a substitute for and is not to be used for determining suitability or reliability of these products for specific user applications. It is the duty of any such user or integrator to perform the appropriate and complete risk analysis, evaluation and testing of the products with respect to the relevant specific application or use thereof. Neither Schneider Electric Industries SAS nor any of its affiliates or subsidiaries shall be responsible or liable for misuse of the information contained herein.

Threaded length	2.64 in (67 mm)
Length	3.19 in (81 mm)
Net Weight	0.66 lb(US) (0.3 kg)

Environment

Product Certifications	CCC UL CSA
Ambient Air Temperature for Operation	-13...158 °F (-25...70 °C)
Ambient Air Temperature for Storage	-40...185 °F (-40...85 °C)





Ordering and shipping details

Category	22486-SENSORS, PROXIMITY
Discount Schedule	DS2
GTIN	3389110125467
Nbr. of units in pkg.	1
Package weight(Lbs)	14.89 oz (422.0 g)
Returnability	No
Country of origin	FR

Packing Units

Unit Type of Package 1	PCE
Package 1 Height	5.91 in (15 cm)
Package 1 width	3.86 in (9.8 cm)
Package 1 Length	3.62 in (9.2 cm)
Unit Type of Package 2	S02
Number of Units in Package 2	7
Package 2 Weight	7.40 lb(US) (3.356 kg)
Package 2 Height	5.91 in (15 cm)
Package 2 width	11.81 in (30 cm)
Package 2 Length	15.75 in (40 cm)

Offer Sustainability

Sustainable offer status	Green Premium product
California proposition 65	WARNING: This product can expose you to chemicals including: Diisononyl phthalate (DINP), which is known to the State of California to cause cancer, and Di-isodecyl phthalate (DIDP), which is known to the State of California to cause birth defects or other reproductive harm. For more information go to www.P65Warnings.ca.gov
REACH Regulation	 REACH Declaration
EU RoHS Directive	Pro-active compliance (Product out of EU RoHS legal scope)  EU RoHS Declaration
Mercury free	Yes
RoHS exemption information	 Yes
Environmental Disclosure	 Product Environmental Profile
Circularity Profile	 End Of Life Information

Contractual warranty

Warranty	18 months
----------	-----------

Dimensions

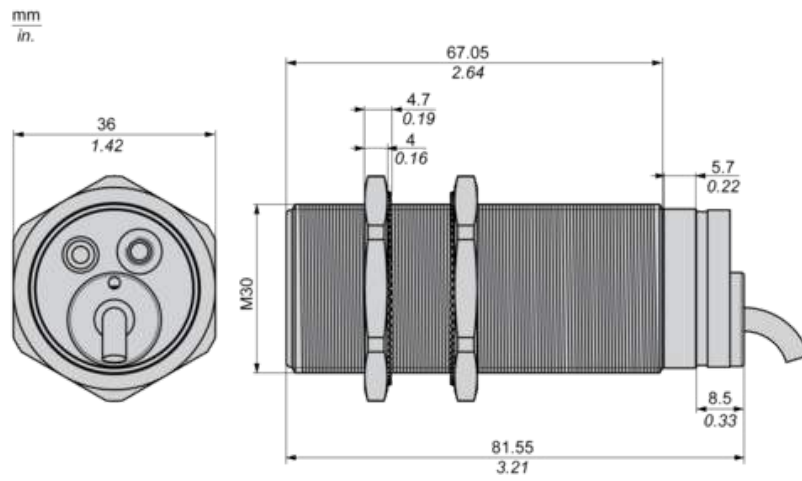

Minimum Mounting Distances

Side by side

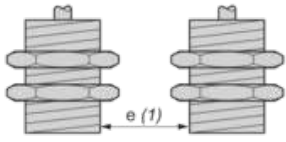

$e (1) \geq 20 \text{ mm}/0.79 \text{ in}$

Face to face

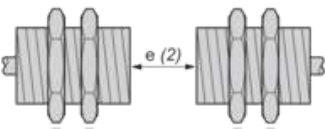

$e (2) \geq 120 \text{ mm}/4.72 \text{ in}$

Facing a metal object

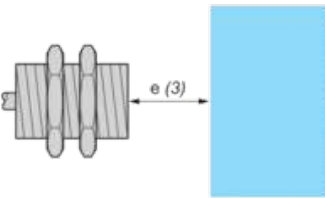

$e (3) \geq 30 \text{ mm}/1.18 \text{ in}$.

Wiring Schemes

2-wire AC or DC

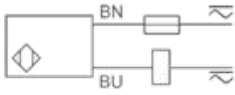

BU : Blue

BN : Brown

Performance Curves

Standard Steel Target : 30x30x1 mm

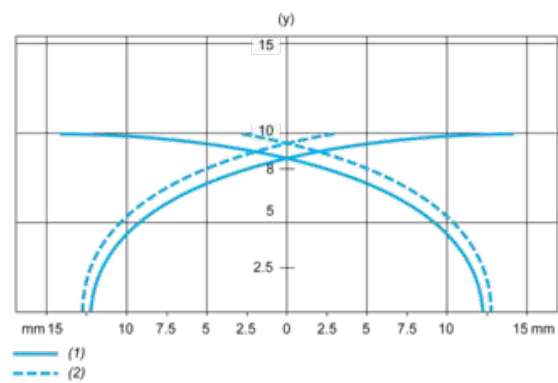

(1) Pick-up points

(2) Drop-out points (object approaching from the side)

(y) Sensing distance in mm