

## MOSFET

### 600V CoolMOS™ SJ S7 Power Device

IPP60R022S7 enables the best price performance for low frequency switching applications. CoolMOS™ S7 boasts the lowest  $R_{DS(on)}$  values for a HV SJ MOSFET, with distinctive increase of energy efficiency.

CoolMOS™ S7 is optimized for “static switching” and high current applications. It is an ideal fit for solid state relay and circuit breaker designs as well as for line rectification in SMPS and inverter topologies.

### Features

- CoolMOS™ S7 technology enables  $22\text{m}\Omega$   $R_{DS(on)}$  in the smallest footprint
- Optimized price performance in low frequency switching applications
- High pulse current capability
- TO220 package with total Pb-free die attach

### Benefits

- Minimized conduction losses (eliminate / reduce heat sink)
- Increased system performance
- More compact and easier design
- Lower BOM or/and TCO over prolonged life time

Compared to electromechanical devices:

- Faster switching times
- More reliability and longer system life time
- Shock & Vibration resistance
- No contact arcing, bouncing or degradation over life time

### Potential applications

- Solid state relays and circuit breakers
- Line rectification in high power/performance applications e.g. Computing, Telecom, UPS and Solar

### Product validation

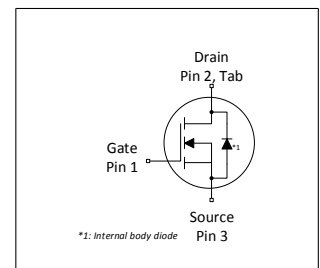
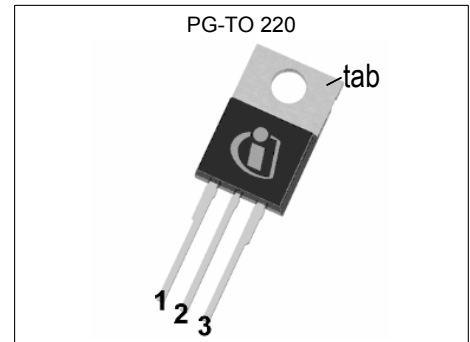
Fully qualified according to JEDEC for Industrial Applications

*Please note: For MOSFET paralleling the use of ferrite beads on the gate or separate totem poles is generally recommended.*

**Table 1 Key Performance Parameters**

Parameter	Value	Unit
$R_{DS(on),max}$	22	$\text{m}\Omega$
$Q_{g,typ}$	150	nC
$V_{SD}$	0.83	V
Pulsed $I_{SD}, I_{DS}$	375	A

Type / Ordering Code	Package	Marking	Related Links
IPP60R022S7	PG-TO220-3	60R022S7	see Appendix A



RoHS

## Table of Contents

Description .....	1
Maximum ratings .....	3
Thermal characteristics .....	4
Electrical characteristics .....	5
Electrical characteristics diagrams .....	7
Test Circuits .....	11
Package Outlines .....	12
Appendix A .....	13
Revision History .....	14
Trademarks .....	14
Disclaimer .....	14

## 1 Maximum ratings

at  $T_j = 25^\circ\text{C}$ , unless otherwise specified

**Table 2 Maximum ratings**

Parameter	Symbol	Values			Unit	Note / Test Condition
		Min.	Typ.	Max.		
Drain current rating	$I_D$	-	-	23	A	$T_C=140^\circ\text{C}$ Current is limited by $T_{j\max} = 150^\circ\text{C}$ ; Lower case temp does increase current capability
Pulsed drain current <sup>1)</sup>	$I_{D,\text{pulse}}$	-	-	375	A	$T_C=25^\circ\text{C}$
Avalanche energy, single pulse	$E_{AS}$	-	-	289	mJ	$I_D=3.8\text{A}$ ; $V_{DD}=50\text{V}$ ; see table 10
Avalanche current, single pulse	$I_{AS}$	-	-	3.8	A	-
MOSFET dv/dt ruggedness <sup>2)</sup>	dv/dt	-	-	20	V/ns	$V_{DS}= 0\text{V to }300\text{V}$
Gate source voltage (static)	$V_{GS}$	-20	-	20	V	static
Gate source voltage (dynamic)	$V_{GS}$	-30	-	30	V	AC ( $f>1\text{ Hz}$ )
Power dissipation	$P_{\text{tot}}$	-	-	390	W	$T_C=25^\circ\text{C}$
Storage temperature	$T_{\text{stg}}$	-55	-	150	$^\circ\text{C}$	-
Operating junction temperature	$T_j$	-55	-	150	$^\circ\text{C}$	-
Mounting torque	-	-	-	60	Ncm	M3 and M3.5 screws
Diode forward current rating	$I_S$	-	-	23	A	$T_C=140^\circ\text{C}$ Current is limited by $T_{j\max} = 150^\circ\text{C}$ ; Lower case temp does increase current capability
Diode pulse current <sup>1)</sup>	$I_{S,\text{pulse}}$	-	-	375	A	$T_C=25^\circ\text{C}$
Reverse diode dv/dt <sup>3)</sup>	dv/dt	-	-	5	V/ns	$V_{DS}=0\text{ to }300\text{V}$ , $I_{SD}\leq 23\text{A}$ , $T_j=25^\circ\text{C}$ see table 8
Maximum diode commutation speed	di/dt	-	-	820	A/ $\mu\text{s}$	$V_{DS}=0\text{ to }300\text{V}$ , $I_{SD}\leq 23\text{A}$ , $T_j=25^\circ\text{C}$ see table 8
Insulation withstand voltage	$V_{\text{ISO}}$	-	-	n.a.	V	$V_{\text{rms}}$ , $T_C=25^\circ\text{C}$ , $t=1\text{min}$

<sup>1)</sup> Pulse width  $t_p$  limited by  $T_{j\max}$

<sup>2)</sup> The dv/dt has to be limited by appropriate gate resistor

<sup>3)</sup> Identical low side and high side switch

## 2 Thermal characteristics

**Table 3 Thermal characteristics**

Parameter	Symbol	Values			Unit	Note / Test Condition
		Min.	Typ.	Max.		
Thermal resistance, junction - case	$R_{thJC}$	-	-	0.32	°C/W	-
Thermal resistance, junction - ambient	$R_{thJA}$	-	-	62	°C/W	leaded
Thermal resistance, junction - ambient for SMD version	$R_{thJA}$	-	-	-	°C/W	n.a.
Soldering temperature, wavesoldering only allowed at leads	$T_{sold}$	-	-	260	°C	1.6mm (0.063 in.) from case for 10s

### 3 Electrical characteristics

at  $T_j=25^\circ\text{C}$ , unless otherwise specified

**Table 4 Static characteristics**

For applications with applied blocking voltage >70% of the specified blocking voltage, it is required that the customer evaluates the impact of cosmic radiation effect in early design phase and contacts the Infineon sales office for the necessary technical support by Infineon

Parameter	Symbol	Values			Unit	Note / Test Condition
		Min.	Typ.	Max.		
Drain-source breakdown voltage	$V_{(BR)DSS}$	600	-	-	V	$V_{GS}=0V, I_D=1mA$
Gate threshold voltage	$V_{(GS)th}$	3.5	4.0	4.5	V	$V_{DS}=V_{GS}, I_D=1.44mA$
Zero gate voltage drain current	$I_{DSS}$	-	-	5	$\mu A$	$V_{DS}=600V, V_{GS}=0V, T_j=25^\circ C$ $V_{DS}=600V, V_{GS}=0V, T_j=150^\circ C$
Gate-source leakage current	$I_{GSS}$	-	-	100	nA	$V_{GS}=20V, V_{DS}=0V$
Drain-source on-state resistance	$R_{DS(on)}$	-	0.02	0.022	$\Omega$	$V_{GS}=12V, I_D=23A, T_j=25^\circ C$ $V_{GS}=12V, I_D=23A, T_j=150^\circ C$
Gate resistance	$R_G$	-	0.80	-	$\Omega$	$f=1MHz, \text{open drain}$

**Table 5 Dynamic characteristics**

Parameter	Symbol	Values			Unit	Note / Test Condition
		Min.	Typ.	Max.		
Input capacitance	$C_{iss}$	-	5639	-	pF	$V_{GS}=0V, V_{DS}=300V, f=250kHz$
Output capacitance	$C_{oss}$	-	89	-	pF	$V_{GS}=0V, V_{DS}=300V, f=250kHz$
Effective output capacitance, energy related <sup>1)</sup>	$C_{o(er)}$	-	303	-	pF	$V_{GS}=0V, V_{DS}=0 \text{ to } 300V$
Effective output capacitance, time related <sup>2)</sup>	$C_{o(tr)}$	-	2678	-	pF	$I_D=\text{constant}, V_{GS}=0V, V_{DS}=0 \text{ to } 300V$
Output charge	$Q_{oss}$	-	803	-	nC	$V_{GS}=0V, V_{DS}=0 \text{ to } 300V$
Turn-on delay time	$t_{d(on)}$	-	30	-	ns	$V_{DD}=300V, V_{GS}=13V, I_D=23A, R_G=5.3\Omega; \text{ see table 9}$
Rise time	$t_r$	-	9	-	ns	$V_{DD}=300V, V_{GS}=13V, I_D=23A, R_G=5.3\Omega; \text{ see table 9}$
Turn-off delay time	$t_{d(off)}$	-	150	-	ns	$V_{DD}=300V, V_{GS}=13V, I_D=23A, R_G=5.3\Omega; \text{ see table 9}$
Fall time	$t_f$	-	9	-	ns	$V_{DD}=300V, V_{GS}=13V, I_D=23A, R_G=5.3\Omega; \text{ see table 9}$

**Table 6 Gate charge characteristics**

Parameter	Symbol	Values			Unit	Note / Test Condition
		Min.	Typ.	Max.		
Gate to source charge	$Q_{gs}$	-	31	-	nC	$V_{DD}=300V, I_D=23A, V_{GS}=0 \text{ to } 12V$
Gate to drain charge	$Q_{gd}$	-	50	-	nC	$V_{DD}=300V, I_D=23A, V_{GS}=0 \text{ to } 12V$
Gate charge total	$Q_g$	-	150	-	nC	$V_{DD}=300V, I_D=23A, V_{GS}=0 \text{ to } 12V$
Gate plateau voltage	$V_{plateau}$	-	5.4	-	V	$V_{DD}=300V, I_D=23A, V_{GS}=0 \text{ to } 12V$

<sup>1)</sup>  $C_{o(er)}$  is a fixed capacitance that gives the same stored energy as  $C_{oss}$  while  $V_{DS}$  is rising from 0 to 300V

<sup>2)</sup>  $C_{o(tr)}$  is a fixed capacitance that gives the same charging time as  $C_{oss}$  while  $V_{DS}$  is rising from 0 to 300V

**Table 7 Reverse diode characteristics**

Parameter	Symbol	Values			Unit	Note / Test Condition
		Min.	Typ.	Max.		
Diode forward voltage	$V_{SD}$	-	0.83	-	V	$V_{GS}=0V, I_F=23A, T_j=25^\circ C$
Reverse recovery time	$t_{rr}$	-	460	-	ns	$V_R=300V, I_F=23A, di_F/dt=100A/\mu s$ ; see table 8
Reverse recovery charge	$Q_{rr}$	-	9	-	$\mu C$	$V_R=300V, I_F=23A, di_F/dt=100A/\mu s$ ; see table 8
Peak reverse recovery current	$I_{rrm}$	-	40	-	A	$V_R=300V, I_F=23A, di_F/dt=100A/\mu s$ ; see table 8

## 4 Electrical characteristics diagrams

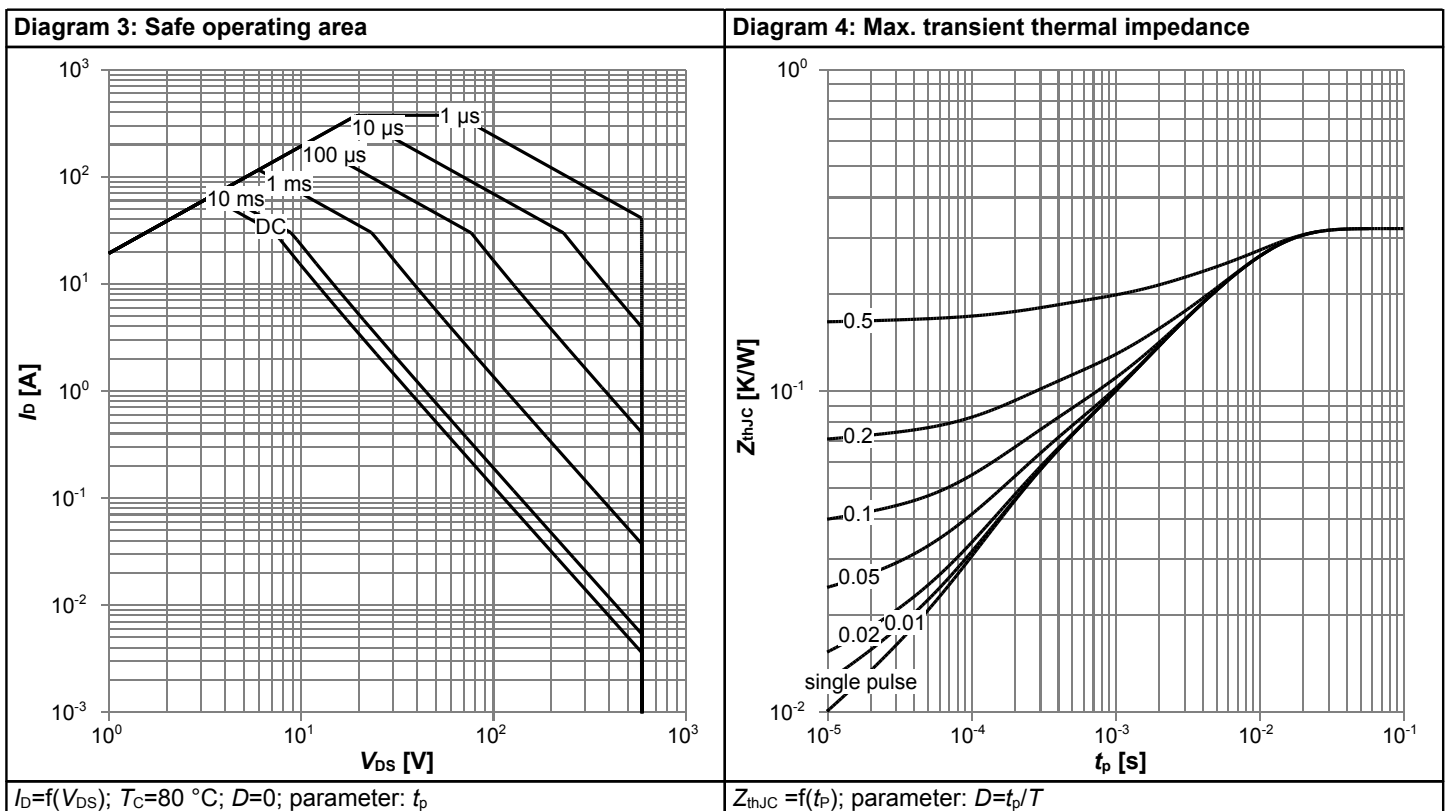
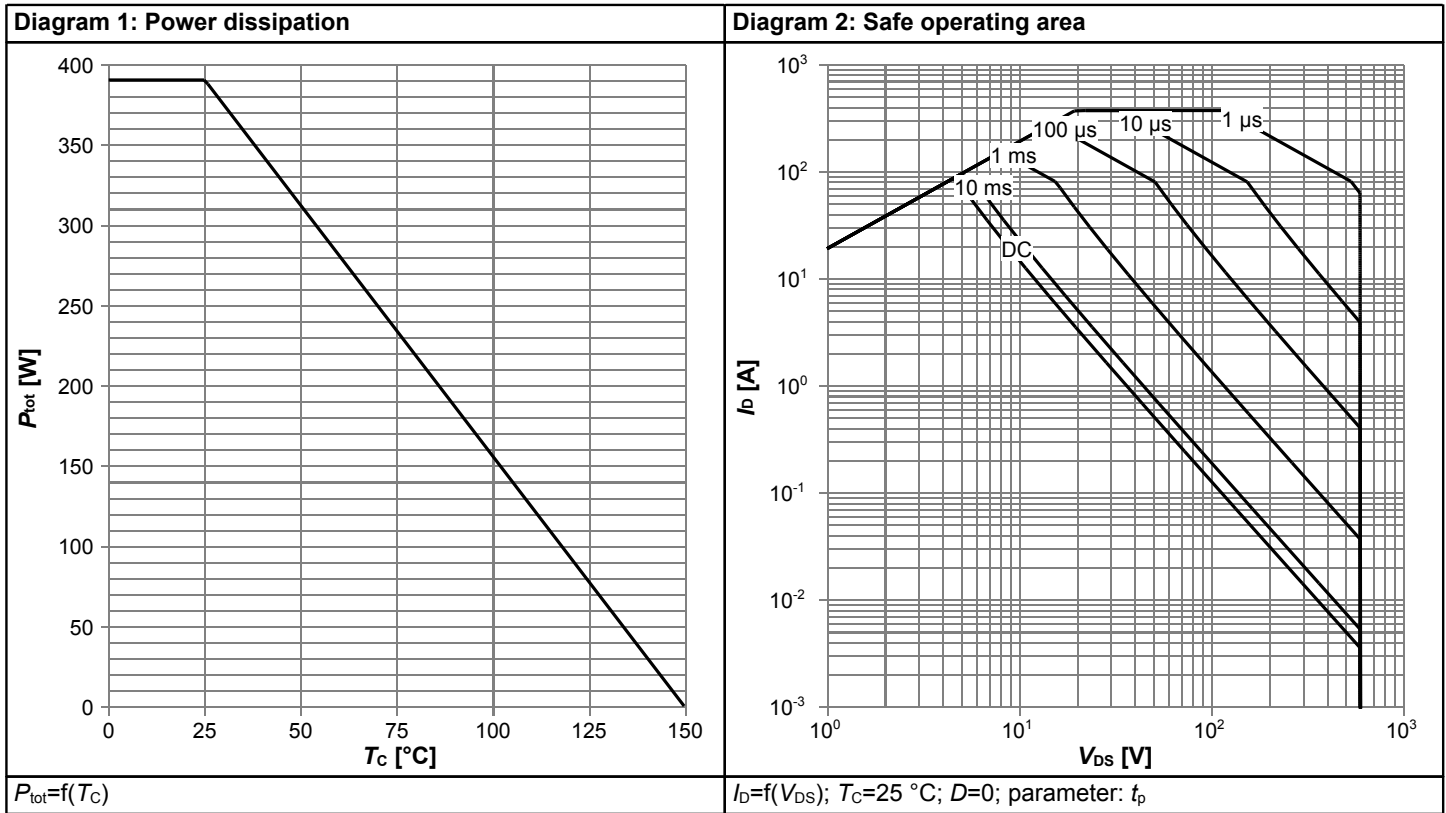
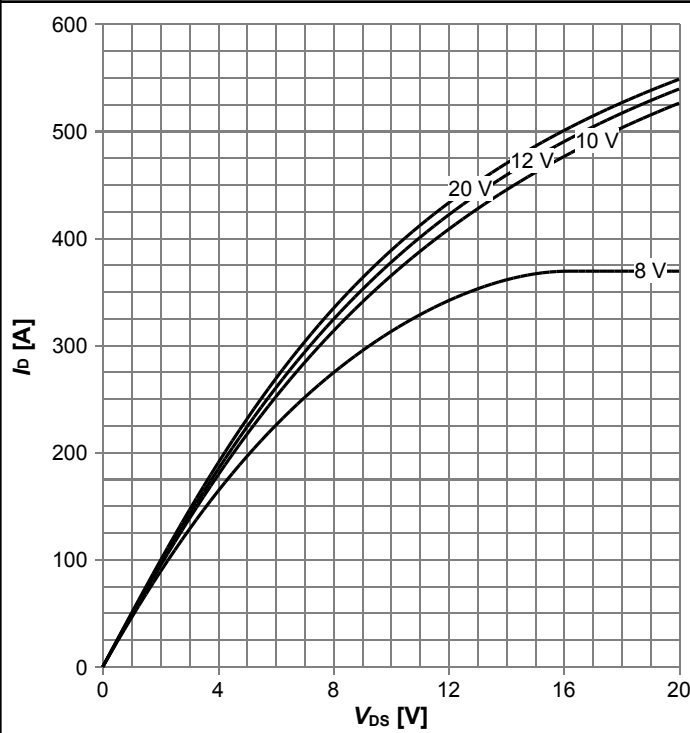
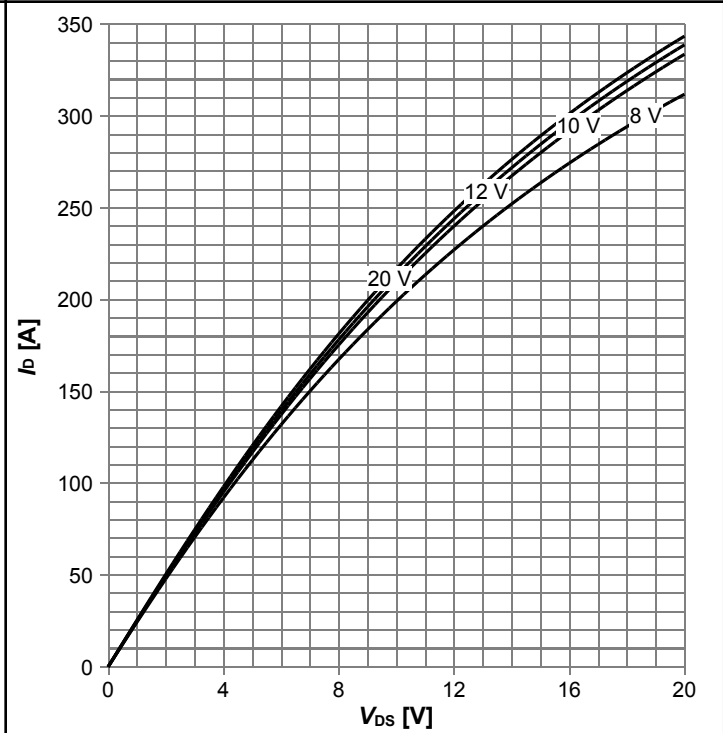


Diagram 5: Typ. output characteristics



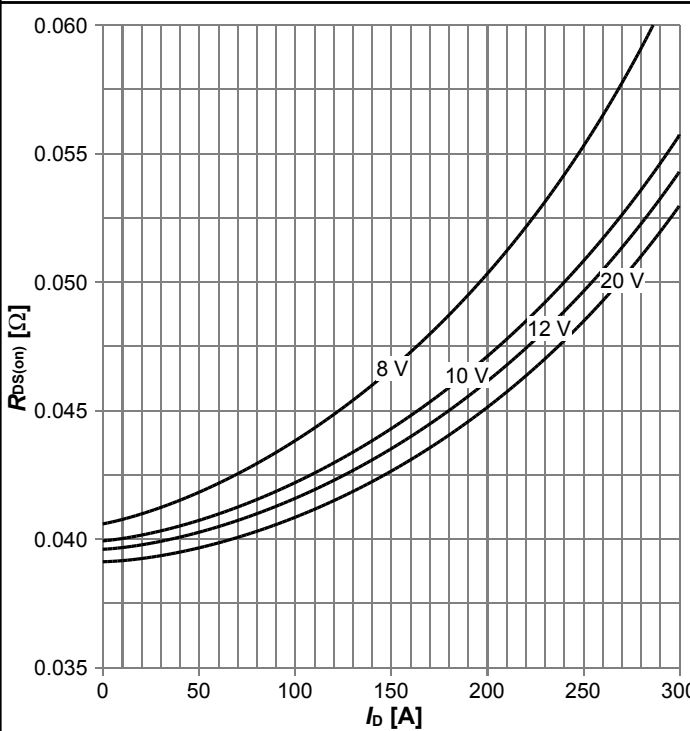
$I_D=f(V_{DS}); T_j=25\text{ }^\circ\text{C};$  parameter:  $V_{GS}$

Diagram 6: Typ. output characteristics



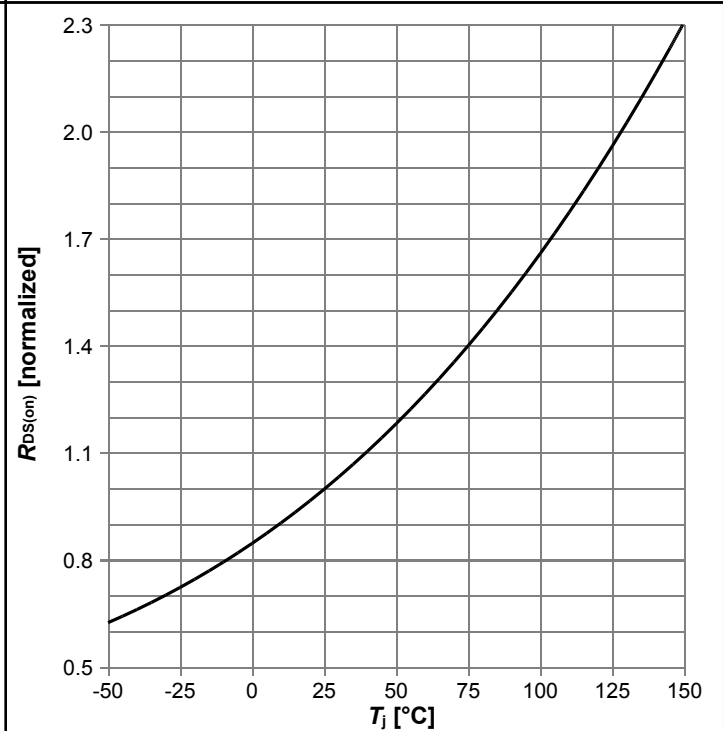
$I_D=f(V_{DS}); T_j=125\text{ }^\circ\text{C};$  parameter:  $V_{GS}$

Diagram 7: Typ. drain-source on-state resistance



$R_{DS(on)}=f(I_D); T_j=125\text{ }^\circ\text{C};$  parameter:  $V_{GS}$

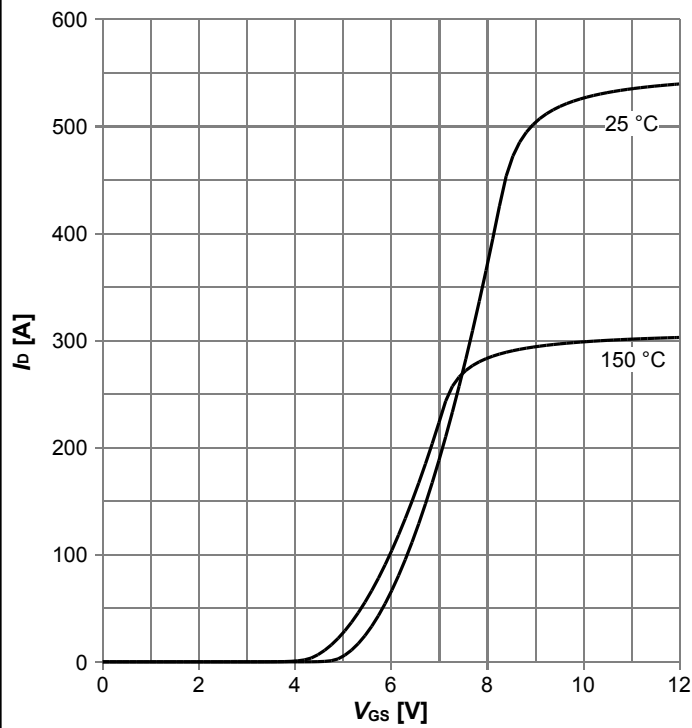
Diagram 8: Drain-source on-state resistance



$R_{DS(on)}=f(T_j); I_D=23.0\text{ A}; V_{GS}=12\text{ V}$

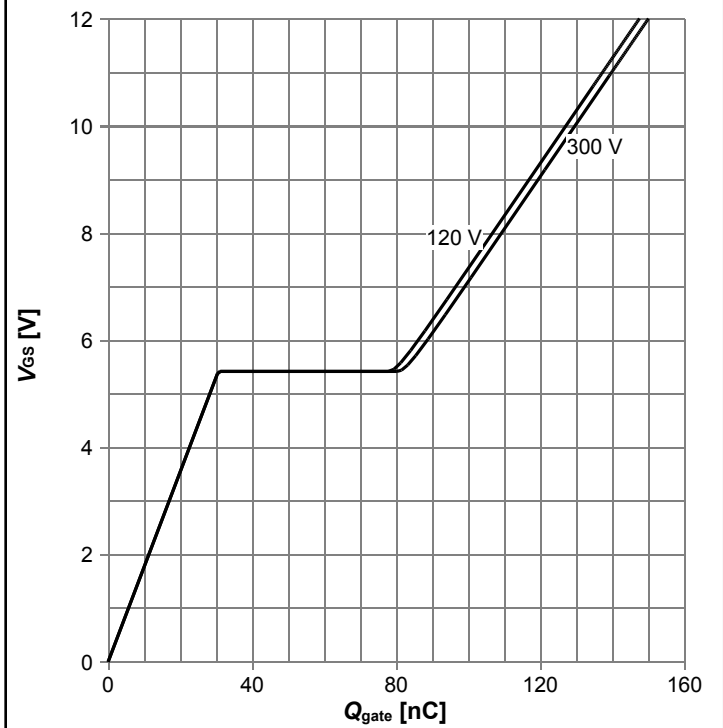


Diagram 9: Typ. transfer characteristics



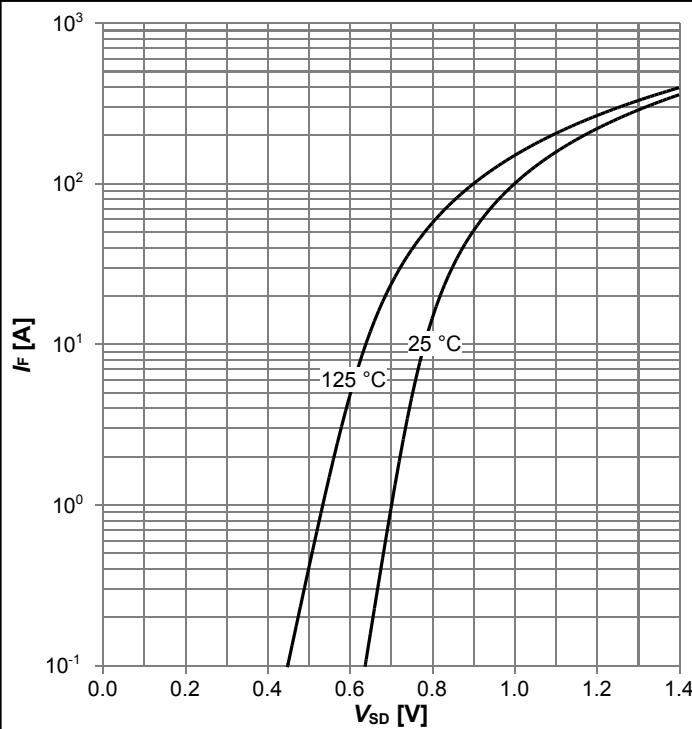
$I_D = f(V_{GS})$ ;  $V_{DS} = 20V$ ; parameter:  $T_j$

Diagram 10: Typ. gate charge



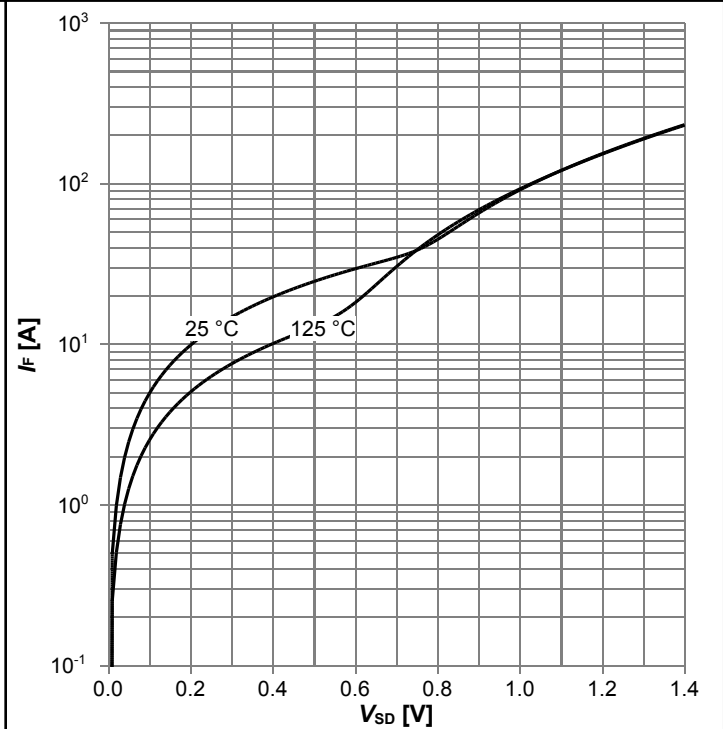
$V_{GS} = f(Q_{gate})$ ;  $I_D = 23.0 A$  pulsed; parameter:  $V_{DD}$

Diagram 11: Forward characteristics of reverse diode



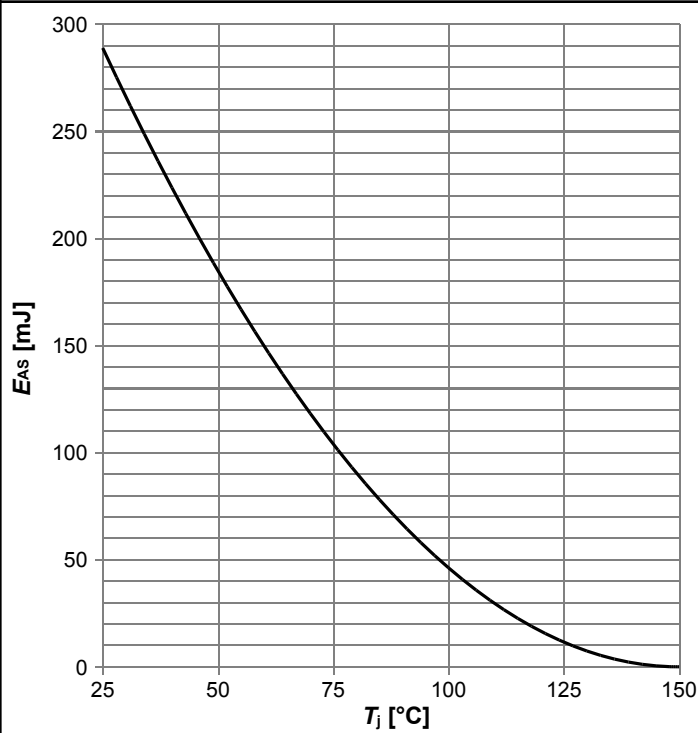
$I_F = f(V_{SD})$ ;  $V_{GS} = 0 V$ ; parameter:  $T_j$

Diagram 12: Forward characteristics of reverse diode



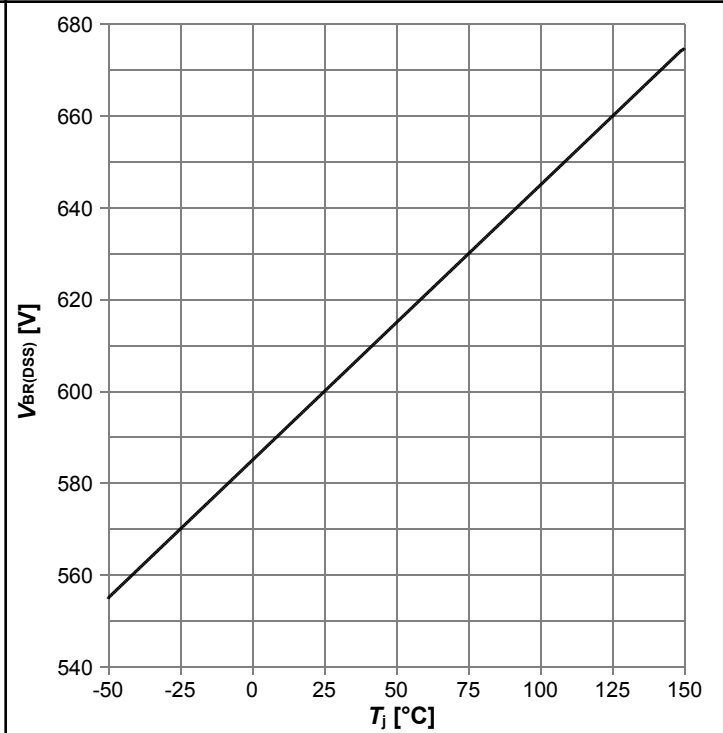
$I_F = f(V_{SD})$ ;  $V_{GS} = 12 V$ ; parameter:  $T_j$

Diagram 13: Avalanche energy



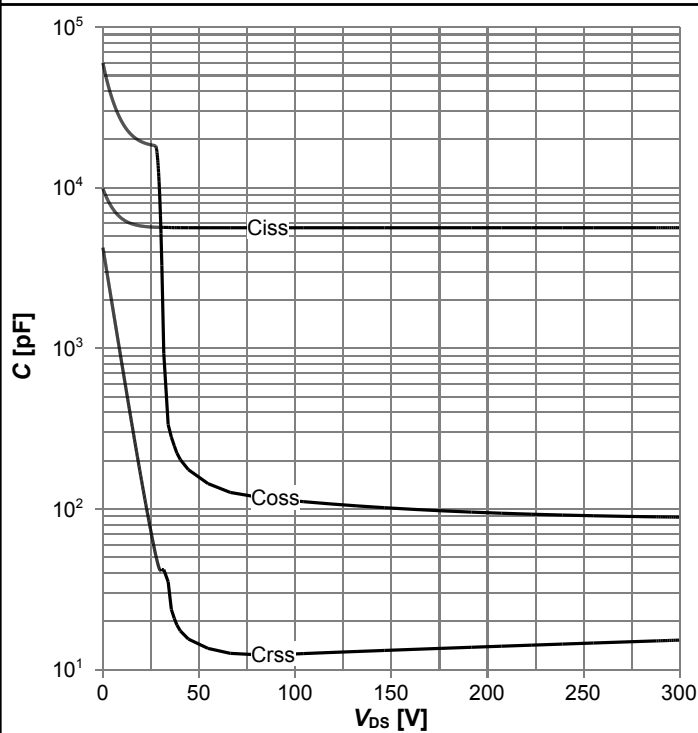
$E_{AS}=f(T_j)$ ;  $I_D=3.8$  A;  $V_{DD}=50$  V

Diagram 14: Drain-source breakdown voltage



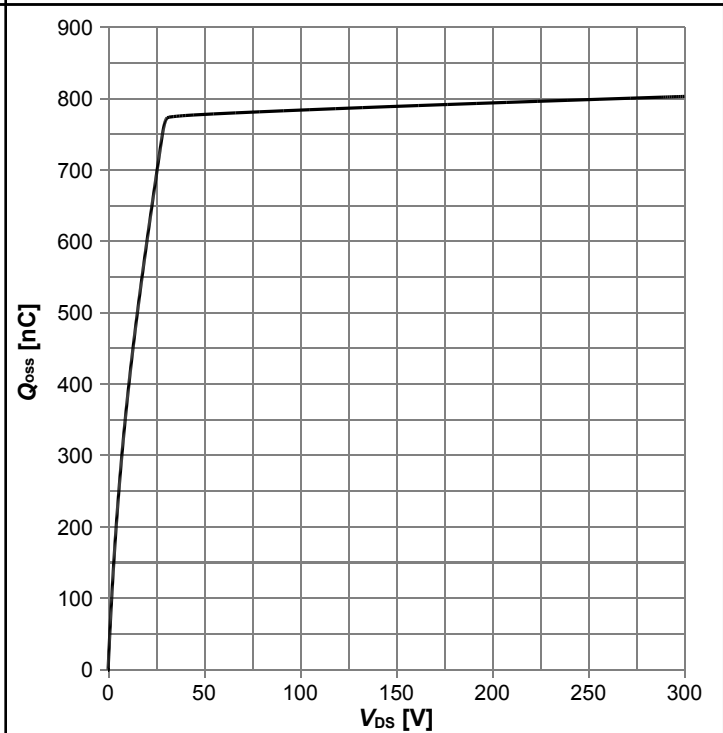
$V_{BR(DSS)}=f(T_j)$ ;  $I_D=1$  mA

Diagram 15: Typ. capacitances



$C=f(V_{DS})$ ;  $V_{GS}=0$  V;  $f=250$  kHz

Diagram 17: Typ. Qoss output charge



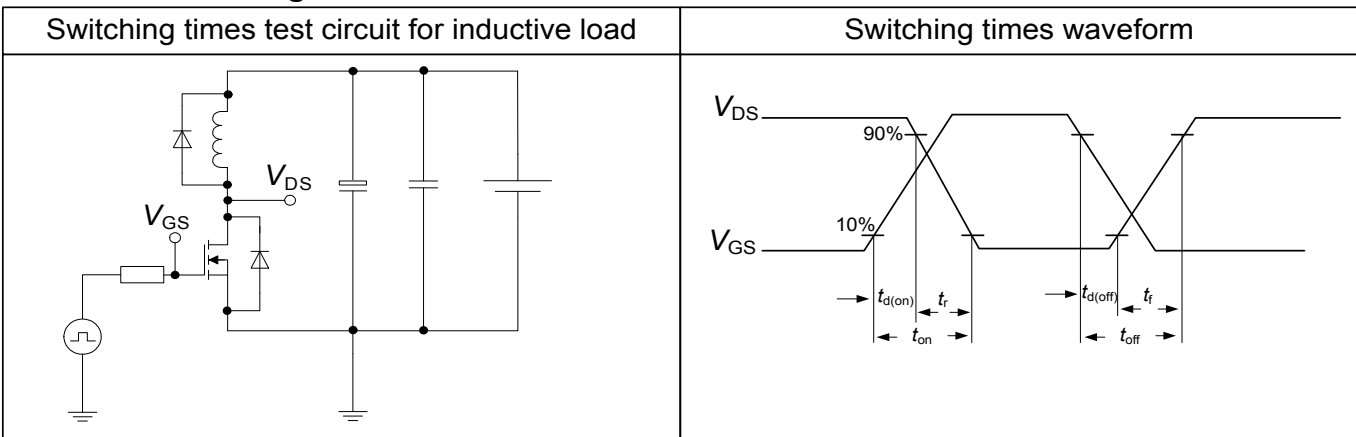
$Q_{oss}=f(V_{DS})$ ;  $V_{GS}=0$  V

## 5 Test Circuits

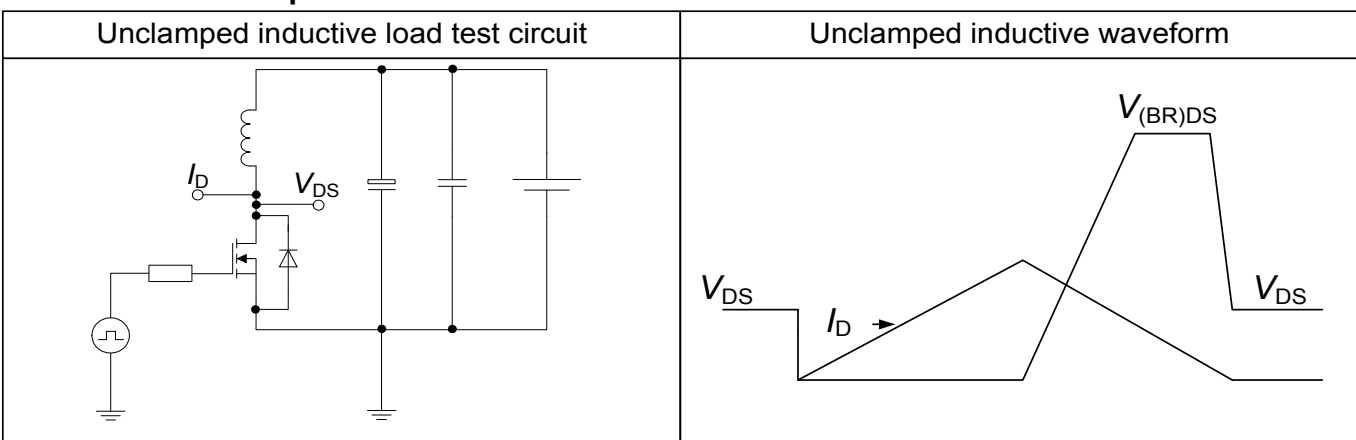
**Table 8 Diode characteristics**



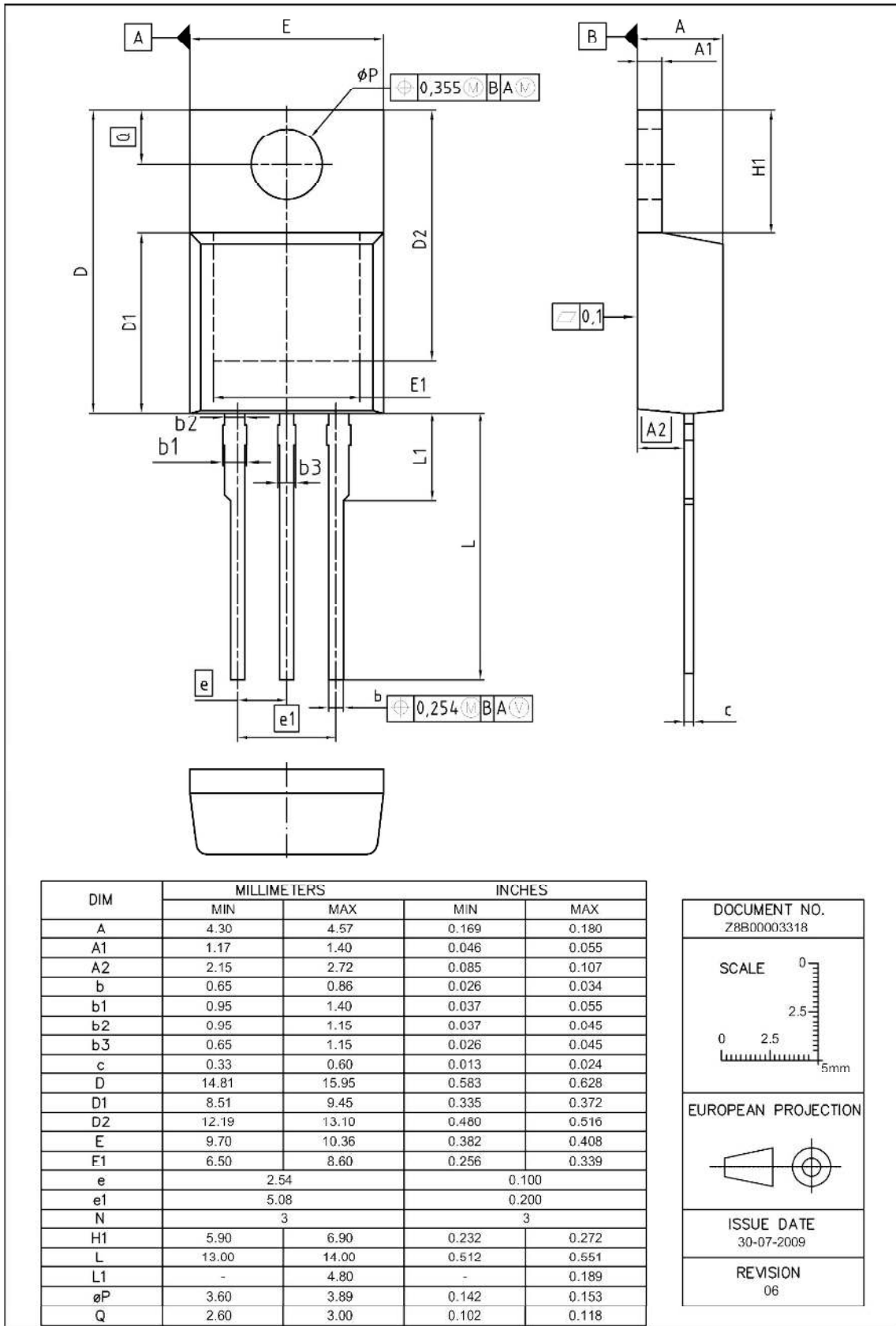
**Table 9 Switching times**



**Table 10 Unclamped inductive load**



**6 Package Outlines**



**Figure 1 Outline PG-TO220-3, dimensions in mm/inches**

## 7 Appendix A

### Table 11 Related Links

- IFX CoolMOS S7 Webpage: [www.infineon.com](http://www.infineon.com)
- IFX CoolMOS S7 application note: [www.infineon.com](http://www.infineon.com)
- IFX CoolMOS S7 simulation model: [www.infineon.com](http://www.infineon.com)
- IFX Design tools: [www.infineon.com](http://www.infineon.com)

## Revision History

IPP60R022S7

**Revision: 2021-10-25, Rev. 2.1**

Previous Revision

Revision	Date	Subjects (major changes since last revision)
2.0	2019-05-07	Release of final version
2.1	2021-10-25	Change of wording regarding breakdown voltage / cosmic ray

### Trademarks

All referenced product or service names and trademarks are the property of their respective owners.

### We Listen to Your Comments

Any information within this document that you feel is wrong, unclear or missing at all? Your feedback will help us to continuously improve the quality of this document. Please send your proposal (including a reference to this document) to:

**erratum@infineon.com**

### Published by

**Infineon Technologies AG**

**81726 München, Germany**

**© 2021 Infineon Technologies AG**

**All Rights Reserved.**

### Legal Disclaimer

The information given in this document shall in no event be regarded as a guarantee of conditions or characteristics ("Beschaffheitsgarantie").

With respect to any examples, hints or any typical values stated herein and/or any information regarding the application of the product, Infineon Technologies hereby disclaims any and all warranties and liabilities of any kind, including without limitation warranties of non-infringement of intellectual property rights of any third party.

In addition, any information given in this document is subject to customer's compliance with its obligations stated in this document and any applicable legal requirements, norms and standards concerning customer's products and any use of the product of Infineon Technologies in customer's applications.

The data contained in this document is exclusively intended for technically trained staff. It is the responsibility of customer's technical departments to evaluate the suitability of the product for the intended application and the completeness of the product information given in this document with respect to such application.

### Information

For further information on technology, delivery terms and conditions and prices please contact your nearest Infineon Technologies Office ([www.infineon.com](http://www.infineon.com)).

### Warnings

Due to technical requirements, components may contain dangerous substances. For information on the types in question, please contact the nearest Infineon Technologies Office.

The Infineon Technologies component described in this Data Sheet may be used in life-support devices or systems and/or automotive, aviation and aerospace applications or systems only with the express written approval of Infineon Technologies, if a failure of such components can reasonably be expected to cause the failure of that life-support, automotive, aviation and aerospace device or system or to affect the safety or effectiveness of that device or system. Life support devices or systems are intended to be implanted in the human body or to support and/or maintain and sustain and/or protect human life. If they fail, it is reasonable to assume that the health of the user or other persons may be endangered.