



MAX14548E Evaluation Kit

General Description

The MAX14548E evaluation kit (EV kit) provides a proven design to evaluate the MAX14548E 16-channel, bidirectional level translator. The MAX14548E translates between VL and VCC logic levels for data rates up to 100Mbps (50MHz).

The EV kit PCB comes with a MAX14548EEWL+ 40-bump WLP installed. Contact the factory for free samples of the pin-compatible MAX14548AEEWL+.

Features

- ◆ Powered by USB
- ◆ On-Board Clock Generator Capable of 33MHz
- ◆ Accessible Headers to All 16 Input/Output (I/O) Channels
- ◆ Proven PCB Layout
- ◆ Fully Assembled and Tested

Ordering Information

PART	TYPE
MAX14548EEVKIT+	EV Kit

+Denotes lead(Pb)-free and RoHS compliant.

Component List

DESIGNATION	QTY	DESCRIPTION
C1, C2	2	1 μ F \pm 10%, 6.3V X5R ceramic capacitors (0402) TDK C1005X5R0J105K
C3, C4, C11, C12	4	0.1 μ F \pm 10%, 16V X7R ceramic capacitors (0402) Murata GRM155R71C104K
C5, C6, C8, C9, C14	5	1 μ F \pm 10%, 16V X5R ceramic capacitors (0603) TDK C1608X5R1 C105K
C7, C10, C13	3	0.01 μ F \pm 10%, 16V X7R ceramic capacitors (0603) Murata GRM188R71C03K
D1	1	Green LED (0603)
H1, H2	2	32-pin headers (2 x 16)
JU1–JU7	7	3-pin headers
JU8, JU9	2	2-pin headers
P1	1	USB type-B, right-angle male receptacle
R1–R8, R17–R24, R33–R40, R49–R56, R65, R66	34	0 Ω \pm 5% resistors (0402)

DESIGNATION	QTY	DESCRIPTION
R9–R16, R25–R32, R41–R48, R57–R64	0	Not installed, resistors (0402)
R67	1	470 Ω \pm 5% resistor (0603)
U1	1	16-channel level translator (40 WLP) Maxim MAX14548EEWL+
U2	1	1.8V LDO (5 SC70) Maxim MAX8510EXK18+
U3	1	3V LDO (5 SC70) Maxim MAX8510EXK30+
U4	1	33MHz oscillator (8 μ MAX [®]) Maxim DS1091LUA-33+
U5	1	Dual inverter (6 SC70) Fairchild NC7WZ04P6X
—	1	USB type A-to-B cable, 6ft
—	9	Shunts
—	1	PCB: MAX14548E EVALUATION KIT+

μ MAX is a registered trademark of Maxim Integrated Products, Inc.



MAX14548E Evaluation Kit

Component Suppliers

SUPPLIER	PHONE	WEBSITE
Fairchild Semiconductor	888-522-5372	www.fairchildsemi.com
Murata Electronics North America, Inc.	770-436-1300	www.murata-northamerica.com
TDK Corp.	847-803-6100	www.component.tdk.com

Note: Indicate that you are using the MAX14548E when contacting these component suppliers.

Quick Start

Recommended Equipment

- MAX14548E EV kit (USB cable included)
- User-supplied PC with spare USB port
- 2-channel oscilloscopes (i.e., Tektronix TDS3012)

Procedure

The EV kit is fully assembled and tested. Follow the steps below to verify the board operation:

- 1) Verify that all jumpers are in their default positions, as shown in Table 1.
- 2) Connect the USB cable to the USB connector (P1) on the EV kit.
- 3) Connect the first channel of the oscilloscope to H1-1, which is the 1.8V logic-level 33MHz signal input.
- 4) Connect the second channel of the oscilloscope to H2-2, which is the 3V logic-level 33MHz signal output.
- 5) Using the oscilloscope, verify that the 1.8V logic-level 33MHz I/O_VL1 signal is translated to the 3V logic level at the H2-2 header.

Detailed Description of Hardware

The MAX14548E EV kit provides a proven design to evaluate the MAX14548E 16-channel, bidirectional level translator. The device translates between VL and VCC logic levels for data rates up to 50MHz.

Shutdown Mode

The device enters shutdown mode by moving the shunt on jumper JU1 to the 2-3 position. Otherwise, leave the shunt at the 1-2 position for normal operation.

Clock Generator

The EV kit includes the convenience of an on-board clock generator (U4) capable of producing 33MHz signals on the I/O_VL1 and I/O_VCC1 inputs.

When translating from VL to VCC, move the shunt on jumper JU5 to the 1-2 position, place a shunt on jumper JU9, and remove the shunt from jumper JU8. To go from VCC to VL, move JU5 to the 2-3 position, remove the shunt from JU9, and place a shunt on JU8.

Programmable Maximum Frequency

The maximum input frequency can be set for the device using jumper JU4. When JU4 is in the 1-2 position, the maximum input frequency is set to 40Mbps (20MHz). Move the shunt on JU4 to the 2-3 position for 100Mbps (50MHz).

Applying User Signals to I/O_VL_ and I/O_VCC_

The EV kit allows user-supplied input signals to be applied to the H1 and H2 headers. Remove shunts from jumpers JU8 and JU9 and apply the input signals to the appropriate pins on headers H1 and H2 (see Tables 2 and 3).

User-Supplied VDD_EXT, VL, VCC, and VCLK

The EV kit is powered completely from the USB when jumper JU6 is in the 1-2 position. Move JU6 to the 2-3 position and a user-supplied power supply can be applied to the VDD_EXT and GND pads.

Users can supply their own VL and VCC voltages by moving jumpers JU2 and JU3 to the 2-3 position. Apply a voltage from 1.1V to 3.6V to the VL and GND pads and 1.7V to 3.6V to the VCC and GND pads.

When jumper JU7 is in the 1-2 position, the clock generator is powered from VCC. To use a separate supply for the clock generator, place the shunt on JU7 in the 2-3 position and apply a 3V to 3.6V supply between the VCLK and GND pads.

MAX14548E Evaluation Kit

Evaluates: MAX14548E/MAX14548AE

Table 1. Jumper Description (JU1–JU9)

JUMPER	SHUNT POSITION	DESCRIPTION
JU1	1-2*	Enables the device for normal operation
	2-3	Sets the device to shutdown mode
JU2	1-2*	Sets the device VL logic level using the on-board 1.8V LDO
	2-3	Sets the device VL logic level using an external supply
JU3	1-2*	Sets the device VCC logic level using the on-board 3V LDO
	2-3	Sets the device VCC logic level using an external supply
JU4	1-2	Sets the device maximum bit rate to 40Mbps (20MHz)
	2-3*	Sets the device maximum bit rate to 100Mbps (50MHz)
JU5	1-2*	Enables the inverter (U5) and sets the inverter's output to VL logic level
	2-3	Enables the inverter (U5) and sets the inverter's output to VCC logic level
JU6	1-2*	Powers the EV kit using the USB supply
	2-3	Powers the EV kit using an external supply
JU7	1-2*	Powers the clock generator using the VCC supply of the device
	2-3	Powers the clock generator using an external supply
JU8	Open*	Disconnects the clock generator signal from the I/O_VCC1 pin of the device
	1-2	Connects the clock generator signal to the I/O_VCC1 pin of the device
JU9	Open	Disconnects the clock generator signal from the I/O_VL1 pin of the device
	1-2*	Connects the clock generator signal to the I/O_VL1 pin of the device

*Default position.

Table 2. H1 Header Description (I/O_VL_)

DESIGNATION	SIGNAL
H1-1	I/O_VL1
H1-3	I/O_VL2
H1-5	I/O_VL3
H1-7	I/O_VL4
H1-9	I/O_VL5
H1-11	I/O_VL6
H1-13	I/O_VL7
H1-15	I/O_VL8
H1-17	I/O_VL9
H1-19	I/O_VL10
H1-21	I/O_VL11
H1-23	I/O_VL12
H1-25	I/O_VL13
H1-27	I/O_VL14
H1-29	I/O_VL15
H1-31	I/O_VL16

Table 3. H2 Header Description (I/O_VCC_)

DESIGNATION	SIGNAL
H2-2	I/O_VCC1
H2-4	I/O_VCC2
H2-6	I/O_VCC3
H2-8	I/O_VCC4
H2-10	I/O_VCC5
H2-12	I/O_VCC6
H2-14	I/O_VCC7
H2-16	I/O_VCC8
H2-18	I/O_VCC9
H2-20	I/O_VCC10
H2-22	I/O_VCC11
H2-24	I/O_VCC12
H2-26	I/O_VCC13
H2-28	I/O_VCC14
H2-30	I/O_VCC15
H2-32	I/O_VCC16

Evaluates: MAX14548E/MAX14548AE

MAX14548E Evaluation Kit

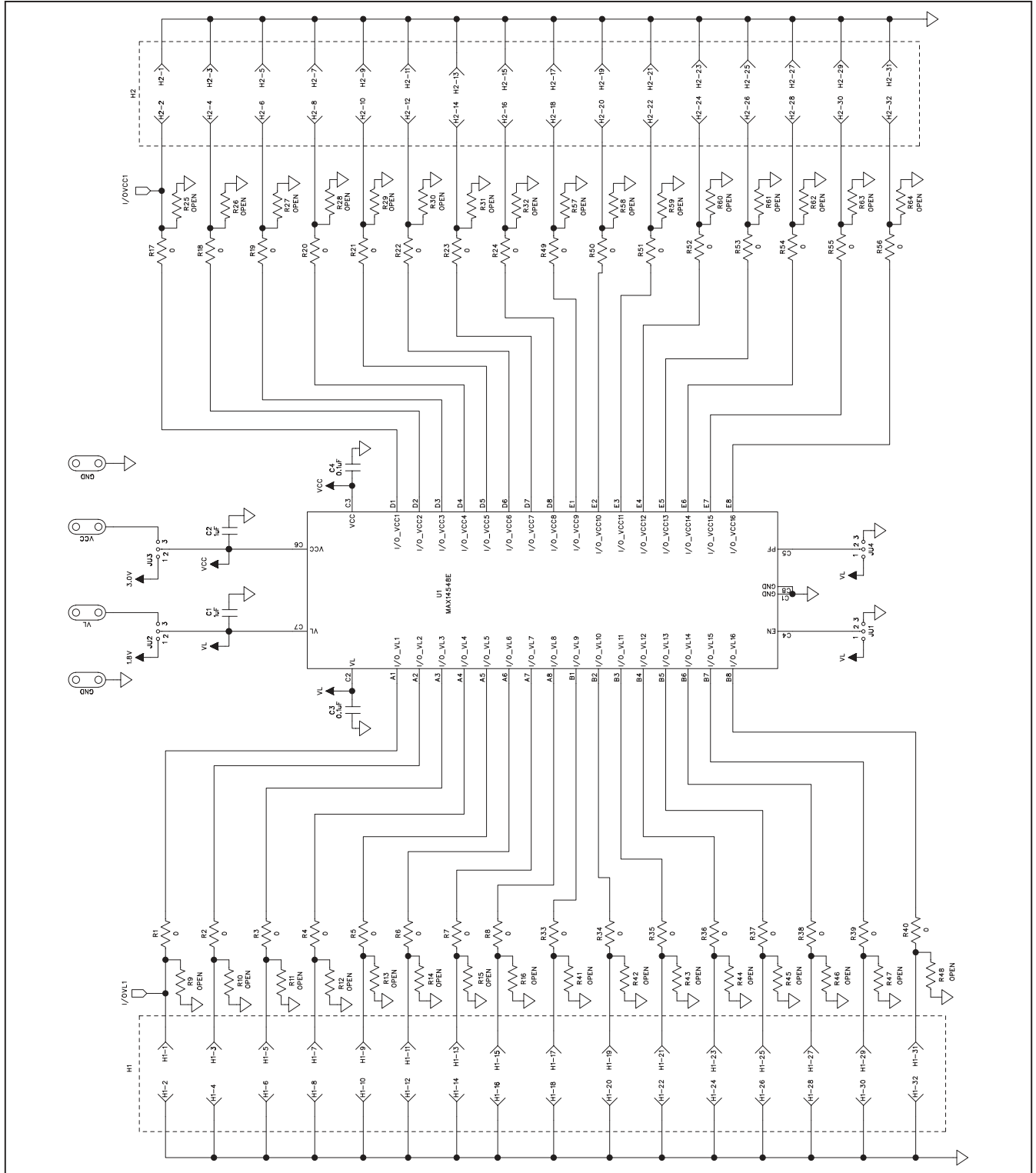

Figure 1a. MAX14548E EV Kit Schematic (Sheet 1 of 2)

MAX14548E Evaluation Kit

Evaluates: MAX14548E/MAX14548AE

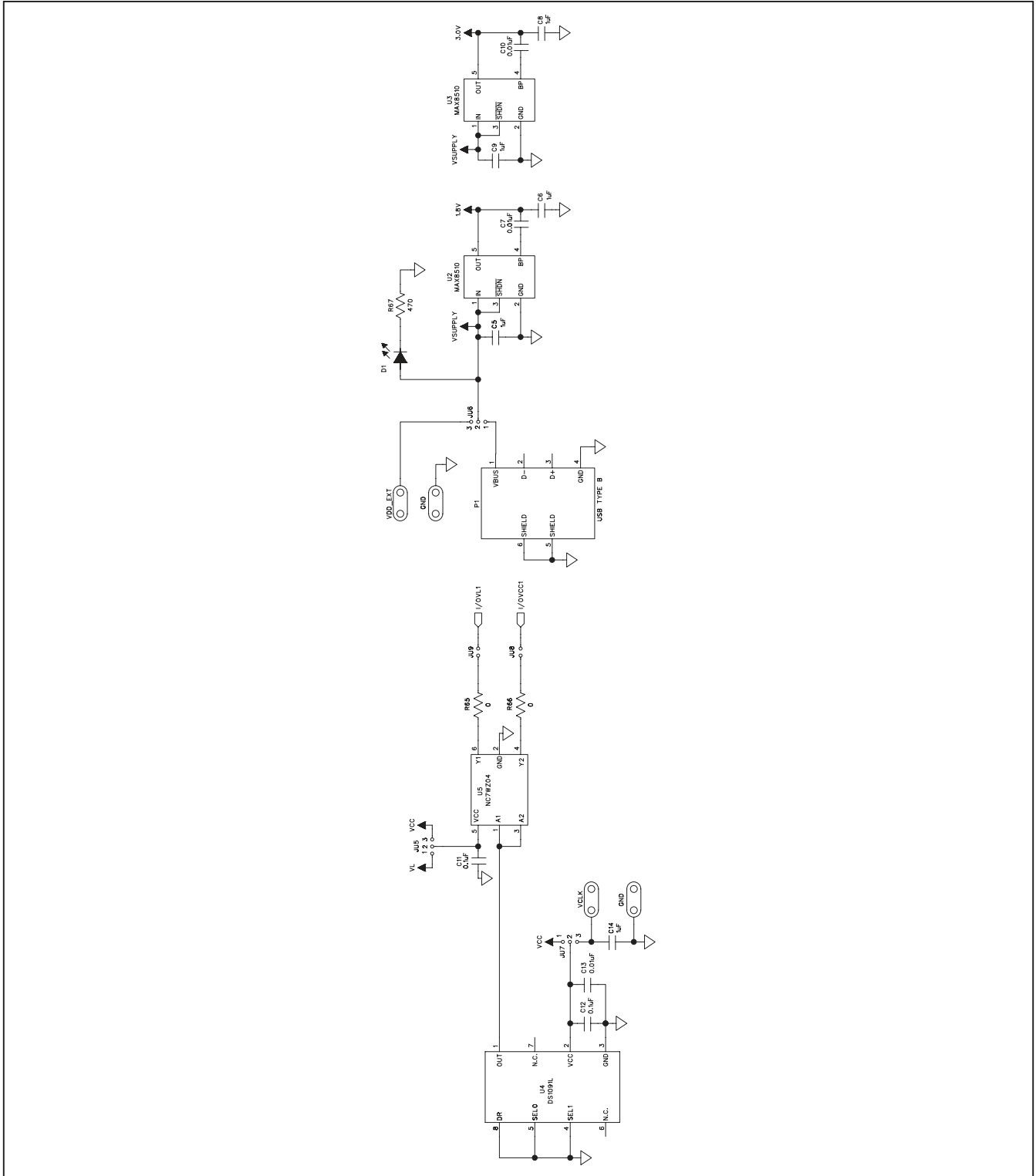

Figure 1b. MAX14548E EV Kit Schematic (Sheet 2 of 2)

MAX14548E Evaluation Kit

Evaluates: MAX14548E/MAX14548AE

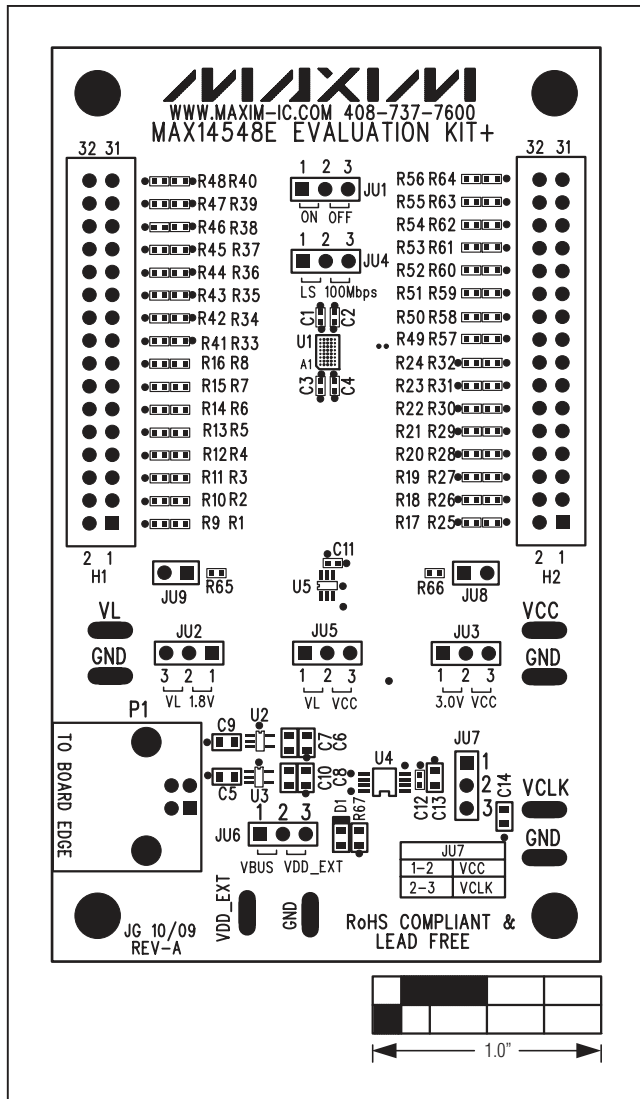

Figure 2. MAX14548E EV Kit Component Placement Guide—Component Side

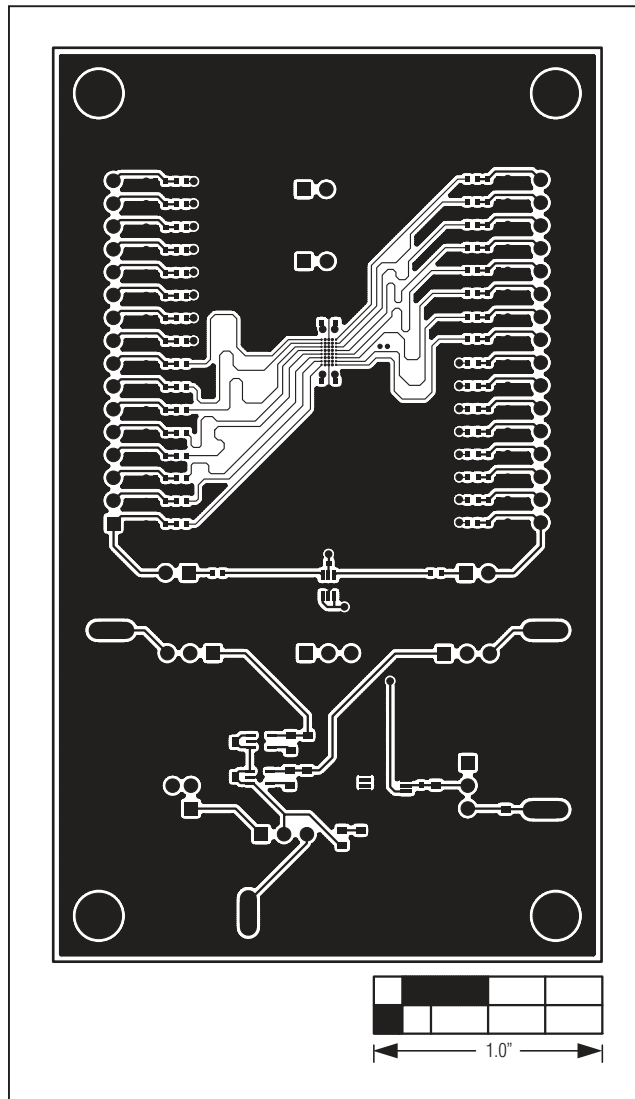

Figure 3. MAX14548E EV Kit PCB Layout—Component Side

MAX14548E Evaluation Kit

Evaluates: MAX14548E/MAX14548AE

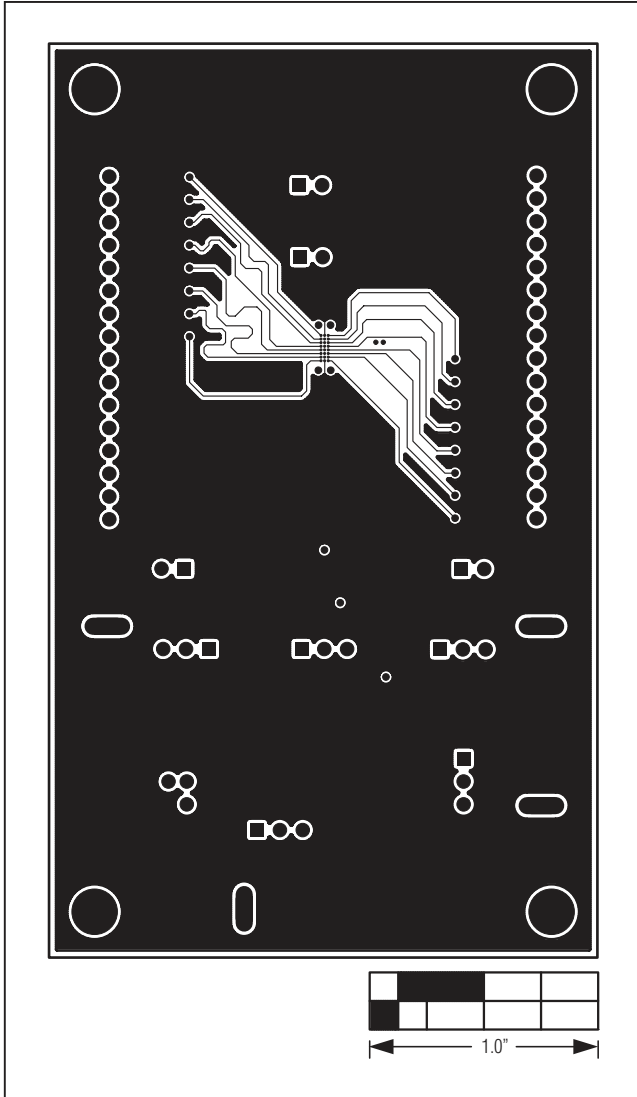

Figure 4. MAX14548E EV Kit PCB Layout—Inner Layer 2

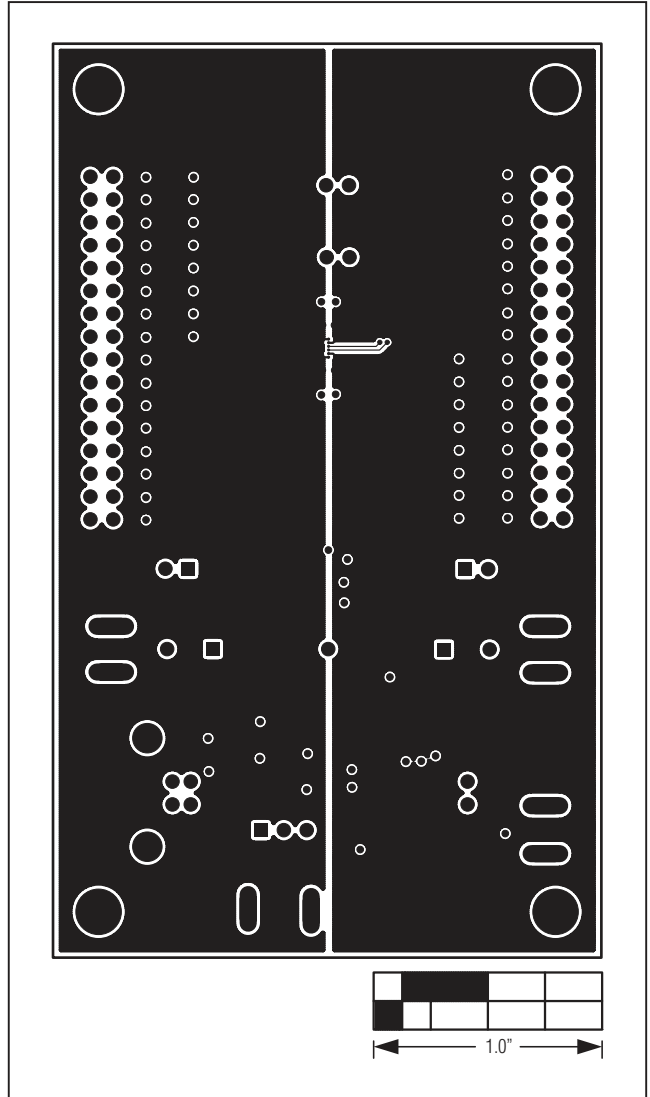

Figure 5. MAX14548E EV Kit PCB Layout—Inner Layer 3

MAX14548E Evaluation Kit

Evaluates: MAX14548E/MAX14548AE

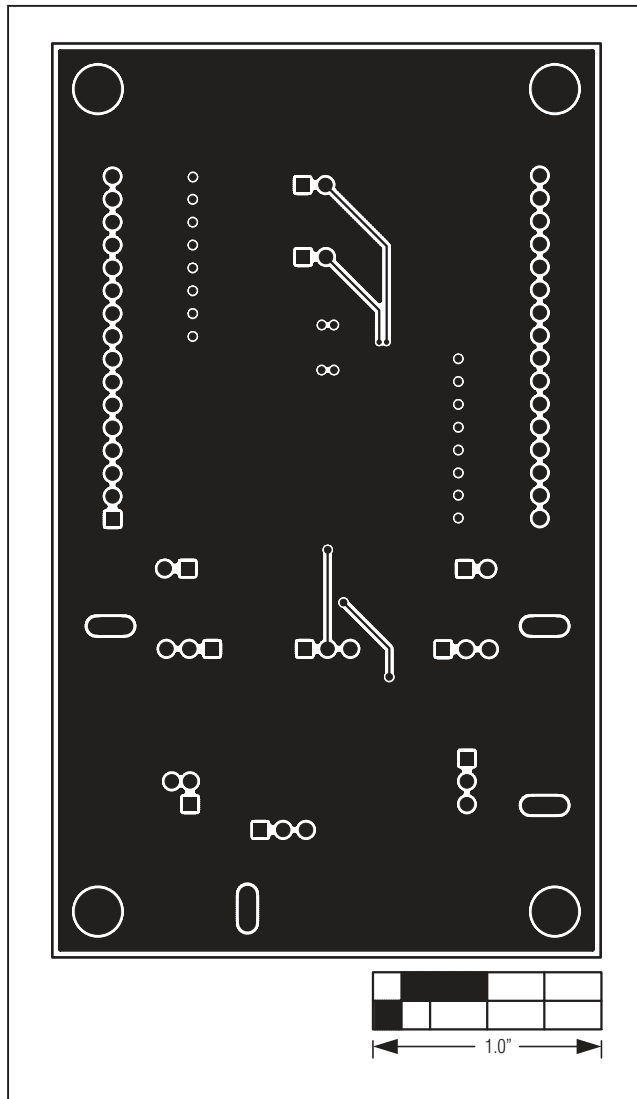

Figure 6. MAX14548E EV Kit PCB Layout—Solder Side

MAX14548E Evaluation Kit

Revision History

REVISION NUMBER	REVISION DATE	DESCRIPTION	PAGES CHANGED
0	6/10	Initial release	—

Evaluates: MAX14548E/MAX14548AE

Maxim cannot assume responsibility for use of any circuitry other than circuitry entirely embodied in a Maxim product. No circuit patent licenses are implied. Maxim reserves the right to change the circuitry and specifications without notice at any time.

Maxim Integrated Products, 120 San Gabriel Drive, Sunnyvale, CA 94086 408-737-7600 _____ 9