

**Order Number
200218-6500**

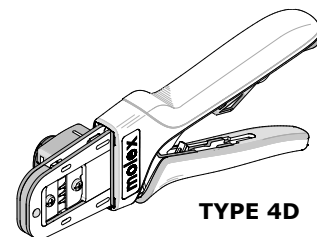

Application Tooling Specification



TYPE 4D

FEATURES

- A full-cycle ratcheting hand tool ensures complete crimps
- Ergonomic soft grip handles for comfortable crimping
- A precision user-friendly terminal locator holds terminals in the proper crimping position
- Right- or left-handed operation
- Tooling can be installed in the 63816-1920 Power Crimp Head, which is installed into the 63816-0270 (110 V) or 63816-0280 (220 V) Battery Powered Tools and the 63816-1900 Electric Crimp Machine
- This tool is IPC/WHMA-A-620 compliant, as indicated on page 2

SCOPE

Products: Nano-Fit Plug Crimp Terminals and 24-26 AWG wires

Terminal Series No.	Terminal Order No.	Wire		Insulation Diameter		Strip Length	
		Size	Wire Type	mm	In.	mm	In.
201447	201447-1100	24 AWG	UL1007	1.20-1.45	.047-.057	2.50-3.50	.098-.138
	201447-1200		UL1061	0.90-1.15	.035-.045	2.50-3.50	.098-.138
	201447-1300						
	201447-1400	26 AWG	UL1007	1.20-1.45	.047-.057	2.50-3.50	.098-.138
	201447-1600		UL1061	0.90-1.15	.035-.045	2.50-3.50	.098-.138
	201447-1800						

DEFINITION OF TERMS

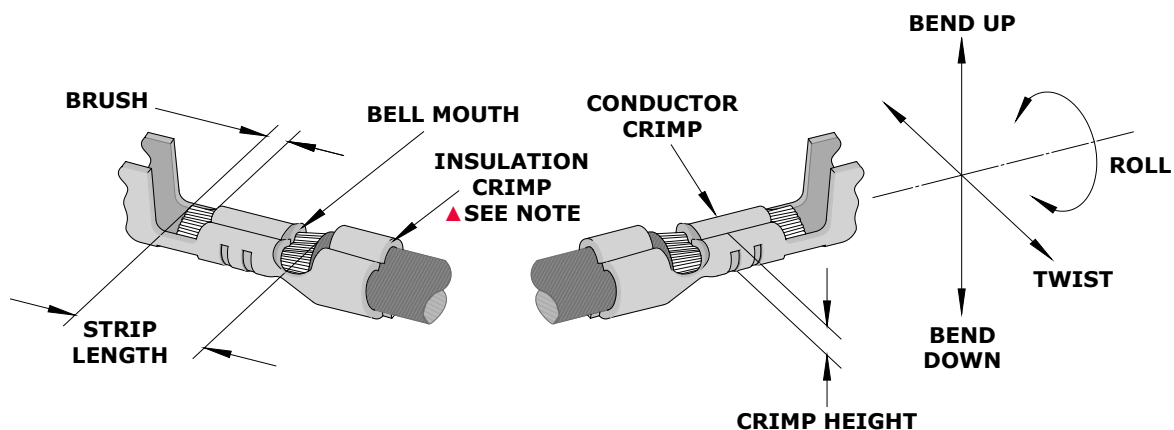

▲ Insulation Crimp Note

Due to the terminal’s insulation grip design or insulation diameter range, this tool uses overlap form geometry in the insulation punch. This produces an overlap insulation crimp (A-620-compliant). Although the insulation punch profile may appear lopsided, this is a normal condition for this tool. See figure to the right. This tool uses the overlap form on crimp profiles A and B only.

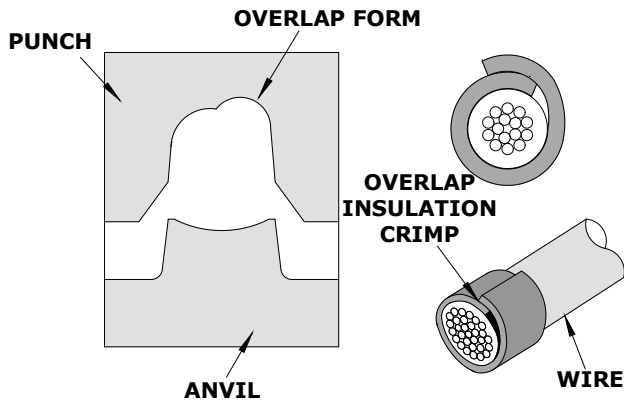

CONDITIONS

After crimping, the crimped profile should measure as follows:

Terminal Series No.	Wire		Conductor Crimp			
			Height		Width	
	Size	Type	mm	In.	mm	In.
201447	24 AWG	UL1007	0.70-0.75	.028-.030	1.10-1.20	.043-.047
		UL1061	0.70-0.75	.028-.030		
	26 AWG	UL1007	0.65-0.70	.026-.028		
		UL1061	0.65-0.70	.026-.028		

Terminal Series No.	Wire		◆ Insulation Crimp				Pull Force Minimum		Profile			
			Height (Ref.)		Width (Ref.)				A	B	C	D
	Size	Type	mm	In.	mm	In.	N	Lb.				
201447	24 AWG	UL1007	1.55-1.75	.061-.069	1.60-1.80	.063-.071	22.3	5.0	X			
		UL1061	1.45-1.65	.057-.065	1.45-1.65	.057-.065	22.3	5.0		X		
	26 AWG	UL1007	1.50-1.65	.059-.065	1.55-1.80	.061-.071	13.4	3.0			X	
		UL1061	1.40-1.60	.055-.063	1.40-1.60	.055-.063	13.4	3.0				X

◆ To achieve IPC/WHMA-A-620 crimps, the following overall wire insulation diameter ranges are recommended:

Profile A: 24 AWG UL1061: 1.11–1.20mm (.044–.047")

Profile B: 26 AWG UL1061: 0.97–1.12mm (.038–.044")

Profile C: 24 AWG UL1007: 1.30–1.45mm (.051–.057")

Profile D: 26 AWG UL1007: 1.20–1.30mm (.047–.051")

Crimp attribute specifications are as follows:

Terminal Series No.	Wire Size	Bell Mouth		Brush		Bend Up	Bend Down	Twist	Roll
	AWG	mm	In.	mm	In.				
201447	24	0.15-0.30	.006-.012	1.00	.039	3° max	3° max	4° max	8° max
	26								

Tool Qualification Notes

- (Ref) means that the dimension provided is approximate because of the wide range of wires, conductor stranding, insulation diameter and insulation hardness.
- An occasional conductor crimp height measurement should be performed. It must lie between the minimum and maximum crimp height specification. Refer to Molex Quality Crimping Handbook 63800-0029 for additional information on crimping and crimp testing.
- In addition, an occasional pull force test may be performed. It must exceed the minimum pull force specification. Pull force should be measured with no influence from the insulation crimp. To ensure this, strip the wire long enough so the terminal insulation grips do not contact the wire insulation.

Notes

- This tool should only be used for the terminals and wire gauges specified on this sheet.

Hand Crimp Tool for Nano-Fit Plug Crimp Terminals

2. Variations in tools, terminals, wire stranding and insulation types may affect crimp height.
3. This tool is intended for AWG conductor sizes. It may not give good insulation crimp support for insulation sizes outside of the specified range.
4. Molex does not repair hand tools. See warranty on page 6. The replacement parts listed are the only parts available for repair. If the handles or crimp tooling become damaged or worn, a new tool must be purchased.



CAUTION: Crimp only the Molex terminals listed in the scope for this tool. Do not crimp hardened objects as damage can occur to the tool frame or crimp dies.

OPERATION

Open the tool by squeezing the handles together. At the end of the closing stroke, the ratchet mechanism will release the handles and the hand tool will spring open. See Figure 1.

Crimping Terminals

1. Select the desired terminal listed from the preceding charts. Then, install it in the proper locator. See Locator Replacement section on page 4.
2. Make sure the center of the locator is in the down position. With the locator attached, push the locator button on the back of the hand tool to bring the locator forward through the tooling. See Figure 2.
3. While holding in the locator button, load the terminal into the proper nest opening in the locator based on the wire gauge or terminal type markings on the hand tooling. See Figure 3.

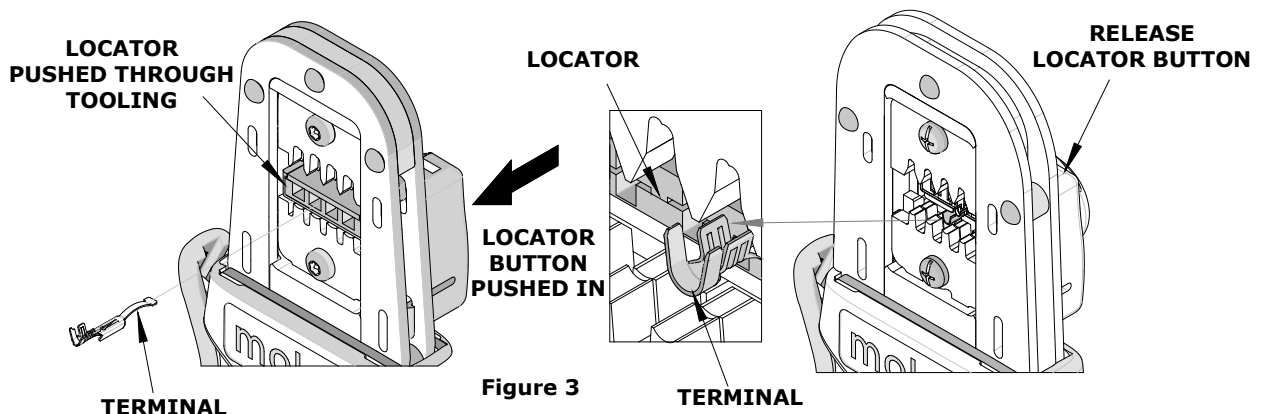
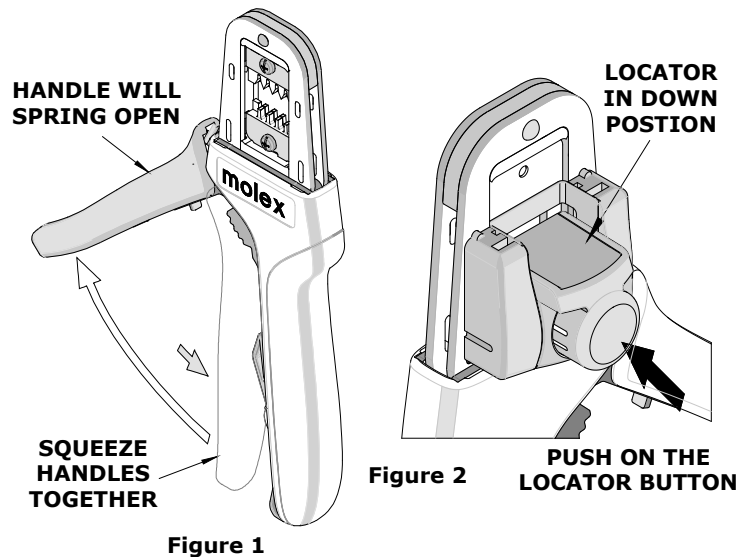

Hand Crimp Tool for Nano-Fit Plug Crimp Terminals

4. Release the locator button, allowing the locator to return to the crimping position.
5. Close the tool handle until the first ratchet position engages. See Figure 4.
6. Insert the properly stripped wire through the terminal and against the wire stop. See Figure 5.

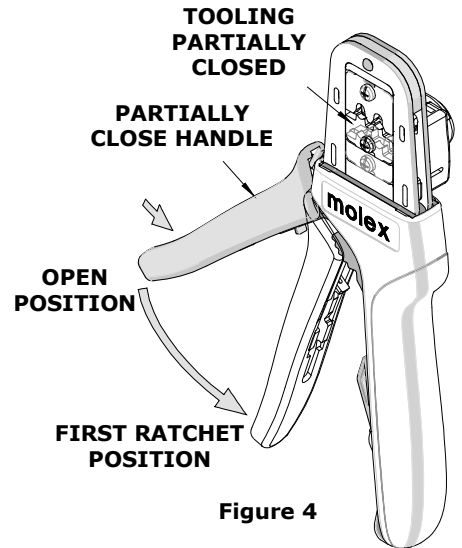
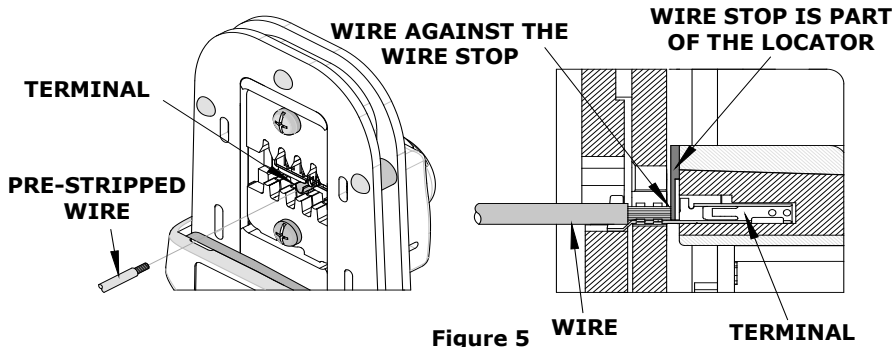

7. Crimp the terminal by squeezing the tool handles until the ratchet mechanism cycle has been completed. Release the handles to open the jaws.

Note: The tamper-proof ratchet action will not release the tool until it has been fully closed.

8. Remove the crimped terminal from the terminal locator by pulling on the wire.
9. Visually inspect the crimped terminal for proper crimp location.
10. On some large O.D. wires, it may not be possible to insert the wire with the tool partially closed. Those wires should be inserted with the hand tool in the open position. Insert the wire above the terminal in the punch and against the wire stop, and then close the tool. See Figure 6.

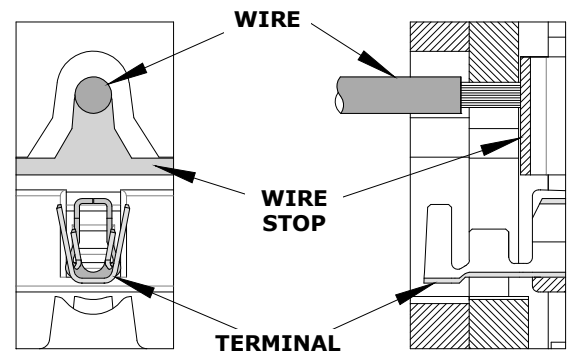

Locator Replacement

See the parts list on the last page of this document for the proper locator order number. Follow the steps below to replace the locator:

1. Open the hand crimp tool.
2. Squeeze gently on the lower area shown in Figure 7A with your thumb and index finger. The lower tabs of the locator should disengage from the hand tool.
3. Lift and pull away from the hand tool. The top locator hooks should slip out of the top slots easily. See Figure 7A.
4. To reinstall the new locator, make sure the hand tool is in the open position.
5. Press the center of the locator down as far as it will go as shown in Figure 7B.
6. Holding onto the lower part of the locator with your thumb and index finger, insert the locator's top hooks into the hand tool's top slots.

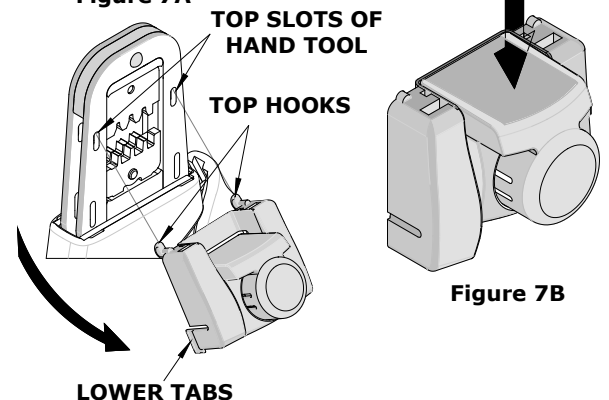
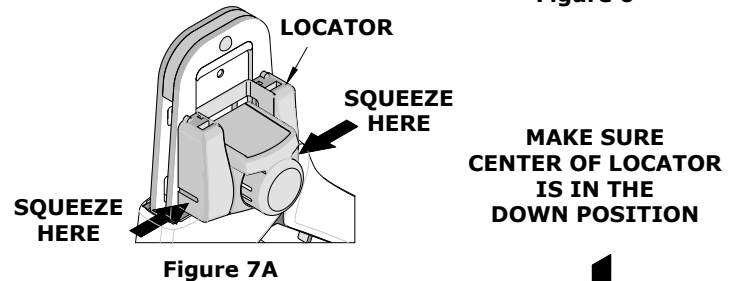

Hand Crimp Tool for Nano-Fit Plug Crimp Terminals

7. Rotate the locator down and press the lower tabs into the two bottom slots of the hand tool. To secure the locator into place, the lower tabs must snap into place on the hand tool frame.

Right- or Left-Handed Operation

This hand tool has an added feature that can be converted from a right-handed application to a left-handed application. It is necessary to reverse the tooling along with the locator if using the left-handed application. Follow the steps below:

1. The locator must be removed before reversing the tooling.
2. Remove the M3 BHCS, which is holding the upper tooling.
3. Flip the upper tooling to the opposite side and replace the M3 BHCS. Make sure the small markings on the front and back of the hand tool frame match up and are on the outside of the hand tool frame. See Figures 8 and 9.
4. Do the same thing with the lower tooling and tighten the M3 screws. Be sure the small markings line up.
5. Reinstall the locator by following the instructions in the locator replacement section.

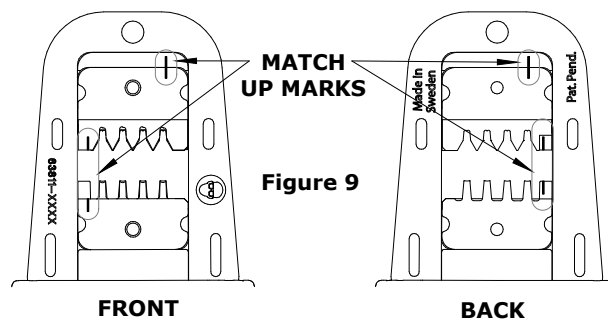
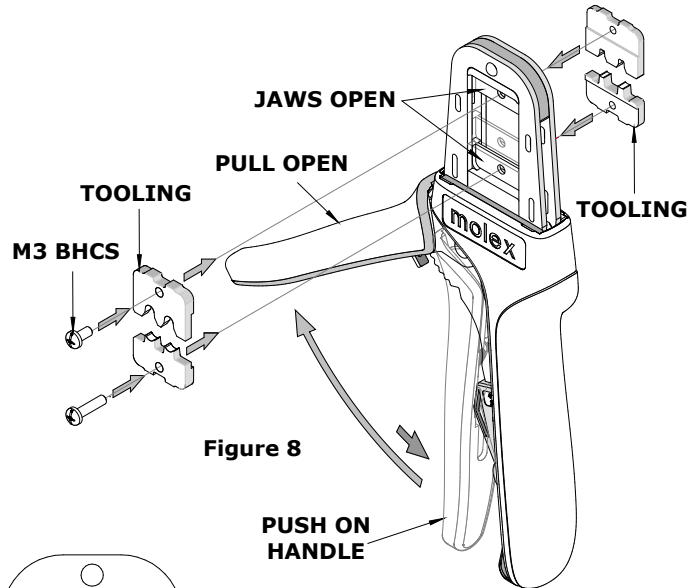

MAINTENANCE

It is recommended that each operator of the tool be made aware of and responsible for the following maintenance steps:

1. Remove dust, moisture and other contaminants with a clean brush or a soft, lint-free cloth.
2. Do not use any abrasive materials that could damage the tool.
3. Make certain all pins, pivot points and bearing surfaces are protected with a thin coat of high-quality machine oil. Do not oil excessively. The tool was engineered for durability, but like any other equipment, it needs cleaning and lubrication for a maximum service life of trouble-free crimping. Light oil (such as 30 weight automotive oil) used at the oil points every 5,000 crimps or 3 months will significantly enhance the tool life. See Figure 10.
4. Wipe excess oil from the hand tool, particularly from the crimping area. Oil transferred from the crimping area onto certain terminations may affect the electrical characteristics of an application.
5. When the tool is not in use, keep the handles closed to prevent objects from becoming lodged in the crimping dies, and store the tool in a clean, dry area.

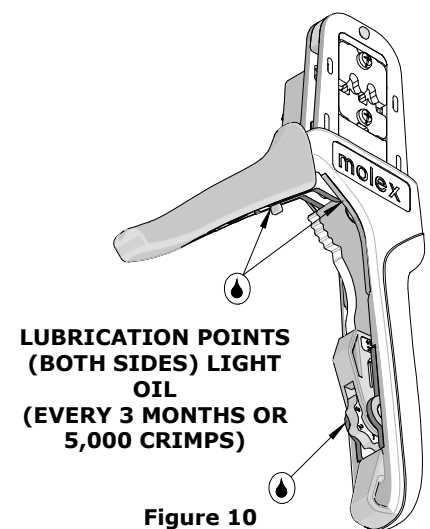

Miscrimps or Jams

Should this tool ever become stuck or jammed in a partially closed position, **do not force the handles open or closed**. The tool will open easily by pressing up on the ratchet release lever in the movable handle. See Figure 11.

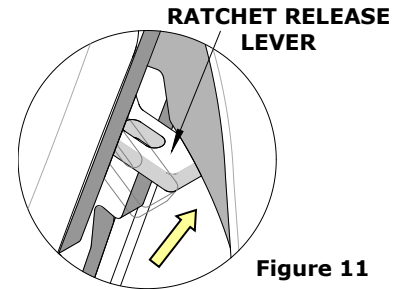

Figure 11

How to Adjust Tool Preload (See Figure 12)

This hand tool is factory preset to 25-45 pounds preload. It may be necessary over the life of the tool to adjust tool handle preload force. Listed below are the steps required to adjust the crimping force of the hand tool to obtain proper crimp conditions:

1. Hold the hand tool in the palm of your hand as shown in Figure 12. Using your index finger, squeeze the link toward the top of the hand tool frame. This will release the preload adjustment wheel.
2. Rotate the setting wheel counterclockwise (CCW) to increase handle force. The numbers will display higher. To decrease handle force, rotate the setting wheel clockwise (CW).
3. Release the link to lock the setting wheel in place.
4. Check the crimp specifications or conduct a pull test after tool handle preload force is adjusted.

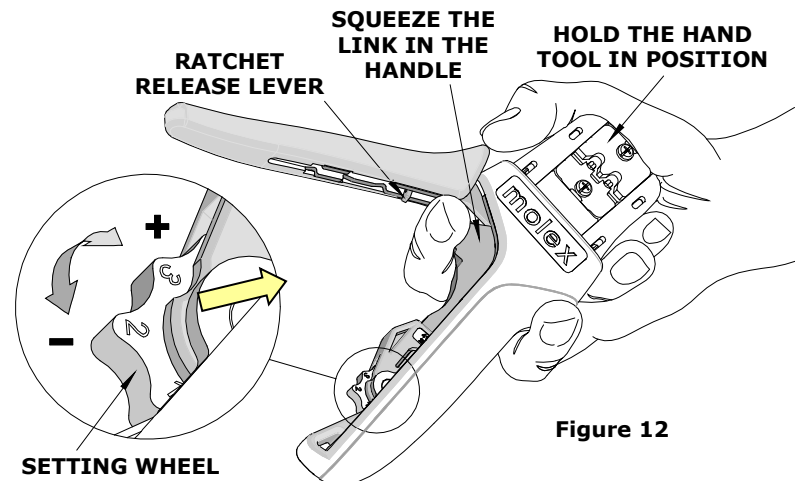

Figure 12

Warranty

This tool is for electrical terminal crimping purposes only. This tool is made of the best quality materials. All vital components are long life tested. All tools are warranted to be free of manufacturing defects for a period of 30 days. Should such a defect occur, Molex will repair or exchange the tool free of charge. This repair or exchange will not be applicable to altered, misused or damaged tools. This tool is designed for hand use only. Any clamping, fixturing or use of handle extensions voids this warranty.

CAUTION: Molex crimp specifications are valid only when used with Molex terminals and tooling.

CAUTIONS:

1. Manually powered hand tools are intended for low-volume use or field repair. This tool is **NOT** intended for production use. Repetitive use of this tool should be avoided.
2. Insulated rubber handles are not protection against electrical shock.
3. Wear eye protection at all times.
4. Use only the Molex terminals specified for crimping with this tool.

Certification

Molex does not certify or re-certify hand tools but rather supplies the following guidelines for customers to re-certify hand tools:

- This tool is qualified to pull force only. To re-certify, crimp a terminal to a wire that has been stripped 12.7mm (.50") long so there is no crimping of the insulation. Pull the terminal and wire at a rate no faster than 25mm (1.00") per minute. See the Molex website for the Quality Crimp Handbook for more information on pull testing.
- If the tool does not meet minimum pull force values, handle preload should be increased, and the pull test should be rerun. See How to Adjust Preload.
- When the hand tool is no longer capable of achieving minimum pull force, it should be taken out of service and replaced.

PARTS LIST

Item Number	Order Number	Description	Quantity
REF	200218-6500	Hand Crimp Tool	Figure 13
1	200218-6575	Locator Assembly	1
2	63810-0104	Spring, Return	1
3	63810-0105	Spring, Ratchet	1

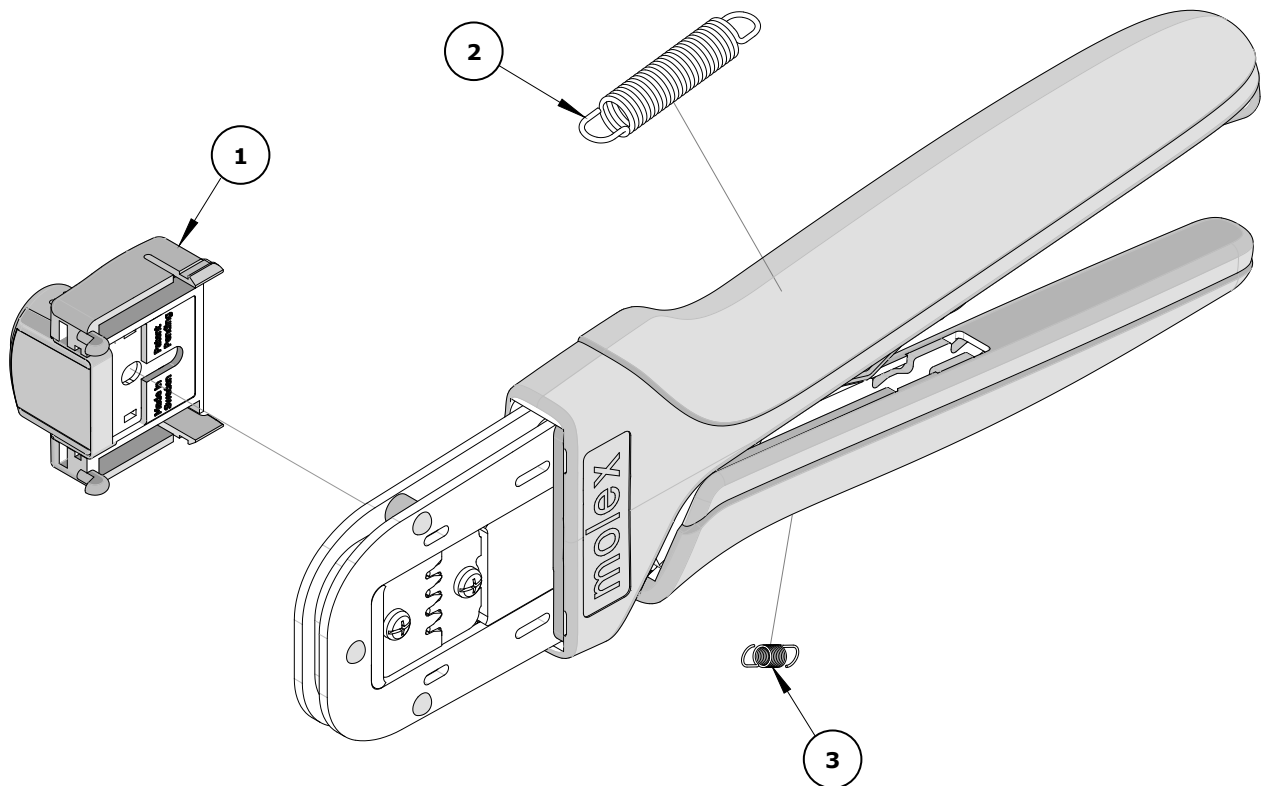

Figure 13

Application Tooling Support

E-Mail: toolingsupport@molex.com
Website: www.molex.com/applicationtooling

Molex is a registered trademark of Molex, LLC in the United States of America and may be registered in other countries; all other trademarks listed herein belong to their respective owners.