



AR0238: 1/2.7-Inch 2.1 Mp/Full HD Digital Image Sensor

General Description

ON Semiconductor's AR0238 is a 1/2.7-inch CMOS digital image sensor with an active-pixel array of 1928Hx1088V. It captures images in either linear or high dynamic range modes, with a rolling-shutter readout. It includes sophisticated camera functions such as in-pixel binning, windowing and both video and single frame modes. It is designed for both low light and high dynamic range scene performance. It is programmable through a simple two-wire serial interface. The AR0238 produces extraordinarily clear, sharp digital pictures, and its ability to capture both continuous video and single frames makes it the perfect choice for a wide range of applications, including surveillance and HD video.

Table 1. KEY PARAMETERS

Parameter		Typical Value
Optical format		1/2.7-inch (6.6 mm)
Active pixels		1928(H) x 1088(V) (16:9 mode)
Pixel size		3.0 μm x 3.0 μm
Color filter array		RGB Bayer, RGB-IR
Shutter type		Electronic rolling shutter and GRR
Input clock range		6 – 48 MHz
Output clock maximum		148.5 Mp/s (4-lane HiSPi) 74.25 Mp/s (Parallel)
Output	Serial	HiSPi 10-, or 12-bit
	Parallel	10-, or 12-bit
Frame rate	1080p	60 fps Linear HiSPi 30 fps Linear Parallel 30 fps Line Interleaved HiSPi 15 fps Line Interleaved Parallel
Responsivity		4.0 V/lux-sec
SNR _{MAX}		41 dB
Max Dynamic range		Up to 96 dB
Supply voltage	I/O	1.8 or 2.8 V
	Digital	1.8 V
	Analog	2.8 V
	HiSPi	0.3 V – 0.6 V (SLVS), 1.7 V – 1.9 V (HiVcm)
Power consumption (typical)		< 300mW Line interleaved 1080p30 <190mW 1080p30 Linear Mode
Operating temperature		-30°C to + 85°C Ambient
Package options		11.43x11.43 mm 48-pin mPLCC Recon Die

Features

- Superior Low-light Performance
- Latest 3.0 μm Pixel with ON Semiconductor DR-Pix™ Technology with Dual Conversion Gain
- Full HD Support at up to 1080P 60 fps for Superior Video Performance
- Linear or High Dynamic Range Capture
- Supports Line Interleaved T1/T2 readout to Enable HDR Processing in ISP Chip
- Support for External Mechanical Shutter
- On-chip Phase-locked Loop (PLL) Oscillator
- Integrated Position-based Color and Lens Shading Correction
- Slave Mode for Precise Frame-rate Control
- Stereo/3D Camera Support
- Statistics Engine
- Data Interfaces: Four-lane Serial High-speed Pixel Interface (HiSPi) Differential Signaling (SLVS and HiVCM), or Parallel
- Auto Black Level Calibration
- High-speed Configurable Context Switching
- Temperature Sensor

Applications

- Video Recording and Streaming
- 1080p60 (monitoring) Video Applications
- High Dynamic Range Imaging

AR0238

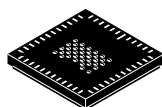

PLCC48 11.43x11.43 (HiSPi)
CASE 776AQ

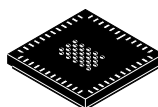

PLCC48 11.43x11.43 (Parallel)
CASE 776AS

Table 2. ORDERING INFORMATION

Part Number	Product Description	Orderable Product Attribute Description
AR0238CSSC12SHRA0-DR1	RGB Color, 12 Degree CRA, mPLCC, HiSPi	Dry Pack, No Protective film, Low MOQ
AR0238CSSC12SHRA0-DP1	RGB Color, 12 Degree CRA, mPLCC, HiSPi	Dry Pack, with Protective film, Low MOQ
AR0238CSSC12SHRA0-DR	RGB Color, 12 Degree CRA, mPLCC, HiSPi	Without protective film
AR0238CSSC12SHRA0-DP	RGB Color, 12 Degree CRA, mPLCC, HiSPi	With protective film
AR0238CSSC12SPRA0-DR	RGB Color, 12 Degree CRA, mPLCC, Parallel	Without Protective Film
AR0238CSSC12SPRA0-DR1	RGB Color, 12 Degree CRA, mPLCC, Parallel	Dry Pack, No Protective film, Low MOQ
AR0238CSSC12SUD20	RGB Color, 12 Degree CRA, Recon die	RGB Recon die
AR0238IRSH12SUD20	RGB-IR, 12 Degree CRA, Recon die	RGB-IR Recon die
AR0238CSSC12SHRAH3-GEVB	RGB Color, 12 Degree CRA, HiSPi	Evaluation Board

NOTE: See the ON Semiconductor Device Nomenclature document (TND310/D) for a full description of the naming convention used for image sensors. For reference documentation, including information on evaluation kits, please visit our web site at www.onsemi.com.

GENERAL DESCRIPTION

The ON Semiconductor AR0238 can be operated in its default mode or programmed for frame size, exposure, gain, and other parameters. The default mode output is a 1080p-resolution image at 60 frames per second (fps) through the HiSPi port. In linear mode, it outputs 12-bit or 10-bit A-Law compressed raw data, using the parallel or serial (HiSPi) output port. In high dynamic range mode, it outputs two exposure values that the ISP will combine into an HDR image. The device may be operated in video (master) mode or in single frame trigger mode.

FRAME_VALID and LINE_VALID signals are output on dedicated pins, along with a synchronized pixel clock in parallel mode.

The AR0238 includes additional features to allow application-specific tuning: windowing and offset, auto

black level correction, and on-board temperature sensor. Optional register information and histogram statistic information can be embedded in the first and last 2 lines of the image frame.

The AR0238 is designed to operate over a wide temperature range of -30°C to +85°C ambient.

FUNCTIONAL OVERVIEW

The AR0238 is a progressive-scan sensor that generates a stream of pixel data at a constant frame rate. It uses an on-chip, phase-locked loop (PLL) that can be optionally enabled to generate all internal clocks from a single master input clock running between 6 and 48 MHz. The maximum output pixel rate is 148.5 Mp/s, corresponding to a clock rate of 74.25 MHz. Figure 1 shows a block diagram of the sensor configured in linear mode, and in HDR mode.

AR0238

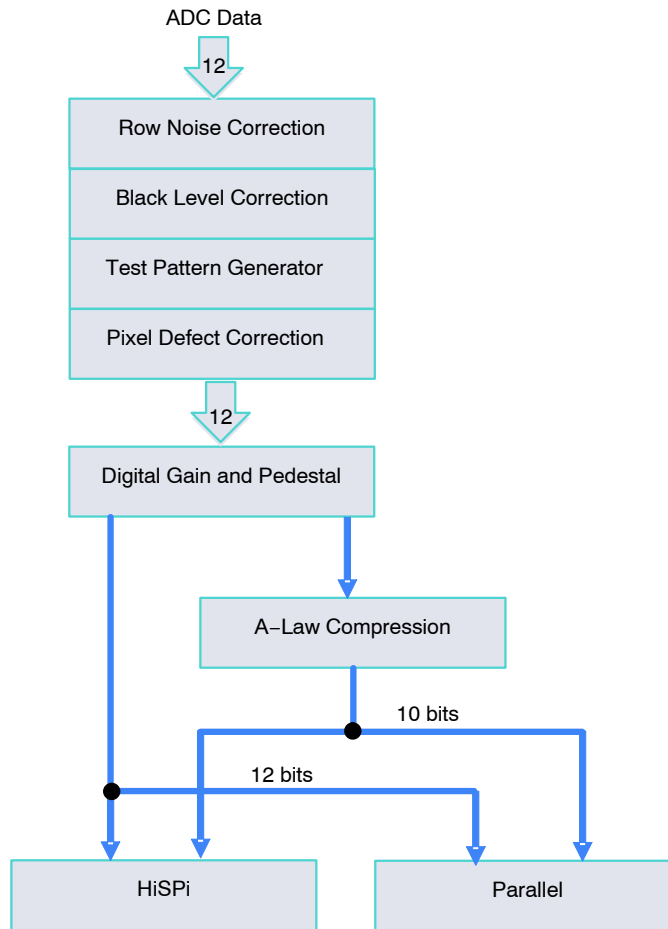
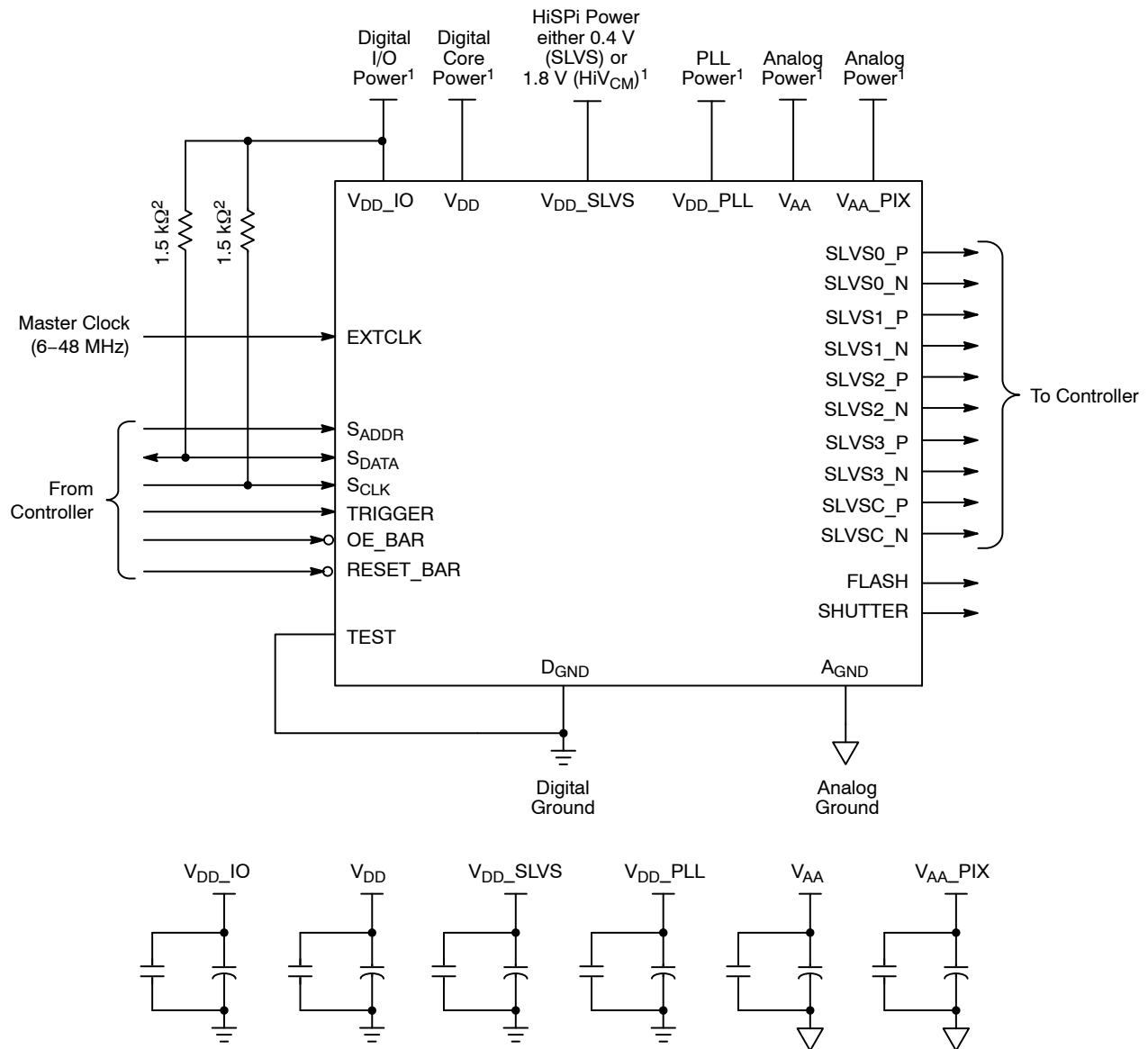

Figure 1. Block Diagram of AR0238

User interaction with the sensor is through the two-wire serial bus, which communicates with the array control, analog signal chain, and digital signal chain. The core of the sensor is a 2.1 Mp Active-Pixel Sensor array. The timing and control circuitry sequences through the rows of the array, resetting and then reading each row in turn. In the time interval between resetting a row and reading that row, the pixels in the row integrate incident light. The exposure is controlled by varying the time interval between reset and readout. Once a row has been read, the data from the columns is sequenced through an analog signal chain

(providing offset correction and gain), and then through an analog-to-digital converter (ADC). The output from the ADC is a 12-bit value for each pixel in the array. The ADC output passes through a digital processing signal chain (which provides further data path corrections and applies digital gain). The sensor also offers a high dynamic range mode of operation where two images are taken using different exposures. These images are output from the sensor and the ISP must combine them into one high dynamic range image.

AR0238



Notes:

1. All power supplies must be adequately decoupled.
2. ON Semiconductor recommends a resistor value of 1.5 kΩ, but a greater value may be used for slower two-wire speed.
3. The parallel interface output pads can be left unconnected if the serial output interface is used.
4. ON Semiconductor recommends that 0.1 μF and 10 μF decoupling capacitors for each power supply are mounted as close as possible to the pad. Actual values and results may vary depending on the layout and design considerations. Refer to the AR0237AT demo headboard schematics for circuit recommendations.
5. ON Semiconductor recommends that analog power planes are placed in a manner such that coupling with the digital power planes is minimized.
6. I/O signals voltage must be configured to match VDD_IO voltage to minimize any leakage currents.

Figure 2. Typical Configuration: Serial Four-Lane HiSPi Interface

AR0238

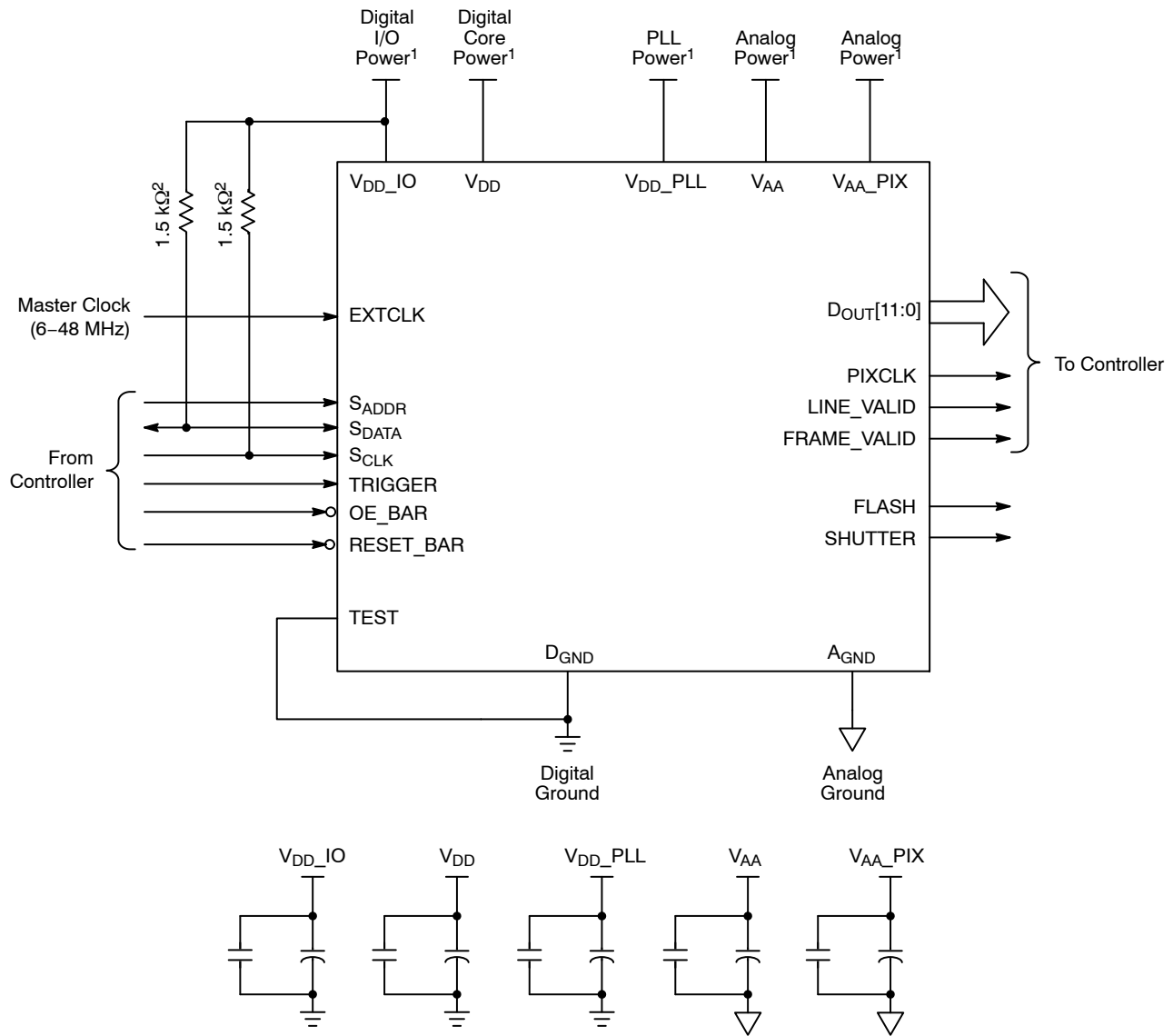

Notes:

1. All power supplies must be adequately decoupled.
2. ON Semiconductor recommends a resistor value of 1.5 kΩ, but a greater value may be used for slower two-wire speed.
3. The serial interface output pads can be left unconnected if the parallel output interface is used.
4. ON Semiconductor recommends that 0.1 μF and 10 μF decoupling capacitors for each power supply are mounted as close as possible to the pad. Actual values and results may vary depending on the layout and design considerations. Refer to the AR0237AT demo headboard schematics for circuit recommendations.
5. ON Semiconductor recommends that analog power planes are placed in a manner such that coupling with the digital power planes is minimized.
6. I/O signals voltage must be configured to match V_{DD_IO} voltage to minimize any leakage currents.
7. The EXTCLK input is limited to 6–48 MHz.

Figure 3. Typical Configuration: Parallel Pixel Data Interface

AR0238

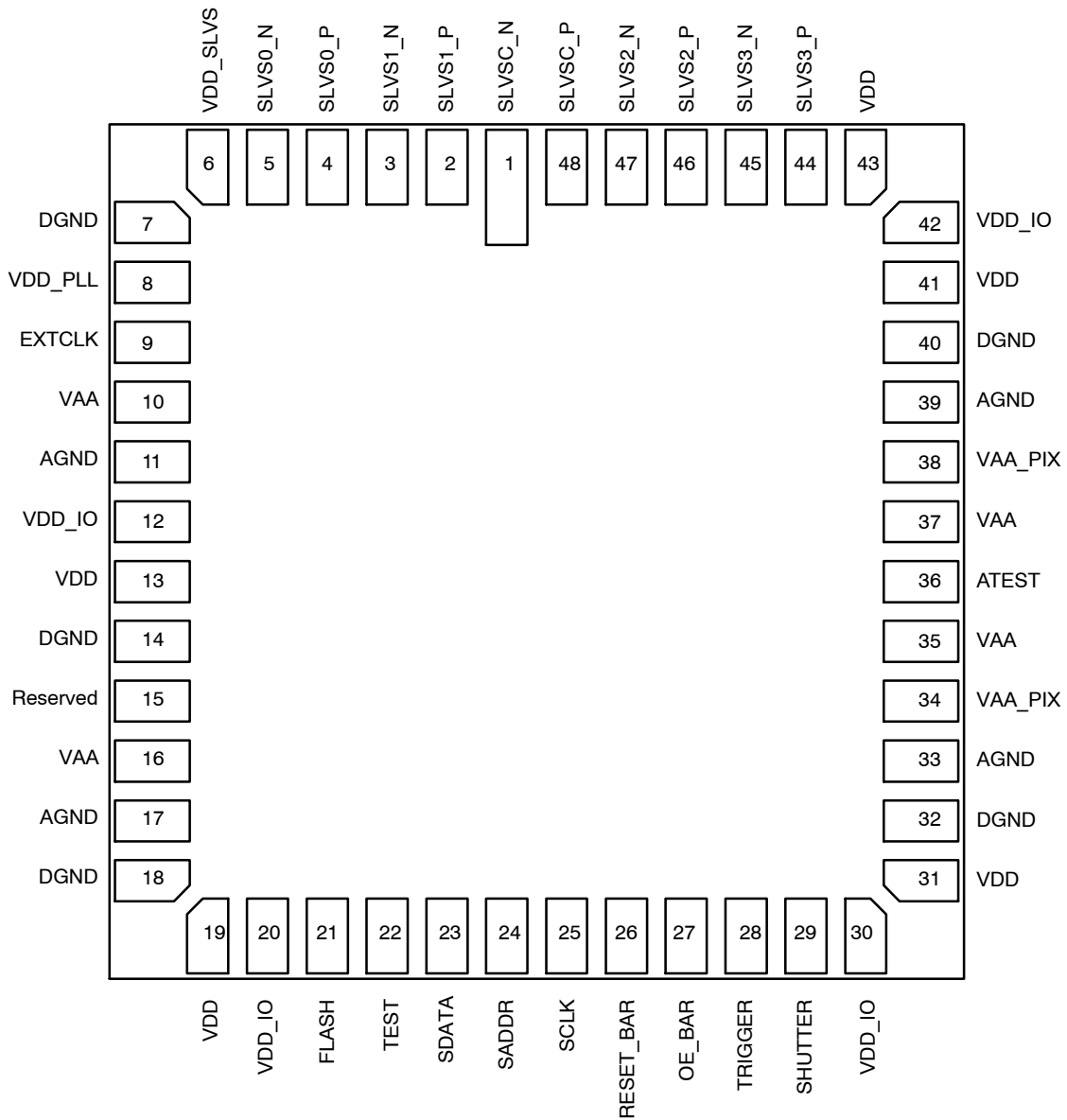

(Top View - Lead Down)

Figure 4. HiSPi 48-Lead mPLCC Package

AR0238

Table 3. PIN DESCRIPTIONS, HiSPi 48-Lead mPLCC

DS Name	mPLCC Pin	Type	Description
SLVSC_N	1	Output	HiSPi serial DDR clock differential N
SLVS1_P	2	Output	HiSPi serial data, lane 1, differential P
SLVS1_N	3	Output	HiSPi serial data, lane 1, differential N
SLVS0_P	4	Output	HiSPi serial data, lane 0, differential P
SLVS0_N	5	Output	HiSPi serial data, lane 0, differential N
VDD_SLVS	6	Power	0.3 V–0.6 V or 1.7 V – 1.9 V port to HiSPi Output Driver. Set the High_VCM (R0x306E[9]) bit to 1 when configuring VDD_SLVS to 1.7 V – 1.9 V.
DGND	7, 14, 18, 32, 40	Power	Digital ground
VDD_PLL	8	Power	PLL power, 2.8 V nominal
EXTCLK	9	Input	External input clock
VAA	10, 16, 35, 37	Power	Analog power, 2.8 V nominal
AGND	11, 17, 33, 39	Power	Analog ground.
VDD_IO	12, 20, 30, 42	Power	I/O supply power, 1.8/2.8 V nominal
VDD	13, 19, 31, 41, 43	Power	Digital power, 1.8 V nominal
Reserved	15	–	Reserved, NC
FLASH	21	Output	Flash control output
TEST	22	Input	Manufacturing test enable pin (connect to Dgnd)
SDATA	23	I/O	Two-Wire Serial data I/O
SADDR	24	Input	Two-Wire Serial address select. 0: 0x20. 1: 0x30
SCLK	25	Input	Two-Wire Serial clock input
RESET_BAR	26	Input	Asynchronous reset (active LOW). All settings are restored to factory default.
OE_BAR	27	Input	Output enable (active LOW)
TRIGGER	28	Input	Exposure synchronization input
SHUTTER	29	Output	Control for external mechanical shutter. Can be left floating if not used.
VAA_PIX	34, 38	Power	Pixel power, 2.8 V nominal
ATEST	36	–	Reserved, NC
SLVS3_P	44	Output	HiSPi serial data, lane 3, differential P
SLVS3_N	45	Output	HiSPi serial data, lane 3, differential N
SLVS2_P	46	Output	HiSPi serial data, lane 2, differential P
SLVS2_N	47	Output	HiSPi serial data, lane 2, differential N
SLVSC_P	48	Output	HiSPi serial DDR clock differential P

NOTE: The 36 thermal connection pads should be all soldered to DGND plane for better thermal conductivity. Refer to PACKAGE DIMENSIONS for details..

AR0238

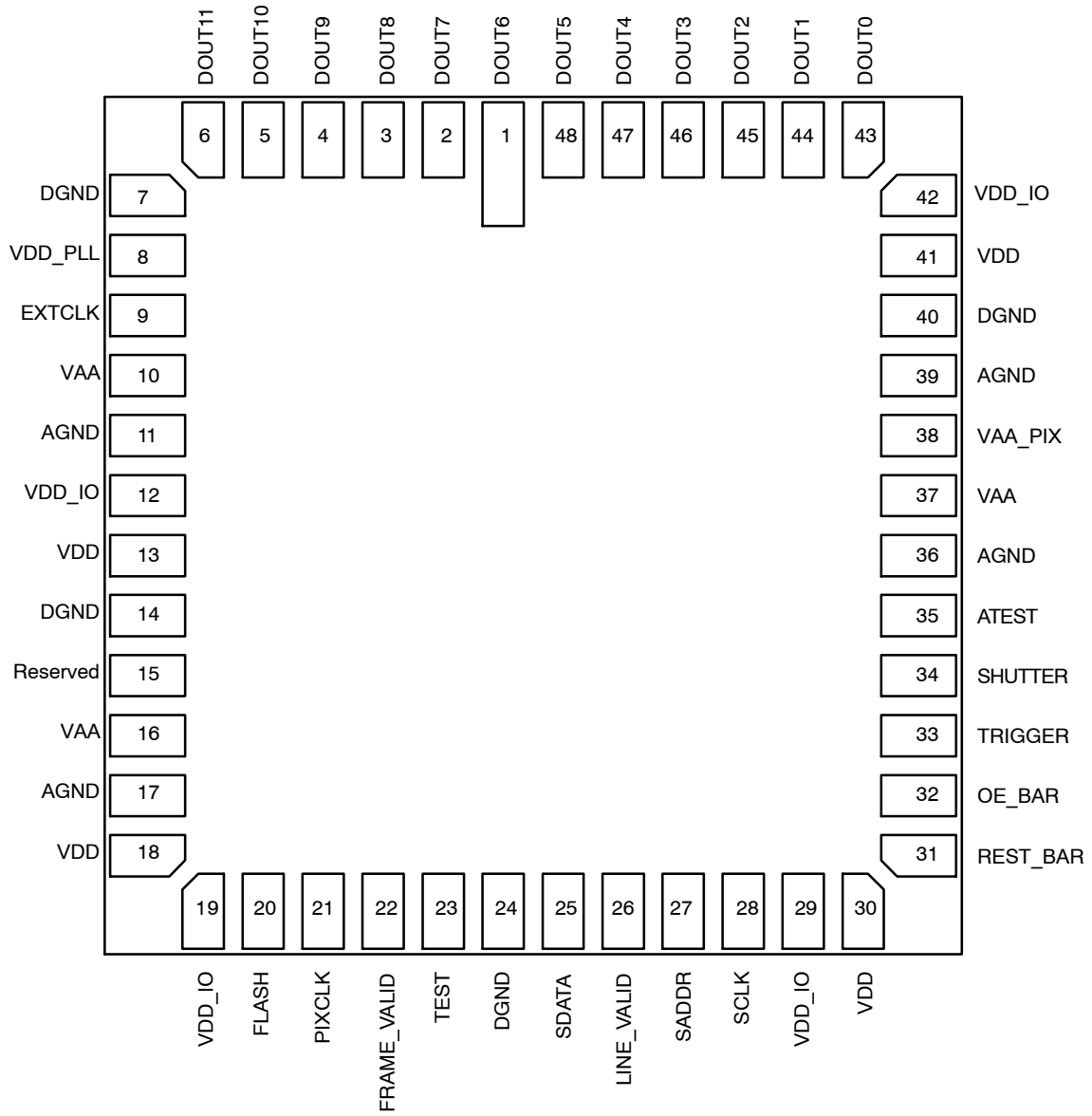

Figure 5. 48-Lead Parallel mPLCC

Table 4. 48–Lead PARALLEL mPLCC

Name	mPLCC Pin	Type	Description
DOUT6	1	Output	Data output 6
DOUT7	2	Output	Data output 7
DOUT8	3	Output	Data output 8
DOUT9	4	Output	Data output 9
DOUT10	5	Output	Data output 10
DOUT11	6	Power	Data output 11
DGND	7, 14, 24, 40	Power	Digital ground
VDD_PLL	8	Power	PLL power, 2.8 V nominal
EXTCLK	9	Input	External input clock
VAA	10, 16, 37	Power	Analog power, 2.8 V nominal
AGND	11, 17, 36, 39	Power	Analog Ground
VDD_IO	12, 19, 29, 42	Power	I/O supply power, 1.8/2.8 V nominal
VDD	13, 18, 30, 41	Power	Digital power, 1.8 V nominal
Reserved	15	–	Reserved, NC
FLASH	20	Power	Flash control output
PIXCLK	21	Output	Pixel Clock
FRAME_VALID	22	Output	Frame Valid
TEST	23	Input	Manufacturing test enable pin (connect to DGNG)
SDATA	25	I/O	Two-Wire Serial data I/O
LINE_VALID	26	Output	Line Valid
SADDR	27	Input	Two-Wire Serial address select. 0: 0x20, 1: 0x30
SCLK	28	Input	Two-Wire Serial clock input
RESET_BAR	31	Input	Asynchronous reset (active LOW). All settings are restored to factory default
OE_BAR	32	Input	Output enable (active LOW)
TRIGGER	33	Input	Exposure synchronization input
SHUTTER	34	Output	Control for external mechanical shutter. Can be left floating if not used.
ATEST	35	–	Reserved, NC
VAA_PIX	38	Power	Pixel power, 2.8 V nominal
DOUT0	43	Output	Data Output 0
DOUT1	44	Output	Data Output 1
DOUT2	45	Output	Data Output 2
DOUT3	46	Output	Data Output 3
DOUT4	47	Output	Data Output 4
DOUT5	48	Output	Data Output 5

NOTE: The 29 thermal connection pads should be all soldered to DGND plane for better thermal conductivity. Refer to PACKAGE DIMENSIONS for details.

PIXEL DATA FORMAT

PIXEL ARRAY STRUCTURE

While the sensor's format is 1928 x 1088, additional active columns and active rows are included for use when horizontal or vertical mirrored readout is enabled, to allow

readout to start on the same pixel. The pixel adjustment is always performed for mono-chrome or color versions. The active area is surrounded with optically transparent dummy pixels to improve image uniformity within the active area. Not all dummy pixels or barrier pixels can be read out.

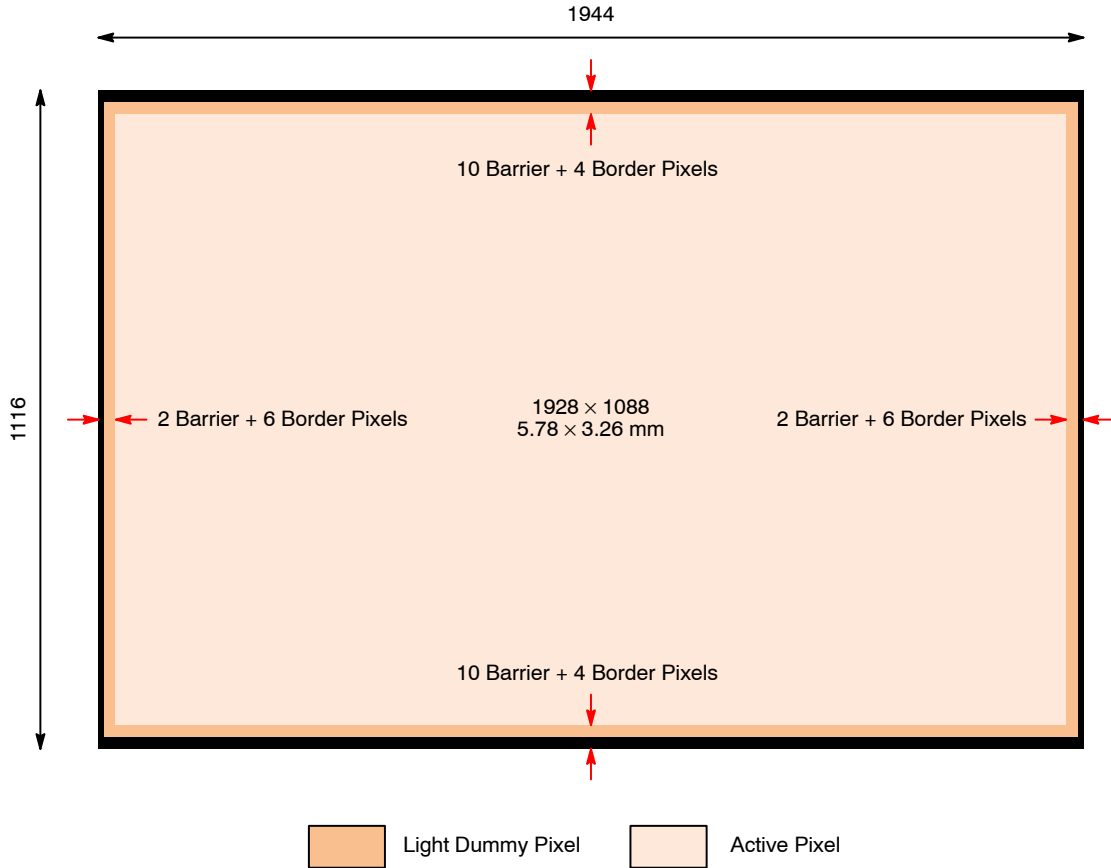

Figure 6. Pixel Array Description

AR0238

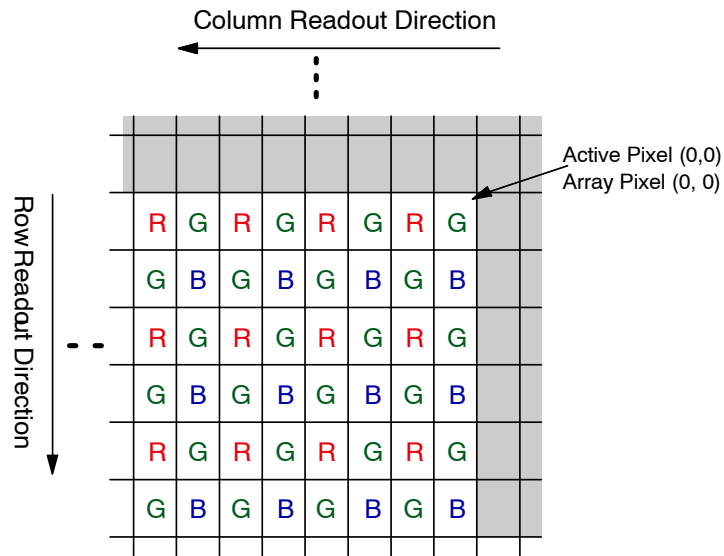

Figure 7. Pixel Color Pattern Detail (RGB) (Top Right Corner)

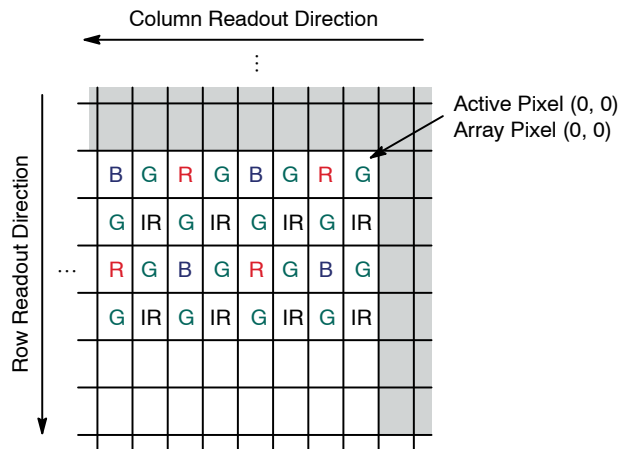

Figure 8. Pixel Color Pattern Detail (RGB-IR) (Top Right Corner)

DEFAULT READOUT ORDER

By convention, the sensor core pixel array is shown with pixel (0,0) in the top right corner (see Figure 7). This reflects the actual layout of the array on the die. Also, the first pixel data read out of the sensor in default condition is that of pixel (10, 14).

When the sensor is imaging, the active surface of the sensor faces the scene as shown in Figure 9. When the image is read out of the sensor, it is read one row at a time, with the rows and columns sequenced as shown in Figure 9.

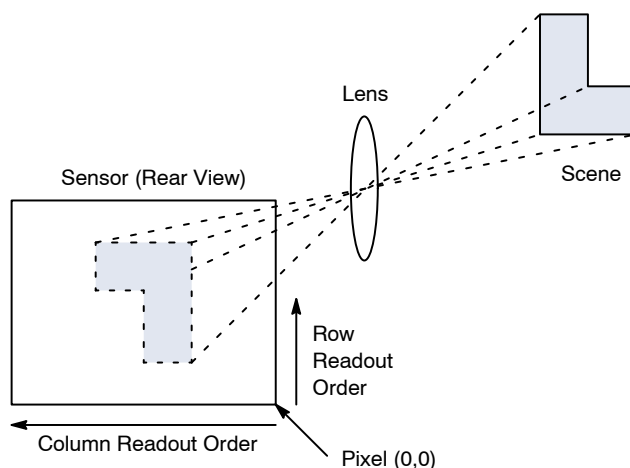

Figure 9. Imaging a Scene

FEATURES OVERVIEW

For a complete description, recommendations, and usage guidelines for product features, refer to the AR0238 Developer Guide.

3.0 μm Dual Conversion Gain Pixel

To improve the low light performance and keep the high dynamic range, a large (3.0 μm) dual conversion gain pixel is implemented for better image optimization. With a dual conversion gain pixel, the conversion gain of the pixel may be dynamically changed to better adapt the pixel response based on dynamic range of the scene. This gain can be switched manually or automatically by an auto exposure control module.

HDR

By default, the sensor powers up in Linear Mode. One can change to HDR Mode. The HDR scheme used is multi-exposure HDR. This allows the sensor to handle up to 96 dB of dynamic range. In HDR mode, the sensor sequentially captures two exposures by maintaining two separate read and reset pointers that are interleaved within the rolling shutter readout. The exposure ratio may be set to 4x, 8x, 16x, or 32x. Sensor also provides flexibility to choose any exposure ratio by setting number of t2 exposure rows independent of the t1 exposure. The data will be output as line interleaved data as described in the T1/T2 Line Interleaved Mode section. There is also an option to output either T1 only or T2 only.

RESOLUTION

The active array supports a maximum of 1928x1088 pixels to support 1080p resolution. Utilizing a 3.0 μm pixel will result in an optical format of 1/2.7-inch (approximately 6.6 mm diagonal).

FRAME RATE

At full (1080p) resolution, the AR0238 is capable of running up to 60 fps in linear mode and 30 fps in line interleaved mode.

IMAGE ACQUISITION MODE

The AR0238 supports two image acquisition modes:

- Electronic rolling shutter (ERS) mode

This is the normal mode of operation. When the AR0238 is streaming, it generates frames at a fixed rate, and each frame is integrated (exposed) using the ERS. When ERS mode is in use, timing and control logic within the sensor sequences through the rows of the array, resetting and then reading each row in turn. In the time interval between resetting a row and subsequently reading that row, the pixels in the row integrate incident light. The integration (exposure) time is controlled by varying the time between row reset and row readout. For each row in a frame, the time between row reset and row readout is the same, leading to a uniform integration time across the frame. When the integration time is changed (by using the two-wire serial interface to change register settings), the timing and control logic controls the transition from old to new integration time in such a way that the stream of output frames from the AR0238 switches cleanly from the old integration time to the new while only generating frames with uniform integration. See “Changes to Integration Time” in the AR0238 Register Reference.

- Global reset mode.

This mode can be used to acquire a single image at the current resolution. In this mode, the end point of the pixel integration time is controlled by an external electromechanical shutter, and the AR0238 provides control signals to interface to that shutter. The benefit of using an external electromechanical shutter is that it eliminates the visual artifacts associated with ERS operation. Visual artifacts arise in ERS operation, particularly at low frame rates, because an ERS image effectively integrates each row of the pixel array at a different point in time.

EMBEDDED DATA AND STATISTICS

The AR0238 has the capability to output image data and statistics embedded within the frame timing. There are two types of information embedded within the frame readout.

AR0238

- Embedded Data:
If enabled, these are displayed on the two rows immediately before the first active pixel row is displayed.
- Embedded Statistics:
If enabled, these are displayed on the two rows immediately after the last active pixel row is displayed.

MULTI-CAMERA SYNCHRONIZATION

SLAVE MODE

The slave mode feature of the AR0238 supports triggering the start of a frame readout from an input signal that is supplied from an external ASIC. The slave mode signal allows for precise control of frame rate and register change updates.

Context Switching and Register Updates

The user has the option of using the highly configurable context memory, or a simplified implementation in which

only a subset of registers is available for switching. The AR0238 supports a highly configurable context switching RAM of size 256 x 16. Within this Context Memory, changes to any register may be stored. The register set for each context must be the same, but the number of contexts and registers per context are limited only by the size of the context memory.

Alternatively, the user may switch between two predefined register sets A and B by writing to a context switch change bit. When the context switch is configured to context A the sensor will reference the context A registers. If the context switch is changed from A to B during the readout of frame n, the sensor will then reference the context B coarse_integration_time registers in frame n+1 and all other context B registers at the beginning of reading frame n+2. The sensor will show the same behavior when changing from context B to context A. The registers listed in Table 5 are context-switchable:

Table 5. LIST OF CONFIGURABLE REGISTERS FOR CONTEXT A AND CONTEXT B

Context A	Context B
Register Description	Register Description
coarse_integration_time	coarse_integration_time_cb
line_length_pck	line_length_pck_cb
frame_length_lines	frame_length_lines_cb
row_bin	row_bin_cb
col_bin	col_bin_cb
fine_gain	fine_gain_cb
coarse_gain	coarse_gain_cb
coarse_integration_time2	coarse_integration_time2_cb
dcg_manual_set	dcg_manual_set_cb
dcg_manual_set_t1	dcg_manual_set_t1_cb
bypass_pix_comb	bypass_pix_cb
coarse_gain_t1	coarse_gain_t1_cb
fine_gain_t1	fine_gain_t1_cb
x_addr_start	x_addr_start_cb
y_addr_start	y_addr_start_cb
x_addr_end	x_addr_end_cb
y_addr_end	y_addr_end_cb
y_odd_inc	y_odd_inc_cb
x_odd_inc	x_odd_inc_cb
green1_gain	green1_gain_cb
blue_gain	blue_gain_cb
red_gain	red_gain_cb
green2_gain	green2_gain_cb
global_gain	global_gain_cb
operation_mode_ctrl	operation_mode_ctrl_cb
bypass_pix_comb	bypass_pix_comb_cb

ANALOG/DIGITAL GAINS

A programmable analog gain of 1.0x to 16x (linear and HDR) applied simultaneously to all color channels will be featured along with a digital gain of 1x to 16x that may be configured on a per color channel basis. Analog gain can be applied per exposure in line interleaved mode.

SKIPPING/BINNING MODES

The AR0238 supports subsampling. Subsampling allows the sensor to read out a smaller set of active pixels by either skipping, binning, or summing pixels within the readout window. Horizontal binning is achieved in the digital readout. The sensor will sample the combined 2x adjacent pixels within the same color plane. Vertical row binning is applied in the pixel readout. Row binning can be configured as 2x rows within the same color plane. Pixel skipping can be configured up to 2x in both the x-direction and y-direction. Skipping pixels in the x-direction will not reduce the row time. Skipping pixels in the y direction will reduce the number of rows from the sensor effectively reducing the frame time. Skipping will introduce image artifacts from aliasing.

The AR0238 supports row wise vertical binning. Row wise vertical summing is only supported in monochrome sensors.

CLOCKING OPTIONS

The sensor contains a phase-locked loop (PLL) that is used for timing generation and control. The required VCO clock frequency is attained through the use of a pre-PLL clock divider followed by a multiplier. The PLL multiplier should be an even integer. If an odd integer (M) is programmed, the PLL will default to the lower (M-1) value to maintain an even multiplier value. The multiplier is followed by a set of dividers used to generate the output clocks required for the sensor array, the pixel analog and digital readout paths, and the output parallel and serial interfaces. Use of the PLL is required when using the HiSPi interface.

TEMPERATURE SENSOR

The AR0238 sensor has a built-in PTAT-based temperature sensor, accessible through registers, that is capable of measuring die junction temperature. The value read out from the temperature sensor register is an ADC output value that needs to be converted downstream to a final temperature value in degrees Celsius. Since the PTAT device characteristic response is quite linear in the temperature range of operation required, a simple linear function can be used to convert the ADC output value to the final temperature in degrees Celsius.

A single reference point will be made available via register read as well as a slope for back-calculating the junction temperature value. An error of +/-5% or better over the full specified operating range of the sensor is to be expected.

SILICON / FIRMWARE / SEQUENCER REVISION INFORMATION

A revision register will be provided to read out (via I²C) silicon and sequencer/OTPM revision information. This will be helpful to distinguish among different lots of material if there are future OTPM or sequencer revisions.

LENS SHADING CORRECTION

The latest lens shading correction algorithm will be included for potential low Z height applications.

COMPRESSION

When the AR0238 is configured for linear mode operation, the sensor can optionally compress 12-bit data to 10-bit using A-law compression. The A-law compression is disabled by default.

PACKAGING

The AR0238 will be offered in a 11.43 x 11.43 48-Lead mPLCC package.

PARALLEL INTERFACE

The parallel pixel data interface uses these output-only signals:

- FRAME_VALID
- LINE_VALID
- PIXCLK
- DOUT[11:0]

HIGH SPEED SERIAL PIXEL (HISPI) INTERFACE

The HiSPi interface supports three protocols, Streaming-S, Streaming-SP, and Packetized SP. The streaming protocols conform to a standard video application where each line of active or intra-frame blanking provided by the sensor is transmitted at the same length. The Packetized SP protocol will transmit only the active data ignoring line-to-line and frame-to-frame blanking data.

The HiSPi interface building block is a unidirectional differential serial interface with four data and one double data rate (DDR) clock lanes. One clock for every four serial data lanes is provided for phase alignment across multiple lanes. The AR0238 supports serial data widths of 10 or 12 bits on one, two, or four lanes. The specification includes a DLL to compensate for differences in group delay for each data lane. The DLL is connected to the clock lane and each data lane, which acts as a control master for the output delay buffers. Once the DLL has gained phase lock, each lane can be delayed in

1/8 unit interval (UI) steps. This additional delay allows the user to increase the setup or hold time at the receiver circuits and can be used to compensate for skew introduced in PCB design. Delay compensation may be set for clock and/or data lines in the hispi_timing register R0x31C0. If the DLL timing adjustment is not required, the data and clock lane delay settings should be set to a default code of 0x0000 to reduce jitter, skew, and power dissipation.

AR0238

SENSOR CONTROL INTERFACE

The two-wire serial interface bus enables read/write access to control and status registers within the AR0238. The interface protocol uses a master/slave model in which a master controls one or more slave devices. The sensor acts as a slave device. The master generates a clock (SCLK) that is an input to the sensor and is used to synchronize transfers.

Data is transferred between the master and the slave on a bidirectional signal (SDATA). SDATA is pulled up to VDD_IO off-chip by a 1.5 kΩ resistor. Either the slave or master

device can drive SDATA LOW—the interface protocol determines which device is allowed to drive SDATA at any given time. The two-wire serial interface can run at 100 kHz or 400 kHz.

T1/T2 LINE INTERLEAVED MODE

The AR0238 outputs the T1 and T2 exposures separately, in a line interleaved format. The purpose of this is to enable off chip HDR linear combination and processing. See the AR0238 Developer Guide for more information.

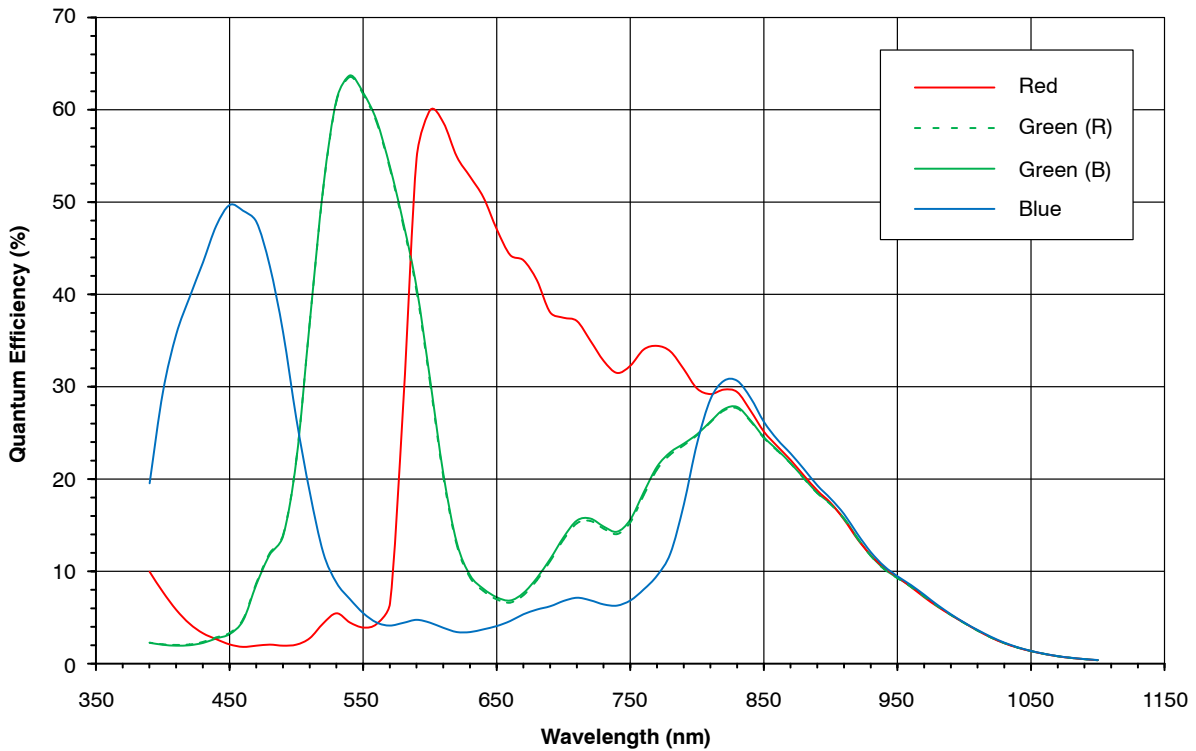

Figure 10. Quantum Efficiency – RGB

AR0238

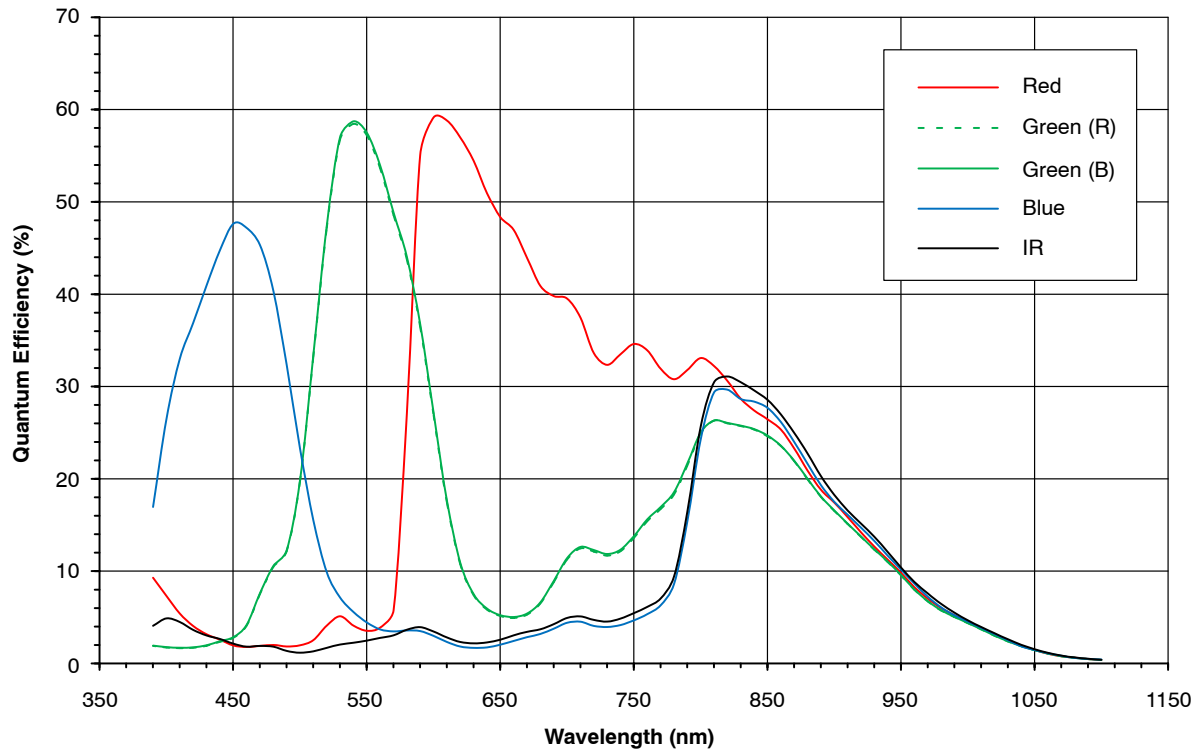
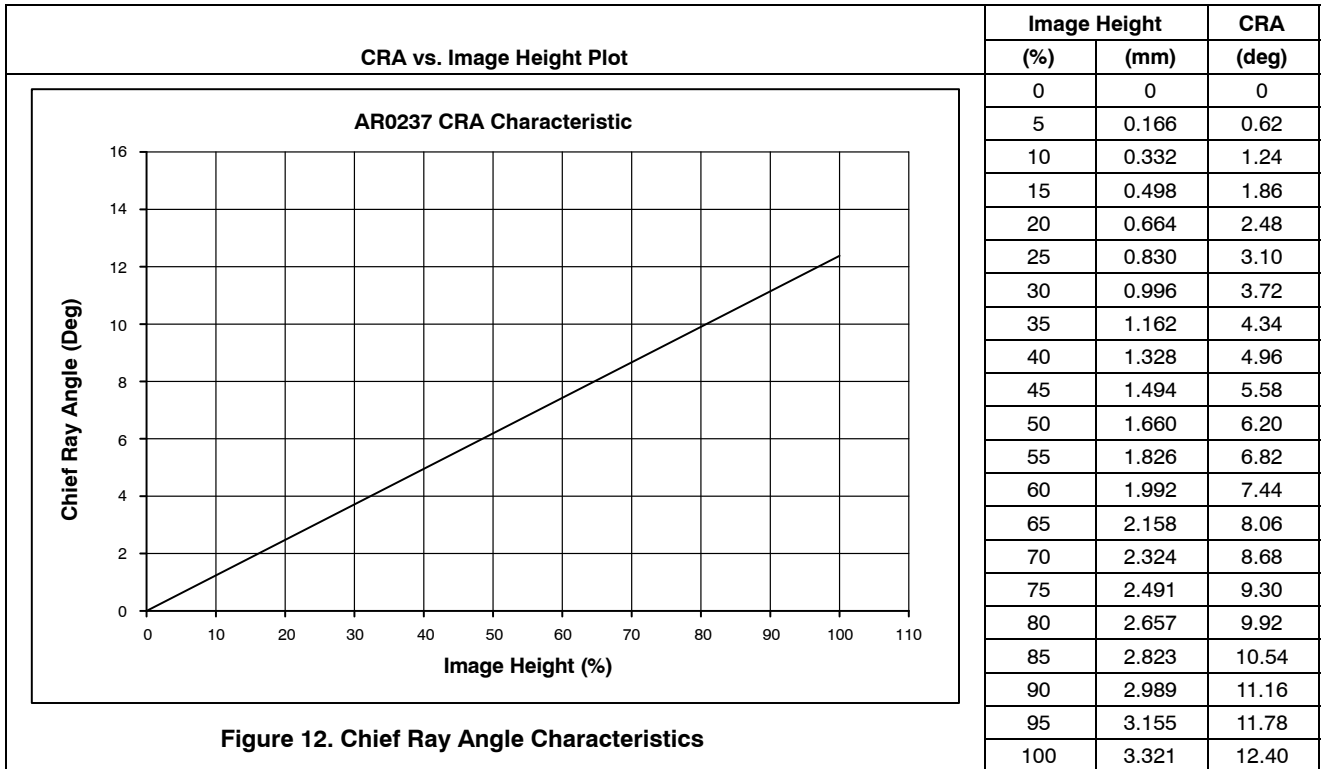

Figure 11. Quantum Efficiency – RGB-IR



ELECTRICAL SPECIFICATIONS

Unless otherwise stated, the following specifications apply under the following conditions:

- $V_{DD} = 1.8\text{ V } -0.10/+0.15;$
- $V_{DD_IO} = V_{DD_PLL} = V_{AA} = V_{AA_PIX} = 2.8\text{ V } \pm 0.3\text{ V};$
- $V_{DD_SLVS} = 0.4\text{ V } - 0.1/+0.2;$
- $T_A = -30^{\circ}\text{C to } +85^{\circ}\text{C};$
- Output load = 10 pF;

Frequency = 74.25 MHz;
HiSPi off.

TWO-WIRE SERIAL REGISTER INTERFACE

The electrical characteristics of the two-wire serial register interface (SCLK, SDATA) are shown in Figure 13 and Table 6.

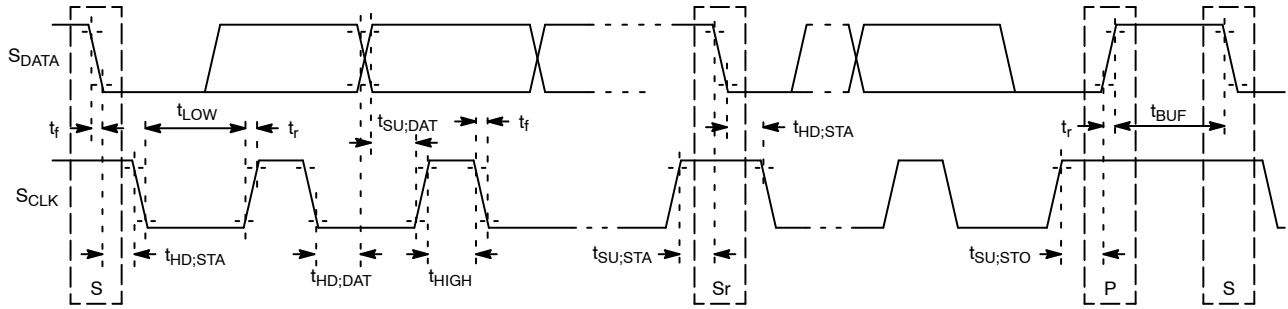

NOTE: Read sequence: For an 8-bit READ, read waveforms start after WRITE command and register address are issued.

Figure 13. Two-Wire Serial Bus Timing Parameters

Table 6. Two-Wire Serial Bus CharacteristicsfEXTCLK = 27 MHz; VDD = 1.8 V; VDD_IO = 2.8 V; VAA = 2.8 V; VAA_PIX = 2.8 V; VDD_PLL = 2.8 V; T_A = 25°C

Parameter	Symbol	Standard Mode		Fast Mode		Unit
		Min	Max	Min	Max	
SCLK Clock Frequency	fSCL	0	100	0	400	KHz
Hold time (repeated) START condition. After this period, the first clock pulse is generated	tHD;STA	4.0	–	0.6	–	μs
LOW period of the SCLK clock	tLOW	4.7	–	1.3	–	μs
HIGH period of the SCLK clock	tHIGH	4.0	–	0.6	–	μs
Set-up time for a repeated START condition	tSU;STA	4.7	–	0.6	–	μs
Data hold time	tHD;DAT	0 (Note 11)	3.45 (Note 12)	0 (Note 13)	0.9 (Note 12)	μs
Data set-up time	tSU;DAT	250	–	100 (Note 13)	–	ns
Rise time of both SDATA and SCLK signals	tr	–	1000	20 + 0.1Cb (Note 14)	300	ns
Fall time of both SDATA and SCLK signals	tf	–	300	20 + 0.1Cb (Note 14)	300	ns
Set-up time for STOP condition	tSU;STO	4.0	–	0.6	–	μs
Bus free time between a STOP and START condition	tBUF	4.7	–	1.3	–	μs
Capacitive load for each bus line	Cb	–	400	–	400	pF
Serial interface input pin capacitance	CIN_SI	–	3.3	–	3.3	pF
SDATA max load capacitance	CLOAD_SD	–	30	–	30	pF
SDATA pull-up resistor	RSD	1.5	4.7	1.5	4.7	kΩ

8. This table is based on I2C standard (v2.1 January 2000). Philips Semiconductor.

9. Two-wire control is I2C-compatible.

10. All values referred to VIHmin = 0.9 VDD and VILmax = 0.1 VDD levels. Sensor EXCLK = 27 MHz.

11. A device must internally provide a hold time of at least 300 ns for the SDATA signal to bridge the undefined region of the falling edge of SCLK.

12. The maximum tHD;DAT has only to be met if the device does not stretch the LOW period (tLOW) of the SCLK signal.

13. A Fast-mode I2C-bus device can be used in a Standard-mode I2C-bus system, but the requirement tSU;DAT 250 ns must then be met.

This will automatically be the case if the device does not stretch the LOW period of the SCLK signal. If such a device does stretch the LOW period of the SCLK signal, it must output the next data bit to the SDATA line $t_{r\max} + t_{SU;DAT} = 1000 + 250 = 1250$ ns (according to the Standard-mode I2C-bus specification) before the SCLK line is released.

14. Cb = total capacitance of one bus line in pF.

I/O TIMING

By default, the AR0238 launches pixel data, FV, and LV with the falling edge of PIXCLK. The expectation is that the user captures DOUT[11:0], FV, and LV using the rising edge of PIXCLK.

See Figure 14 below and Table 7 on page 19 for I/O timing (AC) characteristics.

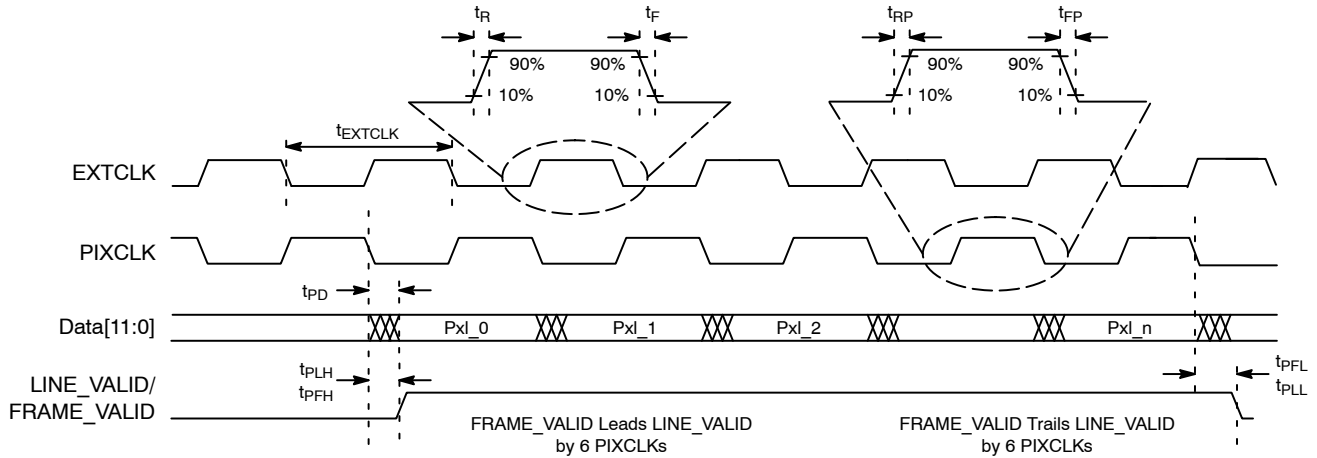

Figure 14. I/O Timing Diagram

Table 7. I/O TIMING CHARACTERISTICS

Symbol	Definition	Condition	Min	Typ	Max	Unit
$f_{EXTCLK1s}$	Input Clock Frequency		6	–	48	MHz
$t_{EXTCLK1}$	Input Clock Period		20.8	–	166	ns
t_R	Input Clock Rise Time		–	3	–	ns
t_F	Input Clock Fall Time		–	3	–	ns
t_{RP}	Pixclk Rise Time		2	3.5	5	ns
t_{FP}	Pixclk Fall Time		2	3.5	5	ns
t_{CP}	EXTCLK to PIXCLK Propagation Delay	Nominal Voltages, PLL Disabled	10	14	18	ns
f_{PIXCLK}	PIXCLK Frequency	Default, Nominal Voltages	6	–	74.25	MHz
t_{PD}	PIXCLK to Data Valid	Default, Nominal Voltages	0	2.5	5	ns
t_{PFH}	PIXCLK to FV HIGH	Default, Nominal Voltages	–2	3	6	ns
t_{PLH}	PIXCLK to LV HIGH	Default, Nominal Voltages	–2	3	6	ns
t_{PFL}	PIXCLK to FV LOW	Default, Nominal Voltages	–2	2.5	6	ns
t_{PLL}	PIXCLK to LV LOW	Default, Nominal Voltages	–2	2.5	6	ns
C_{LOAD}	Output Load Capacitance		–	< 10	–	pF
C_{IN}	Input Pin Capacitance		–	2.5	–	pF

NOTE: I/O timing characteristics are measured under the following conditions:

- Temperature is 25°C ambient
- 10 pF load
- 1.8 V I/O supply voltage

DC ELECTRICAL CHARACTERISTICS

The DC electrical characteristics are shown in the tables below.

Table 8. DC ELECTRICAL CHARACTERISTICS

Symbol	Definition	Condition	Min	Typ	Max	Unit
VDD	Core digital voltage		1.7	1.8	1.95	V
VDD_IO	I/O digital voltage		1.7/2.5	1.8/2.8	1.9/3.1	V
VAA	Analog voltage		2.5	2.8	3.1	V
VAA_PIX	Pixel supply voltage		2.5	2.8	3.1	V
VDD_PLL	PLL supply voltage		2.5	2.8	3.1	V
VDD_SLVS	HiSPi supply voltage		0.3	0.4	0.6	V
VIH	Input HIGH voltage		VDD_IO*0.7	–	–	V
VIL	Input LOW voltage		–	–	VDD_IO*0.3	V
IIN	Input leakage current	No pull-up resistor; VIN = VDD_IO or DGND	20	–	–	μA
VOH	Output HIGH voltage		VDD_IO–0.3	–	–	V
VOL	Output LOW voltage		–	–	0.4	V
IOH	Output HIGH current	At specified VOH	–22	–	–	mA
IOL	Output LOW current	At specified VOL	–	–	22	mA

Table 9. ABSOLUTE MAXIMUM RATINGS

Symbol	Definition	Condition	Min	Max	Unit
VDD_MAX	Core digital voltage		–0.3	2.4	V
VDD_IO_MAX	I/O digital voltage		–0.3	4	V
VAA_MAX	Analog voltage		–0.3	4	V
VAA_PIX	Pixel supply voltage		–0.3	4	V
VDD_PLL	PLL supply voltage		–0.3	4	V
VDD_SLVS_MAX	HiSPi I/O digital voltage		–0.3	2.4	V
tST	Storage temperature		–40	85	°C

Stresses exceeding those listed in the Maximum Ratings table may damage the device. If any of these limits are exceeded, device functionality should not be assumed, damage may occur and reliability may be affected.

Table 10. 1080p30 LINEAR 74 MHZ PARALLEL 2.8 V

(Operating currents are measured in mA at the following conditions: $V_{AA} = V_{AA_PIX} = V_{DD_PLL} = V_{DD_IO} = 2.8$ V; $V_{DD} = 1.8$ V; PLL Enabled and PIXCLK = 74.25 MHz; Low power mode enabled; $T_A = 25^\circ\text{C}$)

Definition	Condition	Symbol	Voltage	Min	Typ	Max	Unit
Digital Operating Current	Streaming 1080p30	I_{DD}	1.8	20	34	50	mA
I/O Digital Operating Current	Streaming 1080p30	I_{DD_IO}	2.8	15	28	50	mA
Analog Operating Current	Streaming 1080p30	I_{AA}	2.8	15	26	50	mA
Pixel Supply Current	Streaming 1080p30	I_{AA_PIX}	2.8	1	3	7	mA
PLL Supply Current	Streaming 1080p30	I_{DD_PLL}	2.8	5.5	6.4	7	mA
			Power	138.2	238.72	409.2	mW

Table 11. 1080p30 LINEAR 74 MHZ PARALLEL 1.8 V

(Operating currents are measured in mA at the following conditions: $V_{AA} = V_{AA_PIX} = V_{DD_PLL} = 2.8$ V; $V_{DD} = V_{DD_IO} = 1.8$ V; PLL Enabled and PIXCLK = 74.25 MHz; Low power mode enabled; $T_A = 25^\circ\text{C}$ Dark Image, 8x Analog Gain, HCG, 20 ms integration time)

Definition	Condition	Symbol	Voltage	Min	Typ	Max	Unit
Digital Operating Current	Streaming 1080p30	I_{DD}	1.8	20	34	50	mA
I/O Digital Operating Current	Streaming 1080p30	I_{DD_IO}	1.8	10	14	30	mA
Analog Operating Current	Streaming 1080p30	I_{AA}	2.8	15	26	50	mA
Pixel Supply Current	Streaming 1080p30	I_{AA_PIX}	2.8	1	3	7	mA
PLL Supply Current	Streaming 1080p30	I_{DD_PLL}	2.8	5.5	6.4	7	mA
			Power	114.2	185.52	323.2	mW

Table 12. 1080p30 LINEAR 74 MHZ HISPI SLVS

(Operating currents are measured in mA at the following conditions: $V_{AA} = V_{AA_PIX} = V_{DD_PLL} = 2.8$ V; $V_{DD} = V_{DD_IO} = 1.8$ V; $V_{DD_SLVS} = 0.4$ V; PLL Enabled and PIXCLK = 74.25 MHz; 4-lane HiSPi mode; Low power mode enabled; $T_A = 25^\circ\text{C}$ Dark Image, 8x Analog Gain, HCG, 20 ms integration time)

Definition	Condition	Symbol	Voltage	Min	Typ	Max	Unit
Digital Operating Current	Streaming 1080p30	I_{DD}	1.8	25	44	65	mA
Analog Operating Current	Streaming 1080p30	I_{AA}	2.8	15	26	50	mA
Pixel Supply Current	Streaming 1080p30	I_{AA_PIX}	2.8	1	3	7	mA
PLL Supply Current	Streaming 1080p30	I_{DD_PLL}	2.8	6	7.5	8.5	mA
SLVS Supply Current	Streaming 1080p30	I_{DD_SLVS}	0.4	6	9.5	14	mA
			Power	109	185.2	306	mW

Table 13. 1080p30 LINEAR 74 MHZ HISPI HIV_{CM}

(Operating currents are measured in mA at the following conditions: $V_{AA} = V_{AA_PIX} = V_{DD_PLL} = 2.8$ V; $V_{DD} = V_{DD_IO} = V_{DD_SLVS} = 1.8$ V; PLL Enabled and PIXCLK = 74.25 MHz; 4-lane HiSPi mode; Low power mode enabled; $T_A = 25^\circ\text{C}$ Dark Image, 8x Analog Gain, HCG, 20 ms integration time)

Definition	Condition	Symbol	Voltage	Min	Typ	Max	Unit
Digital Operating Current	Streaming 1080p30	I_{DD}	1.8	25	44	65	mA
Analog Operating Current	Streaming 1080p30	I_{AA}	2.8	15	26	50	mA
Pixel Supply Current	Streaming 1080p30	I_{AA_PIX}	2.8	1	3	7	mA
PLL Supply Current	Streaming 1080p30	I_{DD_PLL}	2.8	6	7.5	8.5	mA
SLVS Supply Current	Streaming 1080p30	I_{DD_SLVS}	1.8	12	20	35	mA
			Power	128.2	217.4	363.4	mW

Table 14. 1080p60 LINEAR 74 MHZ HISPI SLVS

(Operating currents are measured in mA at the following conditions: $V_{AA} = V_{AA_PIX} = V_{DD_PLL} = 2.8$ V; $V_{DD} = V_{DD_IO} = 1.8$ V; $V_{DD_SLVS} = 0.4$ V; PLL Enabled and PIXCLK = 74.25 MHz; 4-lane HiSPi mode; $T_A = 25^\circ\text{C}$ Dark Image, 8x Analog Gain, HCG, 20 ms integration time)

Definition	Condition	Symbol	Voltage	Min	Typ	Max	Unit
Digital Operating Current	Streaming 1080p60	I_{DD}	1.8	50	88	130	mA
Analog Operating Current	Streaming 1080p60	I_{AA}	2.8	20	36	60	mA
Pixel Supply Current	Streaming 1080p60	I_{AA_PIX}	2.8	1	4	8	mA
PLL Supply Current	Streaming 1080p60	I_{DD_PLL}	2.8	7	8.5	9.5	mA
SLVS Supply Current	Streaming 1080p60	I_{DD_SLVS}	0.4	6	9.5	14	mA
			Power	170.8	298	442.6	mW

Table 15. 1080p60 LINEAR 74 MHZ HISPI HIV_{CM}

(Operating currents are measured in mA at the following conditions: $V_{AA} = V_{AA_PIX} = V_{DD_PLL} = 2.8$ V; $V_{DD} = V_{DD_IO} = 1.8$ V; $V_{DD_SLVS} = 1.8$ V; PLL Enabled and PIXCLK = 74.25 MHz; 4-lane HiSPi mode; $T_A = 25^\circ\text{C}$ Dark Image, 8x Analog Gain, HCG, 20 ms integration time)

Definition	Condition	Symbol	Voltage	Min	Typ	Max	Unit
Digital Operating Current	Streaming 1080p60	I_{DD}	1.8	50	88	130	mA
Analog Operating Current	Streaming 1080p60	I_{AA}	2.8	20	36	60	mA
Pixel Supply Current	Streaming 1080p60	I_{AA_PIX}	2.8	1	4	8	mA
PLL Supply Current	Streaming 1080p60	I_{DD_PLL}	2.8	7	8.5	9.5	mA
SLVS Supply Current	Streaming 1080p60	I_{DD_SLVS}	1.8	12	20	35	mA
			Power	190	330.2	500	mW

Table 16. 1080p30 LINE-INLEAVED 74MHZ HISPI SLVS

(Operating currents are measured in mA at the following conditions: $V_{AA} = V_{AA_PIX} = V_{DD_PLL} = 2.8$ V; $V_{DD} = V_{DD_IO} = 1.8$ V; $V_{DD_SLVS} = 0.4$ V; PLL Enabled and PIXCLK = 74.25 MHz; 4-lane HiSPi mode; $T_A = 25^\circ\text{C}$ Dark Image, 8x Analog Gain, HCG, 20 ms integration time)

Definition	Condition	Symbol	Voltage	Min	Typ	Max	Unit
Digital Operating Current	Streaming 1080p30	I_{DD}	1.8	50	88	130	mA
Analog Operating Current	Streaming 1080p30	I_{AA}	2.8	20	36	60	mA
Pixel Supply Current	Streaming 1080p30	I_{AA_PIX}	2.8	1	4	8	mA
PLL Supply Current	Streaming 1080p30	I_{DD_PLL}	2.8	7	8.5	9.5	mA
SLVS Supply Current	Streaming 1080p30	I_{DD_SLVS}	0.4	6	9.5	14	mA
			Power	170.8	298	442.6	mW

Table 17. 1080p30 LINE-INLEAVED 74MHZ HISPI HIV_{CM}

(Operating currents are measured in mA at the following conditions: $V_{AA} = V_{AA_PIX} = V_{DD_PLL} = 2.8$ V; $V_{DD} = V_{DD_IO} = 1.8$ V; $V_{DD_SLVS} = 1.8$ V; PLL Enabled and PIXCLK = 74.25 MHz; 4-lane HiSPi mode; $T_A = 25^\circ\text{C}$ Dark Image, 8x Analog Gain, HCG, 20 ms integration time)

Definition	Condition	Symbol	Voltage	Min	Typ	Max	Unit
Digital Operating Current	Streaming 1080p30	I_{DD}	1.8	50	88	130	mA
Analog Operating Current	Streaming 1080p30	I_{AA}	2.8	20	36	60	mA
Pixel Supply Current	Streaming 1080p30	I_{AA_PIX}	2.8	1	4	8	mA
PLL Supply Current	Streaming 1080p30	I_{DD_PLL}	2.8	7	8.5	9.5	mA
SLVS Supply Current	Streaming 1080p30	I_{DD_SLVS}	1.8	12	20	35	mA
			Power	190	330.2	500	mW

AR0238

HiSPi ELECTRICAL SPECIFICATIONS

The ON Semiconductor AR0238 sensor supports both SLVS and HiVCM HiSPi modes. Refer to the High-Speed Serial Pixel (HiSPi) Interface Physical Layer Specification v2.00.00 for electrical definitions, specifications, and timing information. The VDD_SLVS supply in this datasheet

corresponds to VDD_TX in the HiSPi Physical Layer Specification. Similarly, VDD is equivalent to VDD_HiSPi as referenced in the specification. The DLL as implemented on AR0238 is limited in the number of available delay steps and differs from the HiSPi specification as described in this section.

Table 18. CHANNEL SKEW

Measurement Conditions: VDD_HiSPi = 1.8 V; VDD_HiSPi_TX = 0.4V; Data Rate = 480 Mbps;
DLL set to 0

Data Lane Skew in Reference to Clock	tCHSKEW1PHY	-150	ps
--------------------------------------	-------------	------	----

POWER-ON RESET AND STANDBY TIMING

POWER-UP SEQUENCE

The recommended power-up sequence for the AR0238 is shown in Figure 15. The available power supplies (VDD_IO, VDD, VDD_SLVS, VDD_PLL, VAA, VAA_PIX) must have the separation specified below.

1. Turn on VDD_PLL power supply.
2. After 100 μ s, turn on VAA and VAA_PIX power supply.
3. After 100 μ s, turn on VDD_IO power supply.
4. After 100 μ s, turn on VDD power supply.

5. After 100 μ s, turn on VDD_SLVS power supply.
6. After the last power supply is stable, enable EXTCLK.
7. Assert RESET_BAR for at least 1 ms. The parallel interface will be tri-stated during this time.
8. Wait 150000 EXTCLKs (for internal initialization into software standby).
9. Configure PLL, output, and image settings to desired values.
10. Wait 1ms for the PLL to lock.
11. Set streaming mode (R0x301a[2] = 1).

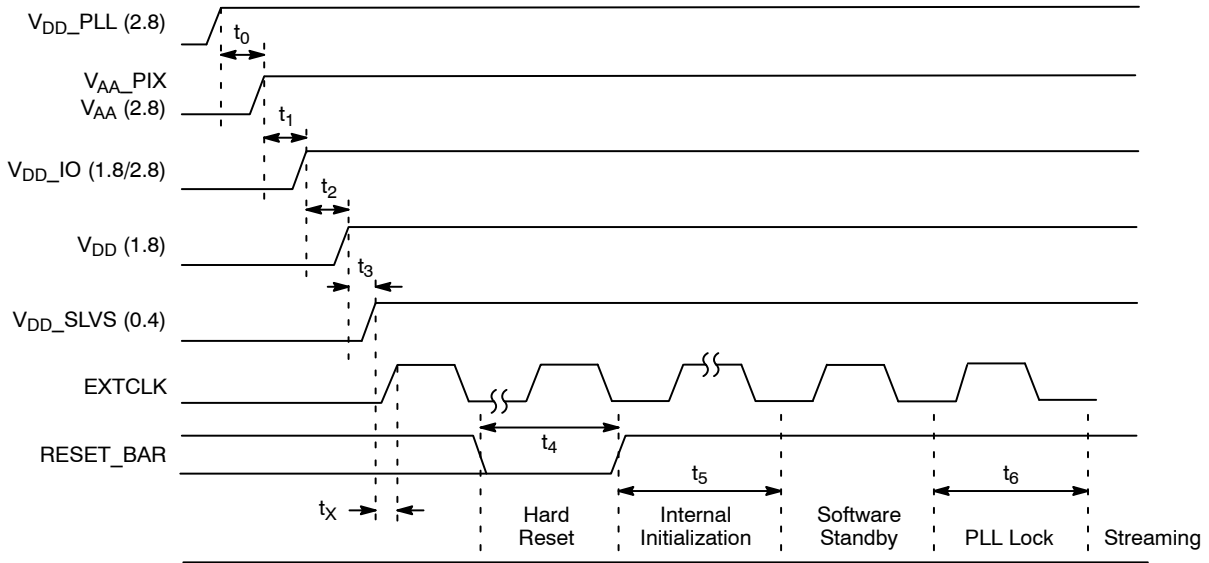

Figure 15. Power Up

Table 19. POWER-UP SEQUENCE

Definition	Symbol	Min	Typ	Max	Unit
VDD_PLL to VAA/VAA_PIX (Note 17)	t0	0	100	–	μ s
VAA/VAA_PIX to VDD_IO	t1	0	100	–	μ s
VDD_IO to VDD	t2	0	100	–	μ s
VDD to VDD_SLVS	t3	0	100	–	μ s
Xtal settle time	tx	–	30 (Note 15)	–	ms
Hard Reset	t4	1 (Note 16)	–	–	ms
Internal Initialization	t5	150000	–	–	EXTCLKs
PLL Lock Time	t6	1	–	–	ms

15. Xtal settling time is component-dependent, usually taking about 10 – 100 ms.

16. Hard reset time is the minimum time required after power rails are settled. In a circuit where Hard reset is held down by RC circuit, then the RC time must include the all power rail settle time and Xtal settle time.

17. It is critical that VDD_PLL is not powered up after the other power supplies. It must be powered before or at least at the same time as the others. If the case happens that VDD_PLL is powered after other supplies then sensor may have functionality issues and will experience high current draw on this supply.

POWER-DOWN SEQUENCE

The recommended power-down sequence for the AR0238 is shown in Figure 16. The available power supplies (VDD_IO, VDD, VDD_SLVS, VDD_PLL, VAA, VAA_PIX) must have the separation specified below.

1. Disable streaming if output is active by setting standby R0x301a[2] = 0

2. The soft standby state is reached after the current row or frame, depending on configuration, has ended.
3. Turn off VDD_SLVS.
4. Turn off VDD.
5. Turn off VDD_IO.
6. Turn off VAA/VAA_PIX.
7. Turn off VDD_PLL.

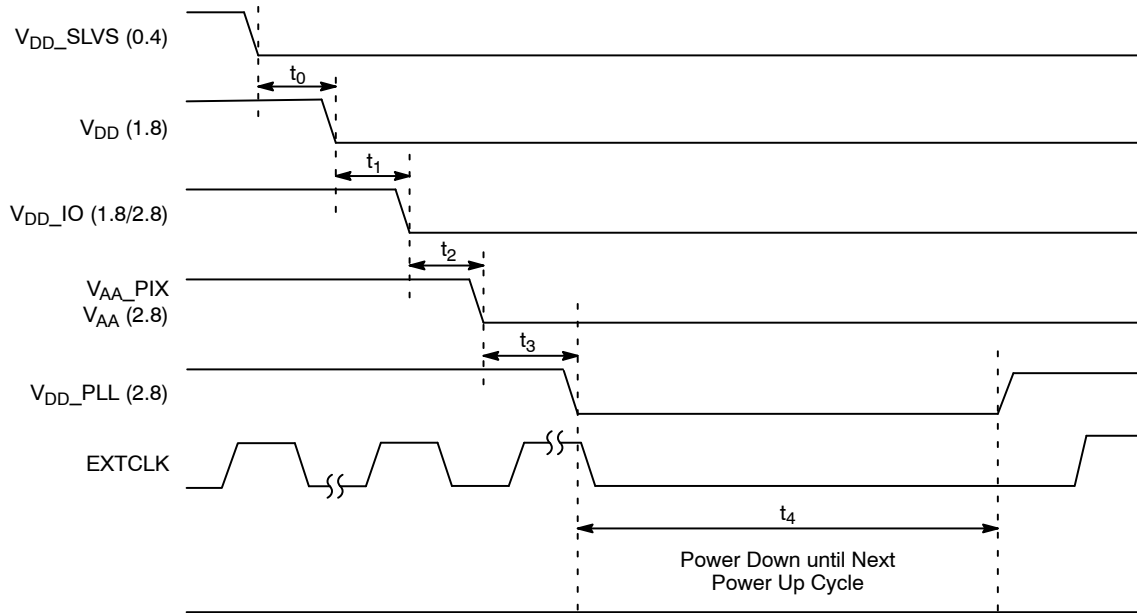

Figure 16. Power Down

Table 20. POWER-DOWN SEQUENCE

Definition	Symbol	Min	Typ	Max	Unit
VDD_SLVS to VDD	t0	0	–	–	μs
VDD to VDD_IO	t1	0	–	–	μs
VDD_IO to VAA/VAA_PIX	t2	0	–	–	μs
VAA/VAA_PIX to VDD_PLL	t3	0	–	–	μs
Power Down until Next Power Up Time	t4	100	–	–	ms

NOTE: t4 is required between power down and next power up time; all decoupling caps from regulators must be completely discharged.

MECHANICAL CASE OUTLINE PACKAGE DIMENSIONS

ON Semiconductor®



PLCC48 11.43x11.43 (HiSPi) CASE 776AQ ISSUE F

DATE 18 DEC 2019

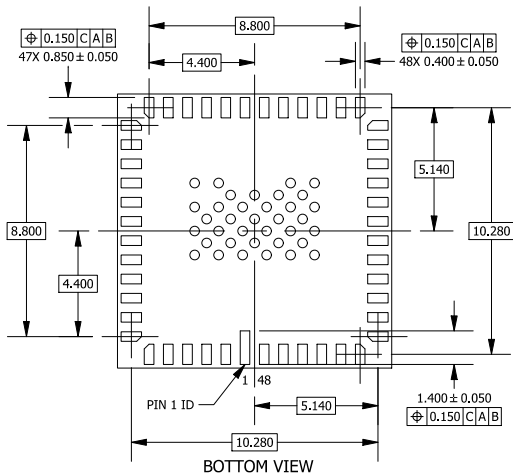
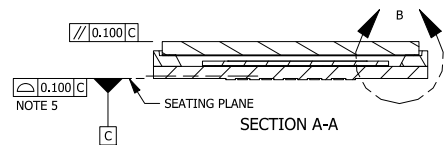
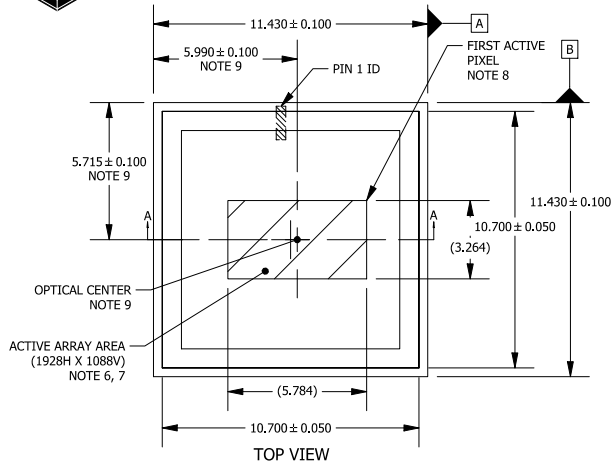
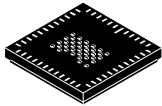

- NOTES:
1. DIMENSIONING AND TOLERANCING PER ASME Y14.5M, 1994.
 2. CONTROLLING DIMENSION: MILLIMETERS [mm].
 3. GLASS: 0.550 THICKNESS; REFRACTIVE INDEX = 1.52.
 4. AIR GAP BETWEEN GLASS AND PIXEL ARRAY: 0.260 THICKNESS.
 5. COPLANARITY APPLIES TO THE PLATED LAND PADS.
 6. PARALLELISM APPLIES ONLY TO THE ACTIVE ARRAY.
 7. MAXIMUM ROTATION OF ACTIVE ARRAY RELATIVE TO DATUMS A AND B IS ± 0.5°.
 8. REFER TO THE DEVICE DATA SHEET FOR TOTAL PIXEL ARRAY DEFINITIONS.
 9. OPTICAL CENTER RELATIVE TO PACKAGE CENTER (X, Y) = (0.275, 0.000).
 10. PACKAGE CENTER (X, Y) = (0.000, 0.000).

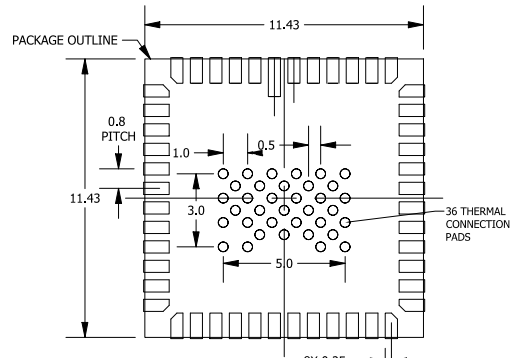
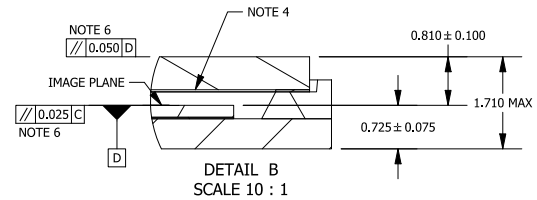

RECOMMENDED MOUNTING FOOTPRINT*

*FOR ADDITIONAL INFORMATION ON OUR Pb-FREE STRATEGY AND SOLDERING DETAILS, PLEASE DOWNLOAD THE ON SEMICONDUCTOR SOLDERING AND MOUNTING TECHNIQUES REFERENCE MANUAL, SOLDERRM/D.

GENERIC MARKING DIAGRAM*

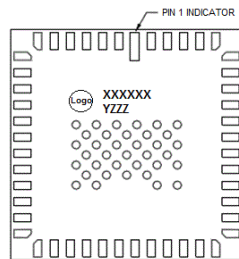

XXXX = Specific Device Code
Y = Year
ZZZ = Lot Traceability

*This information is generic. Please refer to device data sheet for actual part marking. Pb-Free indicator, "G" or microdot "▪", may or may not be present. Some products may not follow the Generic Marking.

DOCUMENT NUMBER:	98AON99907F	Electronic versions are uncontrolled except when accessed directly from the Document Repository. Printed versions are uncontrolled except when stamped "CONTROLLED COPY" in red.
DESCRIPTION:	PLCC48 11.43x11.43 (HiSPi)	PAGE 1 OF 1

ON Semiconductor and are trademarks of Semiconductor Components Industries, LLC dba ON Semiconductor or its subsidiaries in the United States and/or other countries. ON Semiconductor reserves the right to make changes without further notice to any products herein. ON Semiconductor makes no warranty, representation or guarantee regarding the suitability of its products for any particular purpose, nor does ON Semiconductor assume any liability arising out of the application or use of any product or circuit, and specifically disclaims any and all liability, including without limitation special, consequential or incidental damages. ON Semiconductor does not convey any license under its patent rights nor the rights of others.

MECHANICAL CASE OUTLINE PACKAGE DIMENSIONS

ON Semiconductor®

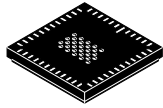

PLCC48 11.43x11.43 (Parallel) CASE 776AS ISSUE D

DATE 18 DEC 2019

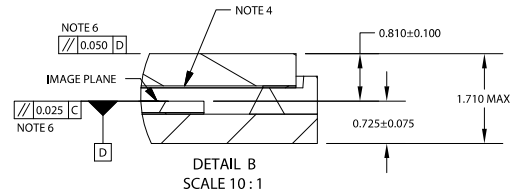
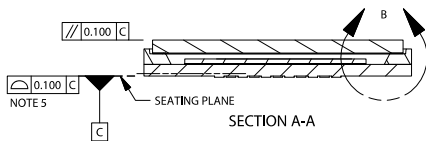
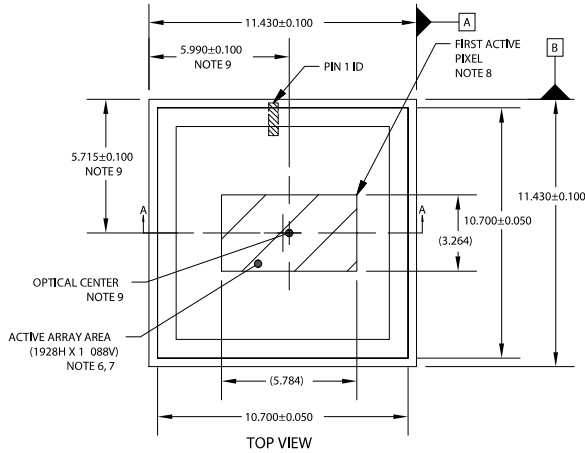

NOTES:

1. DIMENSIONING AND TOLERANCING PER ASME Y14.5M, 1994.
2. CONTROLLING DIMENSION: MILLIMETERS (mm).
3. GLASS: 0.550 THICKNESS; REFRACTIVE INDEX = 1.52.
4. AIR GAP BETWEEN GLASS AND PIXEL ARRAY: 0.260 THICKNESS.
5. COPLANARITY APPLIES TO THE PLATED LAND PADS.
6. PARALLELISM APPLIES ONLY TO THE ACTIVE ARRAY.
7. MAXIMUM ROTATION OF ACTIVE ARRAY RELATIVE TO DATUMS A AND B IS ± 0.5°.
8. REFER TO THE DEVICE DATA SHEET FOR TOTAL PIXEL ARRAY DEFINITION S.
9. OPTICAL CENTER RELATIVE TO PACKAGE CENTER (X, Y) = (0.275, 0.00 0).
10. PACKAGE CENTER (X, Y) = (0.000, 0.000).

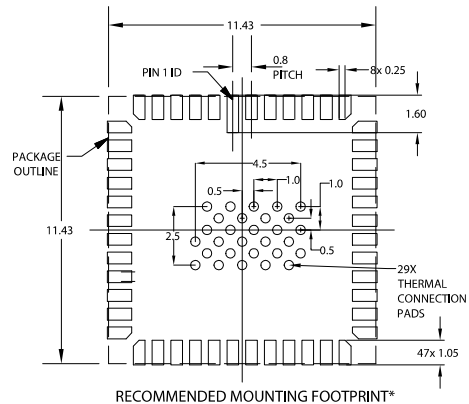
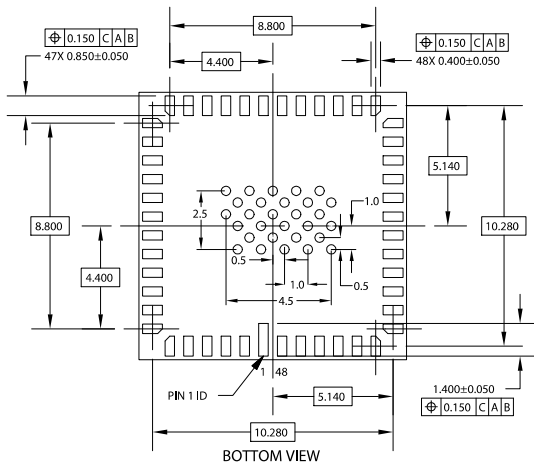

*FOR ADDITIONAL INFORMATION ON OUR Pb-FREE STRATEGY AND SOLDERING DETAILS, PLEASE DOWNLOAD THE ON SEMICONDUCTOR SOLDERING AND MOUNTING TECHNIQUES REFERENCE MANUAL, SOLDERRM.D.

GENERIC MARKING DIAGRAM*

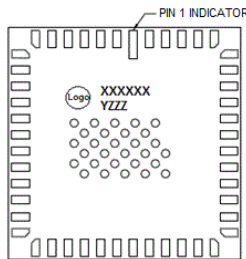

XXXX = Specific Device Code
Y = Year
ZZZ = Lot Traceability

*This information is generic. Please refer to device data sheet for actual part marking. Pb-Free indicator, "G" or microdot "•", may or may not be present. Some products may not follow the Generic Marking.

DOCUMENT NUMBER:	98AON12147G	Electronic versions are uncontrolled except when accessed directly from the Document Repository. Printed versions are uncontrolled except when stamped "CONTROLLED COPY" in red.
DESCRIPTION:	PLCC48 11.43x11.43 (Parallel)	PAGE 1 OF 1

ON Semiconductor and ON are trademarks of Semiconductor Components Industries, LLC dba ON Semiconductor or its subsidiaries in the United States and/or other countries. ON Semiconductor reserves the right to make changes without further notice to any products herein. ON Semiconductor makes no warranty, representation or guarantee regarding the suitability of its products for any particular purpose, nor does ON Semiconductor assume any liability arising out of the application or use of any product or circuit, and specifically disclaims any and all liability, including without limitation special, consequential or incidental damages. ON Semiconductor does not convey any license under its patent rights nor the rights of others.

ON Semiconductor and  are trademarks of Semiconductor Components Industries, LLC dba ON Semiconductor or its subsidiaries in the United States and/or other countries. ON Semiconductor owns the rights to a number of patents, trademarks, copyrights, trade secrets, and other intellectual property. A listing of ON Semiconductor's product/patent coverage may be accessed at www.onsemi.com/site/pdf/Patent-Marking.pdf. ON Semiconductor reserves the right to make changes without further notice to any products herein. ON Semiconductor makes no warranty, representation or guarantee regarding the suitability of its products for any particular purpose, nor does ON Semiconductor assume any liability arising out of the application or use of any product or circuit, and specifically disclaims any and all liability, including without limitation special, consequential or incidental damages. Buyer is responsible for its products and applications using ON Semiconductor products, including compliance with all laws, regulations and safety requirements or standards, regardless of any support or applications information provided by ON Semiconductor. "Typical" parameters which may be provided in ON Semiconductor data sheets and/or specifications can and do vary in different applications and actual performance may vary over time. All operating parameters, including "Typicals" must be validated for each customer application by customer's technical experts. ON Semiconductor does not convey any license under its patent rights nor the rights of others. ON Semiconductor products are not designed, intended, or authorized for use as a critical component in life support systems or any FDA Class 3 medical devices or medical devices with a same or similar classification in a foreign jurisdiction or any devices intended for implantation in the human body. Should Buyer purchase or use ON Semiconductor products for any such unintended or unauthorized application, Buyer shall indemnify and hold ON Semiconductor and its officers, employees, subsidiaries, affiliates, and distributors harmless against all claims, costs, damages, and expenses, and reasonable attorney fees arising out of, directly or indirectly, any claim of personal injury or death associated with such unintended or unauthorized use, even if such claim alleges that ON Semiconductor was negligent regarding the design or manufacture of the part. ON Semiconductor is an Equal Opportunity/Affirmative Action Employer. This literature is subject to all applicable copyright laws and is not for resale in any manner.

PUBLICATION ORDERING INFORMATION

LITERATURE FULFILLMENT:

Email Requests to: orderlit@onsemi.com

ON Semiconductor Website: www.onsemi.com

TECHNICAL SUPPORT

North American Technical Support:
Voice Mail: 1 800-282-9855 Toll Free USA/Canada
Phone: 011 421 33 790 2910

Europe, Middle East and Africa Technical Support:

Phone: 00421 33 790 2910

For additional information, please contact your local Sales Representative