

**DATA SHEET**

# SKY67130-396LF: 0.7-2.7 GHz High Linearity Amplifier Driver

## Applications

- LTE, CDMA, WCDMA, and TD-SCDMA cellular infrastructures
- Linear amplifier systems that require high OIP3 with extremely low current
- Ideal for 2.7 to 5.0 V WLAN driver PAs and cellular repeater systems

## Features

- Ultra efficient linear performance
- High OIP3 performance at 2600 MHz: +39 dBm with 3.3 V and 22 mA
- Low Noise Figure: 2.6 dB @ 2.6 GHz and 22 mA
- Adjustable supply current
- Power-down capability
- Unconditionally stable to 24 GHz
- Temperature and process-stable active bias
- Miniature DFN (8-pin, 2 x 2 mm) package (MSL1 @ 260 °C per JEDEC J-STD-020)



Skyworks Green™ products are compliant with all applicable legislation and are halogen-free. For additional information, refer to *Skyworks Definition of Green™*, document number SQ04-0074.

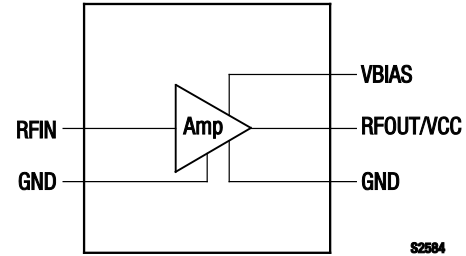

**Figure 1. SKY67130-396LF Block Diagram**

## Description

The SKY67130-396LF is an InGaP HBT linear amplifier driver with an active bias and superior low-current performance. The advanced InGaP HBT process provides excellent return loss, low noise, and high linearity. The internal active bias circuitry provides stable performance over temperature and process variation.

The supply current can be adjusted, independent of the supply voltage, using the VBIAS signal (pin 8). The VBIAS pin should be connected to the control voltage through an external resistor to control the collector current. The RFIN and RFOUT/VCC pins should be DC blocked to ensure proper operation.

The SKY67130-396LF is manufactured in a compact, 2 x 2 mm, 8-pin Dual Flat No-Lead (DFN) package. A functional block diagram is shown in Figure 1. The pin configuration and package are shown in Figure 2. Signal pin assignments and functional pin descriptions are provided in Table 1.

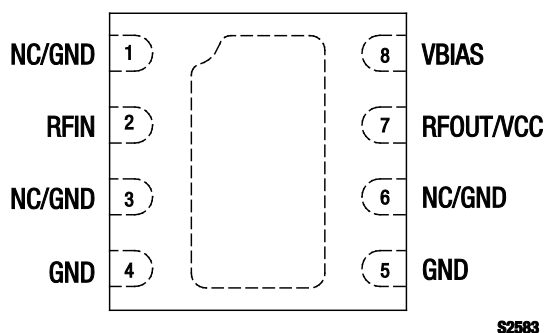

**Figure 2. SKY67130-396LF Pinout – 8-Pin DFN (Top View)**

**Table 1. SKY67130-396LF Signal Descriptions**

Pin #	Name	Description	Pin #	Name	Description
1	NC or GND	No connection. May be connected to ground with no change in performance.	5	GND	Connect to ground through a low impedance path.
2	RFIN	RF input. DC blocking capacitor required.	6	NC or GND	No connection required. May be connected to ground with no change in performance.
3	NC or GND	No connection. May be connected to ground with no change in performance.	7	RFOUT/VCC	RF output. Apply VCC through RF choke inductor. No DC blocking capacitor required.
4	GND	Connect to ground through a low impedance path.	8	VBIAS	Sets LNA quiescent current

**Table 2. SKY67130-396LF Absolute Maximum Ratings (Note 1)**

Parameter	Symbol	Minimum	Typical	Maximum	Units
Supply voltage	V <sub>CC</sub>			5.5	V
Quiescent current	I <sub>CO</sub>			45	mA
Dissipated power (Note 2)	P <sub>DISS</sub>			150	mW
RF input power	P <sub>IN</sub>			+20	dBm
Storage temperature	T <sub>STG</sub>	-65	+25	+150	°C
Operating temperature	T <sub>A</sub>	-40	+25	+85	°C
Junction temperature	T <sub>J</sub>			+150	°C

**Note:** Exposure to maximum rating conditions for extended periods may reduce device reliability. There is no damage to device with only one parameter set at the limit and all other parameters set at or below their nominal value. Exceeding any of the limits listed here may result in permanent damage to the device.

**Note 2:** Dissipated power is equal to supply voltage (V<sub>CC</sub>) multiplied by the quiescent current (I<sub>CO</sub>).

---

**CAUTION:** Although this device is designed to be as robust as possible, Electrostatic Discharge (ESD) can damage this device. This device must be protected at all times from ESD. Static charges may easily produce potentials of several kilovolts on the human body or equipment, which can discharge without detection. Industry-standard ESD precautions should be used at all times. The SKY67130-396LF is a Human Body Model (HBM) Class 1A ESD device.

---

## Electrical and Mechanical Specifications

The absolute maximum ratings of the SKY67130-396LF are provided in Table 2. Electrical specifications are provided in Tables 3 and 4.

Typical performance characteristics of the SKY67130-396LF are illustrated in Figures 3 through 27.

**Table 3. SKY67130-396LF Electrical Specifications: 3.3 V Operation (Note 1)**  
**(V<sub>CC</sub> = 3.3 V, I<sub>CO</sub> = 22 mA, T<sub>A</sub> = +25 °C, P<sub>IN</sub> = -13 dBm, Characteristic Impedance [Z<sub>0</sub>] = 50 Ω, Unless Otherwise Noted)**

Parameter	Symbol	Test Condition	Min	Typical	Max	Units
<b>RF Specifications</b>						
Noise Figure (Note 2)	NF	@ 2.6 GHz, quiescent current = 22 mA		2.6		dB
Small signal gain	IS21I	@ 2.6 GHz		13		dB
Input return loss	IS11I	@ 2.6 GHz		15		dB
Output return loss	IS22I	@ 2.6 GHz		25		dB
Reverse isolation	IS12I	@ 2.6 GHz		19		dB
3 <sup>rd</sup> Order Input Intercept Point	IIP3	@ 2.6 GHz, Δf = ±1 MHz, P <sub>IN</sub> = -14 dBm/tone		+26		dBm
3 <sup>rd</sup> Order Output Intercept Point	OIP3	@ 2.6 GHz, Δf = ±1 MHz, P <sub>IN</sub> = -14 dBm/tone		+39		dBm
1 dB Input Compression Point	IP1dB	@ 2.6 GHz		+4		dBm
1 dB Output Compression Point	OP1dB	@ 2.6 GHz		+16		dBm
<b>DC Specifications</b>						
Supply voltage	V <sub>CC</sub>			3.3		V
Quiescent current	I <sub>CO</sub>	Set with external resistor in series with VBIAS		22		mA
Maximum junction temperature (+85 °C heat sink temperature)	T <sub>JMAX</sub>	3.3 V and 22 mA quiescent current		103		°C
Thermal resistance	θ <sub>JC</sub>			250		°C/W

**Note 1:** Performance is guaranteed only under the conditions listed in this Table.

**Note 2:** Board and connector losses have not been de-embedded.

**Table 4. SKY67130-396LF Electrical Specifications: 5.0 V Operation (1 of 2) (Note 1)**  
**(V<sub>CC</sub> = 5.0 V, I<sub>CO</sub> = 22 mA, T<sub>A</sub> = +25 °C, P<sub>IN</sub> = -13 dBm, Characteristic Impedance [Z<sub>0</sub>] = 50 Ω, Unless Otherwise Noted)**

Parameter	Symbol	Test Condition	Min	Typical	Max	Units
<b>RF Specifications</b>						
Noise Figure (Note 2)	NF	@ 2.6 GHz		2.6		dB
Small signal gain	IS21I	@ 2.6 GHz		13		dB
Input return loss	IS11I	@ 2.6 GHz		15		dB
Output return loss	IS22I	@ 2.6 GHz		20		dB
Reverse isolation	IS12I	@ 2.6 GHz		19		dB
3 <sup>rd</sup> Order Input Intercept Point	IIP3	@ 2.6 GHz, Δf = ±1 MHz, P <sub>IN</sub> = -14 dBm/tone		+24		dBm
3 <sup>rd</sup> Order Output Intercept Point	OIP3	@ 2.6 GHz, Δf = ±1 MHz, P <sub>IN</sub> = -14 dBm/tone		+37		dBm
1 dB Input Compression Point	IP1dB	@ 2.6 GHz		+7		dBm
1 dB Output Compression Point	OP1dB	@ 2.6 GHz		+19		dBm

**Table 4. SKY67130-396LF Electrical Specifications: 5.0 V Operation (2 of 2) (Note 1)**  
**(V<sub>CC</sub> = 5.0 V, I<sub>CC</sub> = 22 mA, T<sub>A</sub> = +25 °C, P<sub>IN</sub> = -13 dBm, Characteristic Impedance [Z<sub>0</sub>] = 50 Ω, Unless Otherwise Noted)**

Parameter	Symbol	Test Condition	Min	Typical	Max	Units
<b>DC Specifications</b>						
Supply voltage	V <sub>CC</sub>			5.0		V
Quiescent current	I <sub>CC</sub>	Set with external resistor in series with VBIAS		22		mA
Maximum junction temperature (+85 °C heat sink temperature)	T <sub>JMAX</sub>	5.0 V and 22 mA quiescent current		113		°C
Thermal resistance	θ <sub>JC</sub>			250		°C/W

**Note 1:** Performance is guaranteed only under the conditions listed in this Table.

**Note 2:** Board and connector losses have not been de-embedded.

### Typical Performance Characteristics

**(V<sub>CC</sub> = 3.3 V, I<sub>CC</sub> = 22 mA, f = 2.5 to 2.7 GHz, Standard Evaluation Board Matching, Characteristic Impedance [Z<sub>0</sub>] = 50 Ω, Unless Otherwise Noted)**

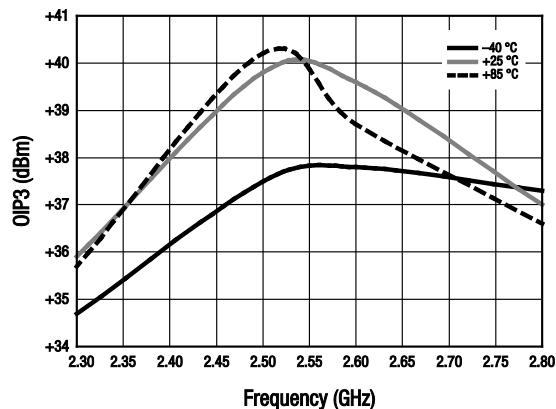

**Figure 3. OIP3 vs Frequency Over Temperature**

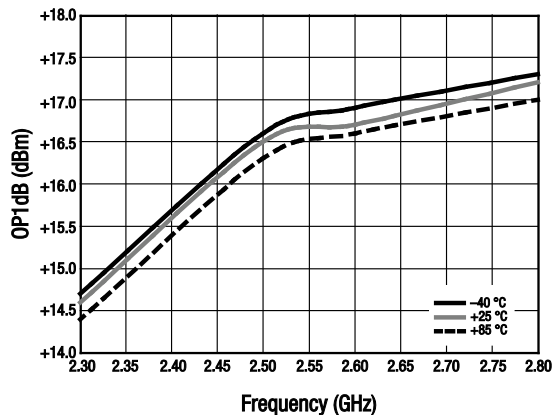

**Figure 4. OP1 dB vs Frequency Over Temperature**

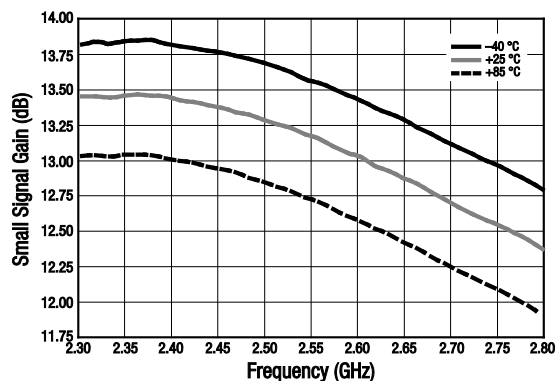

**Figure 5. Small Signal Gain (Narrow Band) vs Frequency Over Temperature**

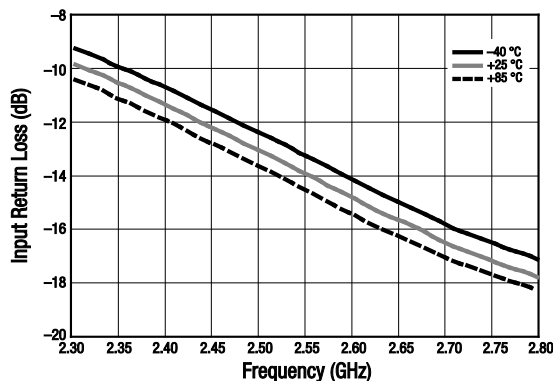

**Figure 6. Input Return Loss vs Frequency (Narrow Band) Over Temperature**

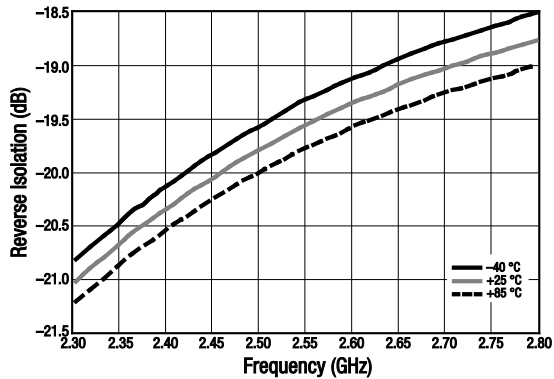

Figure 7. Reverse Isolation vs Frequency (Narrow Band) Over Temperature

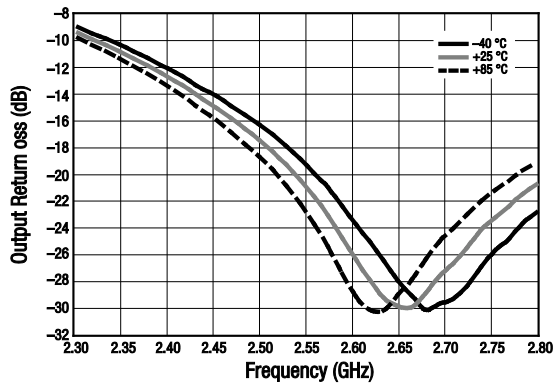

Figure 8. Output Return Loss vs Frequency (Narrow Band) Over Temperature

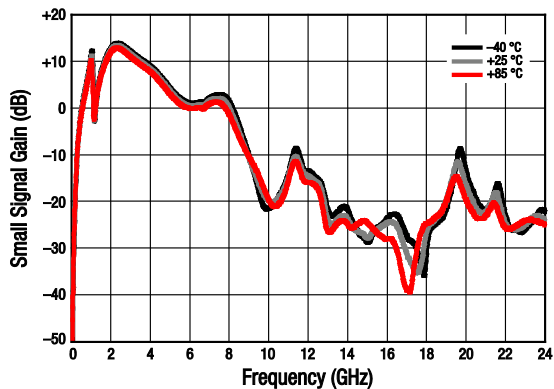

Figure 9. Small Signal Gain vs Frequency (Wide Band) Over Temperature

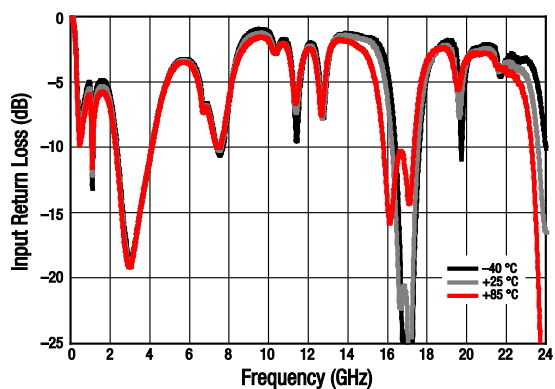

Figure 10. Input Return Loss vs Frequency (Wide Band) Over Temperature

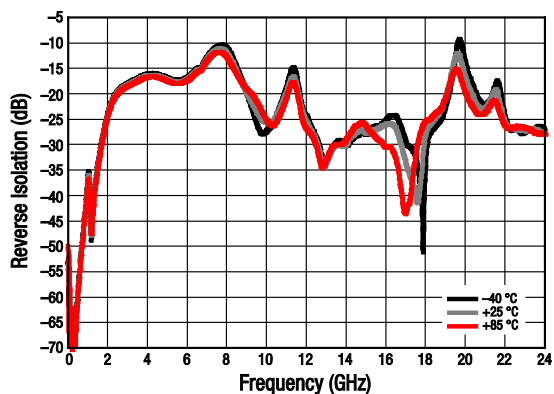

Figure 11. Reverse Isolation vs Frequency (Wide Band) Over Temperature

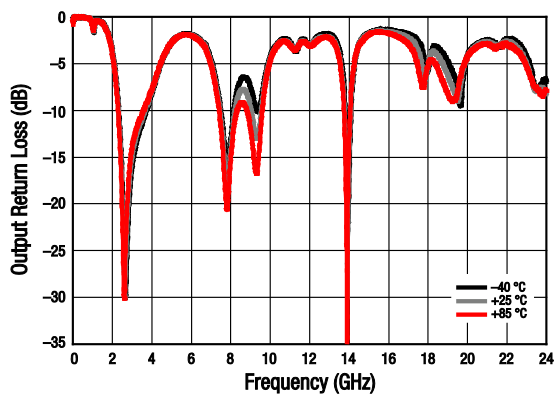

Figure 12. Output Return Loss vs Frequency (Wide Band) Over Temperature

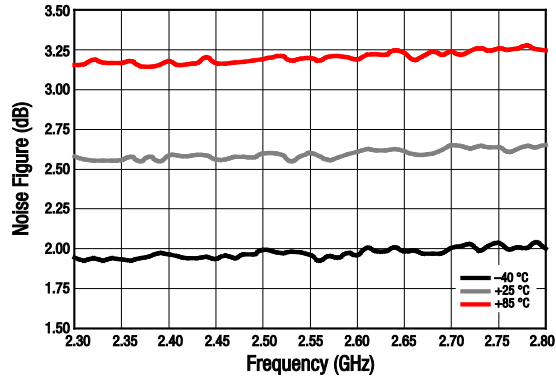

Figure 13. Noise Figure vs Frequency Over Temperature (Includes EVB Losses)

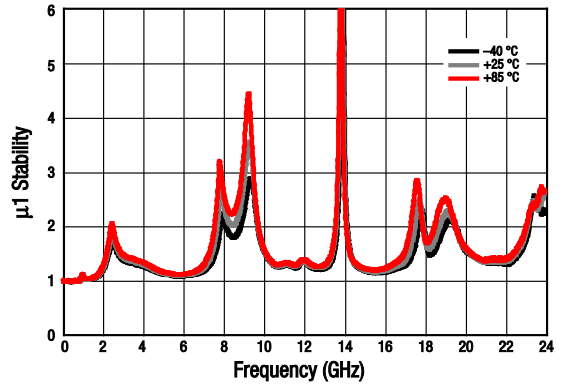
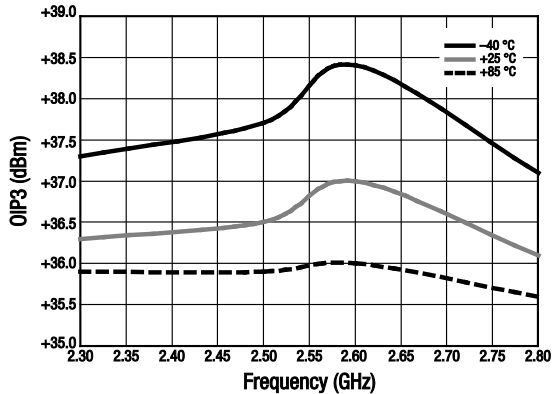

Figure 14.  $\mu_1$  Stability vs Frequency Over Temperature

**Typical Performance Characteristics**

(VBIAS = 5.0 V, Icc = 22 mA, f = 2.5 to 2.7 GHz, Standard Evaluation Board Matching, Characteristic Impedance [Zo] = 50 Ω, Unless Otherwise Noted)



**Figure 15. OIP3 vs Frequency Over Temperature**

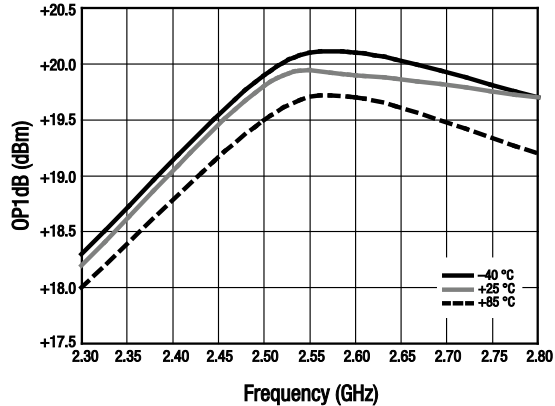

**Figure 16. OP1dB vs Frequency Over Temperature**

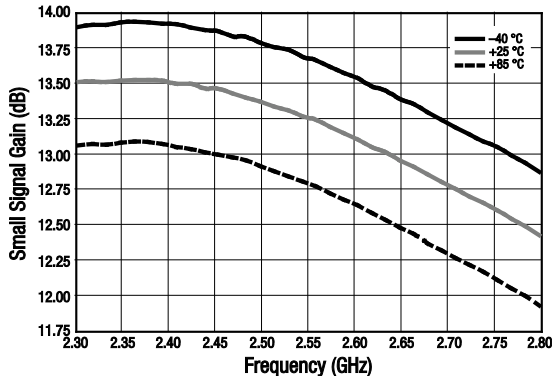

**Figure 17. Small Signal Gain vs Frequency (Narrow Band) Over Temperature**

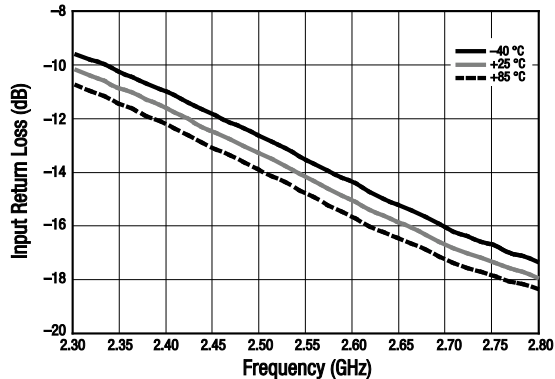

**Figure 18. Input Return Loss vs Frequency (Narrow Band) Over Temperature**

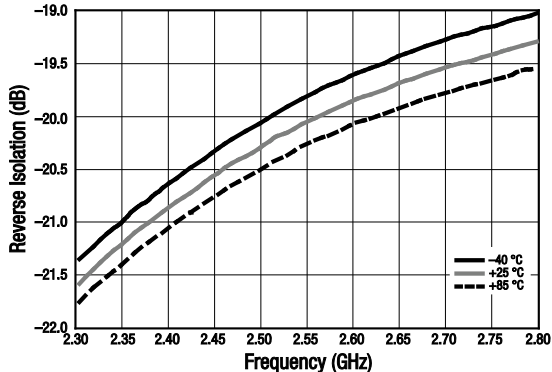

**Figure 19. Reverse Isolation vs Frequency (Narrow Band) Over Temperature**

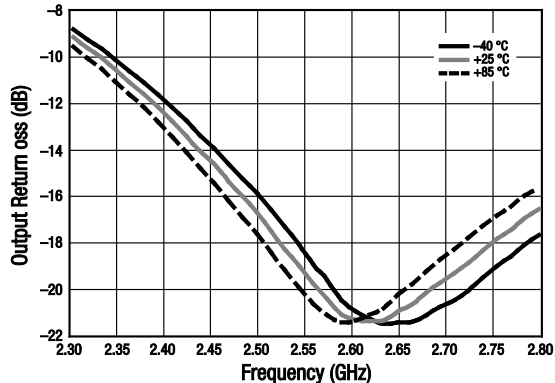

**Figure 20. Output Return Loss vs Frequency (Narrow Band) Over Temperature**

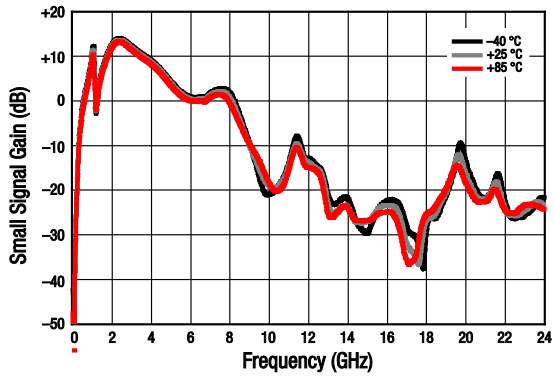

Figure 21. Small Signal Gain vs Frequency (Wide Band) Over Temperature

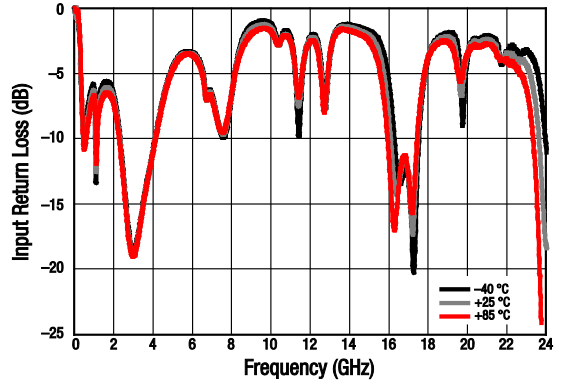

Figure 22. Input Return Loss vs Frequency (Wide Band) Over Temperature

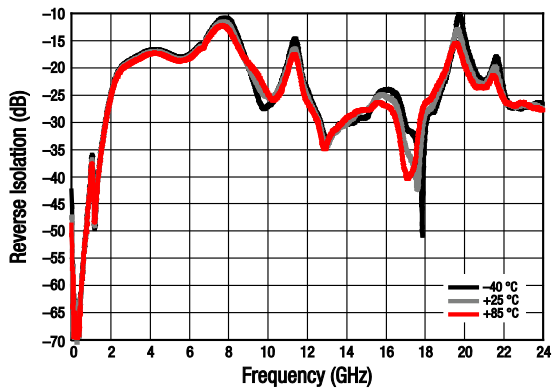

Figure 23. Reverse Isolation vs Frequency (Wide Band) Over Temperature

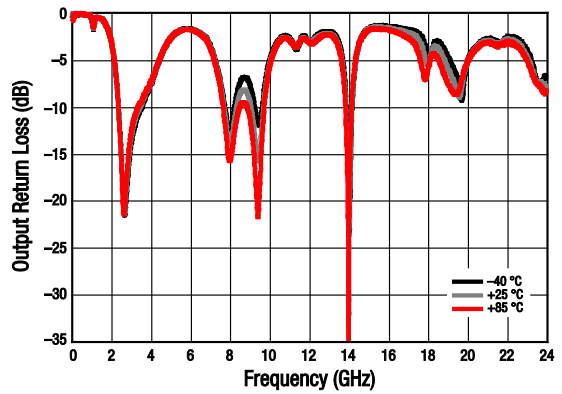

Figure 24. Output Return Loss vs Frequency (Wide Band) Over Temperature

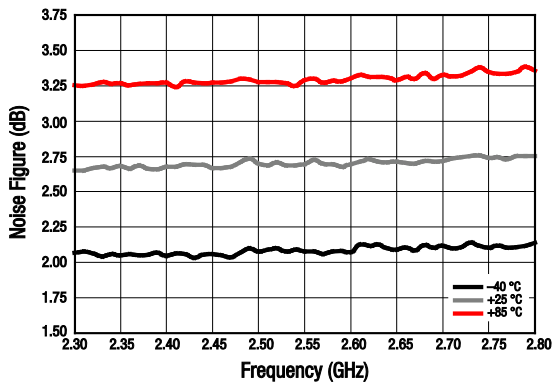

Figure 25. Noise Figure vs Frequency Over Temperature (Includes EVB Losses)

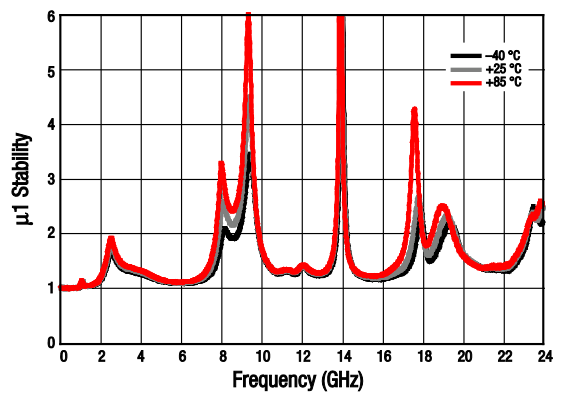
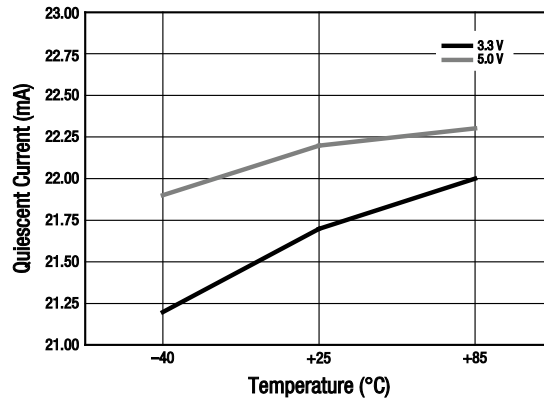

Figure 26.  $\mu_1$  Stability vs Frequency Over Temperature





**Figure 27. Quiescent Current vs Temperature Over Voltage**

### Evaluation Board Description

The SKY67130-396LF Evaluation Board is used to test the performance of the SKY67130-396LF LNA. An assembly drawing for the Evaluation Board is shown in Figure 28. An Evaluation Board schematic diagram is provided in Figure 29. Table 5 provides the Bill of Materials (BOM) list for Evaluation Board 2.6 GHz matching components.

The test board uses a 10 mil Rogers 4350B substrate on a 50 mil FR4 supporting substrate. The Rogers 4350B material was selected for the RF circuit because of its low dielectric constant ( $\epsilon_r$ ) and low  $\epsilon_r$  variation over temperature for the best possible noise performance.

### Package Dimensions

The PCB layout footprint for the SKY67130-396LF is provided in Figure 30. Typical case markings are shown in Figure 31. Package dimensions for the 8-pin DFN are shown in Figure 32, and tape and reel dimensions are provided in Figure 33.

### Package and Handling Information

Instructions on the shipping container label regarding exposure to moisture after the container seal is broken must be followed. Otherwise, problems related to moisture absorption may occur when the part is subjected to high temperature during solder assembly.

THE SKY67130-396LF is rated to Moisture Sensitivity Level 1 (MSL1) at 260 °C. It can be used for lead or lead-free soldering. For additional information, refer to the Skyworks Application Note, *Solder Reflow Information*, document number 200164.

Care must be taken when attaching this product, whether it is done manually or in a production solder reflow environment. Production quantities of this product are shipped in a standard tape and reel format.

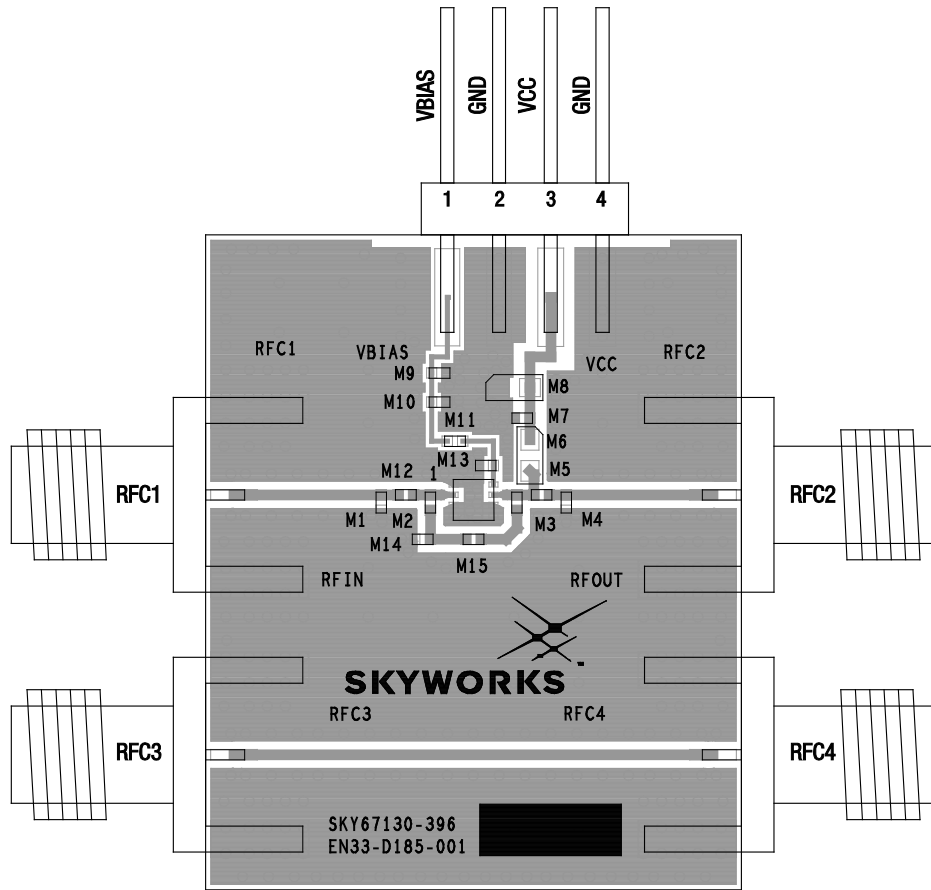

Figure 28. SKY67130-396LF Evaluation Board Assembly Diagram

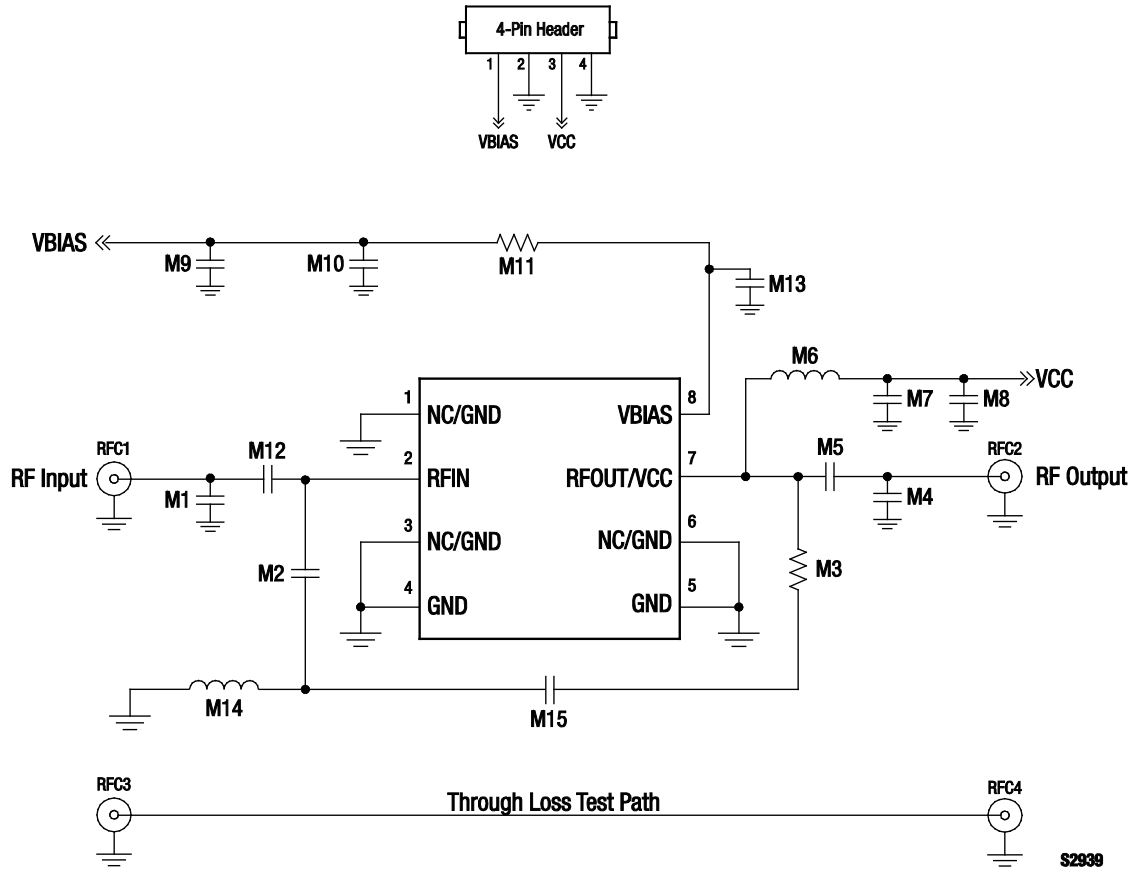

Figure 29. SKY67130-396LF Evaluation Board Schematic

Table 5. SKY67130-396LF Evaluation Board Bill of Materials: 2.5 to 2.7 GHz Matching Components

Component	Value	Size	Manufacturer
M1	DNI	0402	–
M2	0.1 $\mu$ F	0402	Murata GRM
M3	DNI	0402	–
M4	DNI	0402	–
M5	1.2 pF	0402	Murata GJM
M6	1.8 nH	0402	Murata LQG
M7	22 pF	0402	Murata GRM
M8	1 $\mu$ F	0402	Murata GRM
M9	1 $\mu$ F	0402	Murata GRM
M10	100 pF	0402	Murata GRM
M11	360 $\Omega$	0402	Kamaya RMC 1/16S 5%
M12	8.2 pF	0402	Murata GJM
M13	DNI	0402	–
M14	8.2 nH	0402	Murata LQG
M15	DNI	0402	–

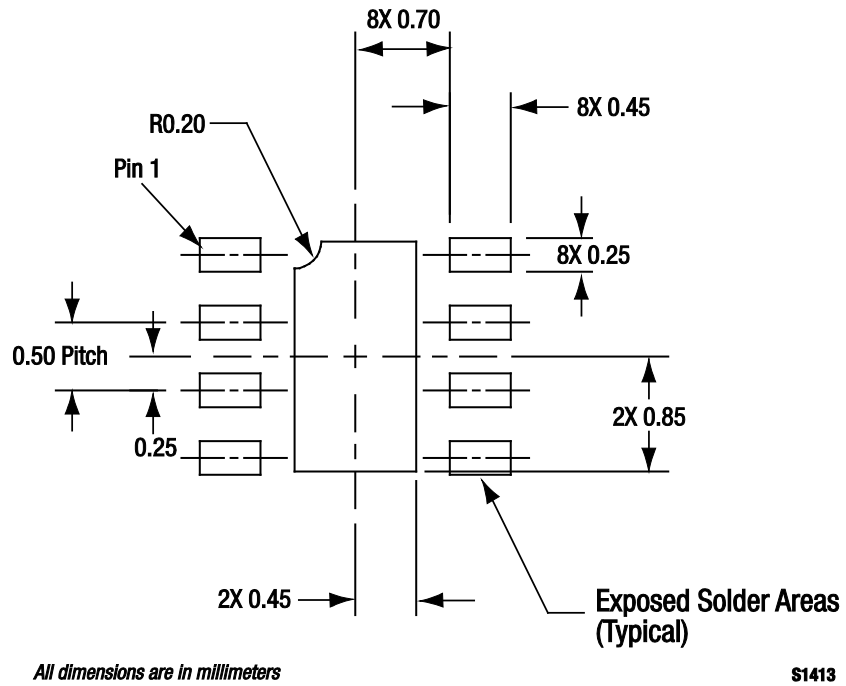

Figure 30. SKY67130-396LF PCB Layout Footprint (Top View)

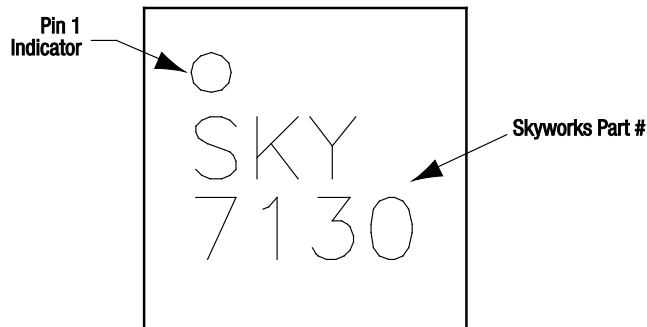
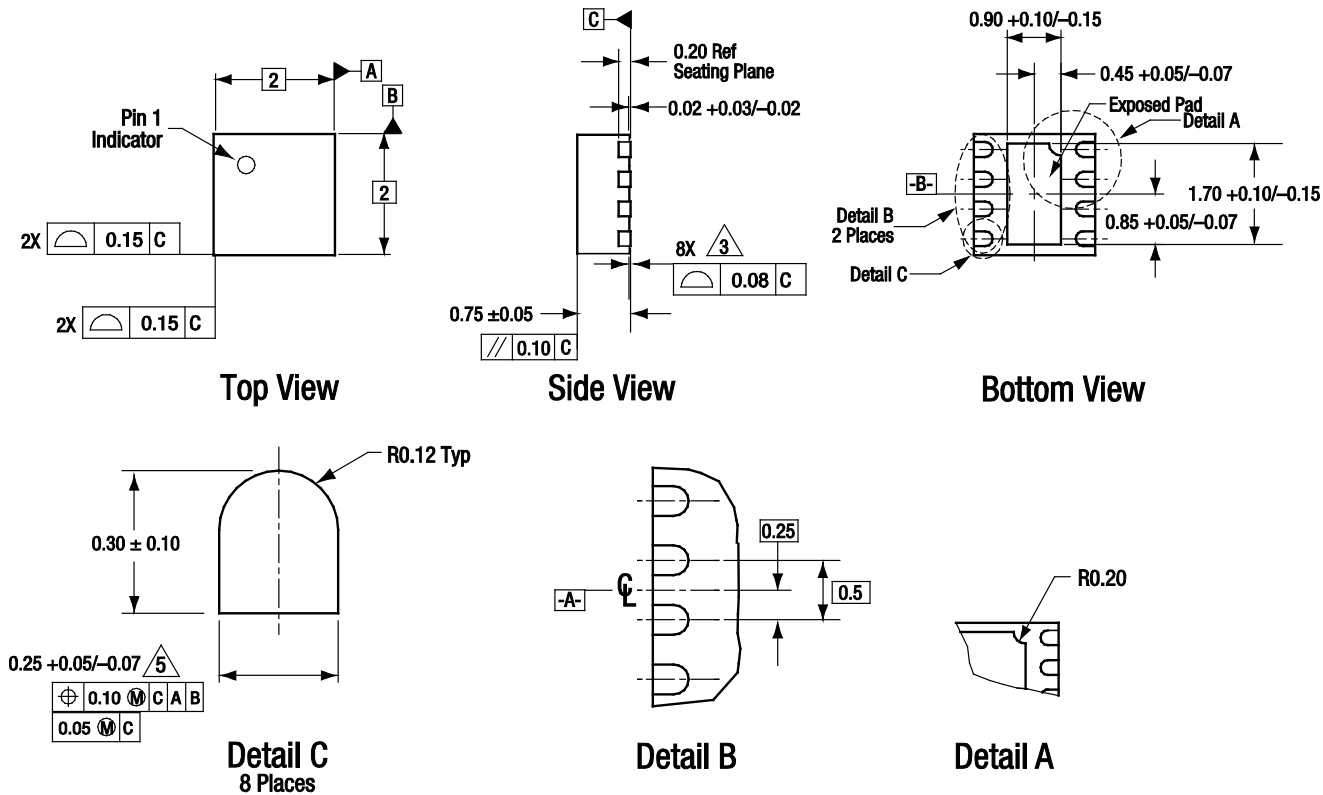

Figure 31. Typical Case Markings (Top View)



All measurements are in millimeters.  
 Dimensioning and tolerancing according to ASME Y14.5M-1994.  
 Coplanarity applies to the exposed heat sink slug as well as the terminals.  
 Plating requirement per source control drawing (SCD) 2504.  
 Dimension applies to metallized terminal and is measured between 0.15 mm and 0.30 mm from terminal tip.

S1945

Figure 32. SKY67130-396LF 8-Pin DFN Package Dimensions

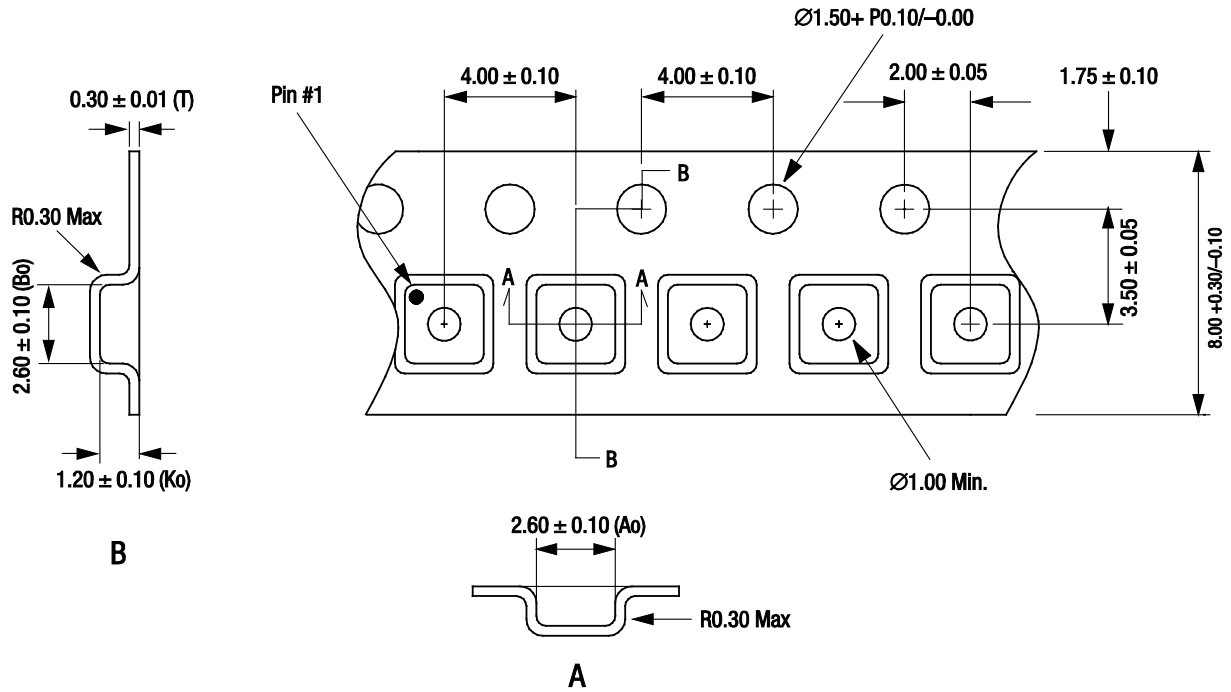

- Notes:
1. Carrier tape: black conductive polystyrene.
  2. Cover tape material: transparent conductive HSA.
  3. Cover tape size: 5.40 mm width.
  4. All measurements are in millimeters.

S1480

Figure 33. SKY67130-396LF Tape and Reel Dimensions

**Ordering Information**

Model Name	Manufacturing Part Number	Evaluation Board Part Number
SKY67130-396LF LNA	SKY67130-396LF	SKY67130-396LF-EVB

Copyright © 2012 Skyworks Solutions, Inc. All Rights Reserved.

Information in this document is provided in connection with Skyworks Solutions, Inc. ("Skyworks") products or services. These materials, including the information contained herein, are provided by Skyworks as a service to its customers and may be used for informational purposes only by the customer. Skyworks assumes no responsibility for errors or omissions in these materials or the information contained herein. Skyworks may change its documentation, products, services, specifications or product descriptions at any time, without notice. Skyworks makes no commitment to update the materials or information and shall have no responsibility whatsoever for conflicts, incompatibilities, or other difficulties arising from any future changes.

No license, whether express, implied, by estoppel or otherwise, is granted to any intellectual property rights by this document. Skyworks assumes no liability for any materials, products or information provided hereunder, including the sale, distribution, reproduction or use of Skyworks products, information or materials, except as may be provided in Skyworks Terms and Conditions of Sale.

THE MATERIALS, PRODUCTS AND INFORMATION ARE PROVIDED "AS IS" WITHOUT WARRANTY OF ANY KIND, WHETHER EXPRESS, IMPLIED, STATUTORY, OR OTHERWISE, INCLUDING FITNESS FOR A PARTICULAR PURPOSE OR USE, MERCHANTABILITY, PERFORMANCE, QUALITY OR NON-INFRINGEMENT OF ANY INTELLECTUAL PROPERTY RIGHT; ALL SUCH WARRANTIES ARE HEREBY EXPRESSLY DISCLAIMED. SKYWORKS DOES NOT WARRANT THE ACCURACY OR COMPLETENESS OF THE INFORMATION, TEXT, GRAPHICS OR OTHER ITEMS CONTAINED WITHIN THESE MATERIALS. SKYWORKS SHALL NOT BE LIABLE FOR ANY DAMAGES, INCLUDING BUT NOT LIMITED TO ANY SPECIAL, INDIRECT, INCIDENTAL, STATUTORY, OR CONSEQUENTIAL DAMAGES, INCLUDING WITHOUT LIMITATION, LOST REVENUES OR LOST PROFITS THAT MAY RESULT FROM THE USE OF THE MATERIALS OR INFORMATION, WHETHER OR NOT THE RECIPIENT OF MATERIALS HAS BEEN ADVISED OF THE POSSIBILITY OF SUCH DAMAGE.

Skyworks products are not intended for use in medical, lifesaving or life-sustaining applications, or other equipment in which the failure of the Skyworks products could lead to personal injury, death, physical or environmental damage. Skyworks customers using or selling Skyworks products for use in such applications do so at their own risk and agree to fully indemnify Skyworks for any damages resulting from such improper use or sale.

Customers are responsible for their products and applications using Skyworks products, which may deviate from published specifications as a result of design defects, errors, or operation of products outside of published parameters or design specifications. Customers should include design and operating safeguards to minimize these and other risks. Skyworks assumes no liability for applications assistance, customer product design, or damage to any equipment resulting from the use of Skyworks products outside of stated published specifications or parameters.

Skyworks, the Skyworks symbol, and "Breakthrough Simplicity" are trademarks or registered trademarks of Skyworks Solutions, Inc., in the United States and other countries. Third-party brands and names are for identification purposes only, and are the property of their respective owners. Additional information, including relevant terms and conditions, posted at [www.skyworksinc.com](http://www.skyworksinc.com), are incorporated by reference.