

# LTC7802, LTC7802-3.3 Dual 5V-36V<sub>IN</sub>, 3.3V/20A and 5V/15A Output Synchronous Buck Converter with Spread Spectrum

## DESCRIPTION

Demonstration circuit 2922A-A and 2922A-B are dual step-down DC/DC converters featuring the [LTC®7802](#) or [LTC7802-3.3](#) PWM controllers. Both controller IC's used on these demo boards are 40V Low I<sub>Q</sub>, Dual, 2-Phase Synchronous Step-Down Controllers with Spread Spectrum. And both demo boards operate over a 5V to 36V input voltage range and provide a 3.3V at 20A and 5V at 15A outputs.

The DC2922A-A uses the LTC7802 and has a resistor divider network to set the 3.3V output. The DC2922A-B uses the LTC7802-3.3 and has a fixed 3.3V output that does not require the resistor divider network.

Some of the key features of both boards include a FREQUENCY jumper for spread-spectrum or external

clock option, and EXT<sub>V<sub>CC</sub></sub> jumper for V<sub>OUT2</sub>, EXT<sub>V<sub>CC</sub></sub>, or input derived V<sub>CC</sub>, a MODE jumper that allows the converter to run in FCM, pulse-skipping, or Burst Mode® operation and PGOOD signals for each output.

The two channels can be paralleled for higher output current. See the respective data sheets for more information on setting-up the board for paralleling both outputs. The LTC7802 and LTC7802-3.3 data sheets give a complete description of these devices, their operation and application information, and must be read in conjunction with this demo manual prior to working on or modifying these demo circuits.

**[Design files for this circuit board are available.](#)**

All registered trademarks and trademarks are the property of their respective owners.

## PERFORMANCE SUMMARY Specifications are at T<sub>A</sub> = 25°C

### DC2922A-A & DC2922A-B

SYMBOL	PARAMETER	CONDITIONS	MIN	TYP	MAX	UNITS
V <sub>IN</sub>	Input Supply Range		5		36	V
F <sub>SW</sub>	Switching Frequency			350		kHz
V <sub>OUT1</sub>	Output Voltage		3.28	3.33	3.38	V
I <sub>OUT1</sub>	Maximum Output Current	V <sub>IN</sub> = 5.5V	20			A
V <sub>OUT1</sub> (AC)	Output Ripple (Across COUT3)	V <sub>IN</sub> = 24V, I <sub>OUT</sub> = 4A		50		mVp-p
V <sub>OUT2</sub>	Output Voltage		4.92	5.00	5.08	V
I <sub>OUT2</sub>	Maximum Output Current	V <sub>IN</sub> = 5.5V	15			A
V <sub>OUT2</sub> (AC)	Output Ripple (Across COUT6)	V <sub>IN</sub> = 24V, I <sub>OUT</sub> = 4A		40		mVp-p
η	Efficiency	V <sub>IN</sub> = 12V, I <sub>OUT1</sub> = 20A, I <sub>OUT2</sub> = 15A		94.7		%

# DEMO MANUAL

## DC2922A-A/DC2922A-B

### BOARD PHOTO



### QUICK START PROCEDURE

Demo circuit 2922A is an easy way to evaluate the performance of the LTC7802. Refer to Figure 1 for proper measurement equipment setup, and follow the procedure below:

1. With power off, connect the input power supply “+” to  $V_{IN}$  and “-” to GND. Connect the loads from  $V_{OUT1}$  to GND, and  $V_{OUT2}$  to GND.

2. Set voltage of the DC power supply at 6V. Turn on the power at the input.

Note: Make sure that the input voltage does not exceed 36V.

3. Check for the proper output voltage between  $V_{OUT1}$  and GND ( $V_{OUT1} = 3.3V$ ). Check for the proper output voltage between  $V_{OUT2}$  and GND ( $V_{OUT2} = 5V$ ).

Note: If there is no output, or output voltage value is out of the spec, temporarily disconnect the load to make sure that the load is not set too high.

Note: The circuit features frequency foldback to protect the power switches during a fault or output current overload.

4. Once the proper output voltage at each channel is established, adjust the load within the operating range and measure the output voltage regulation, ripple voltage, efficiency and other parameters.

Note: When measuring the input or output voltage ripple, care must be taken to avoid a long ground lead on the oscilloscope probe. Measure the input or output voltage ripple by touching the probe tip directly across the  $V_{IN1}$  and GND terminals,  $V_{OUT1}$  and GND terminals, or  $V_{OUT2}$  and GND terminals. See Figure 2 for proper scope probe technique.

**QUICK START PROCEDURE**

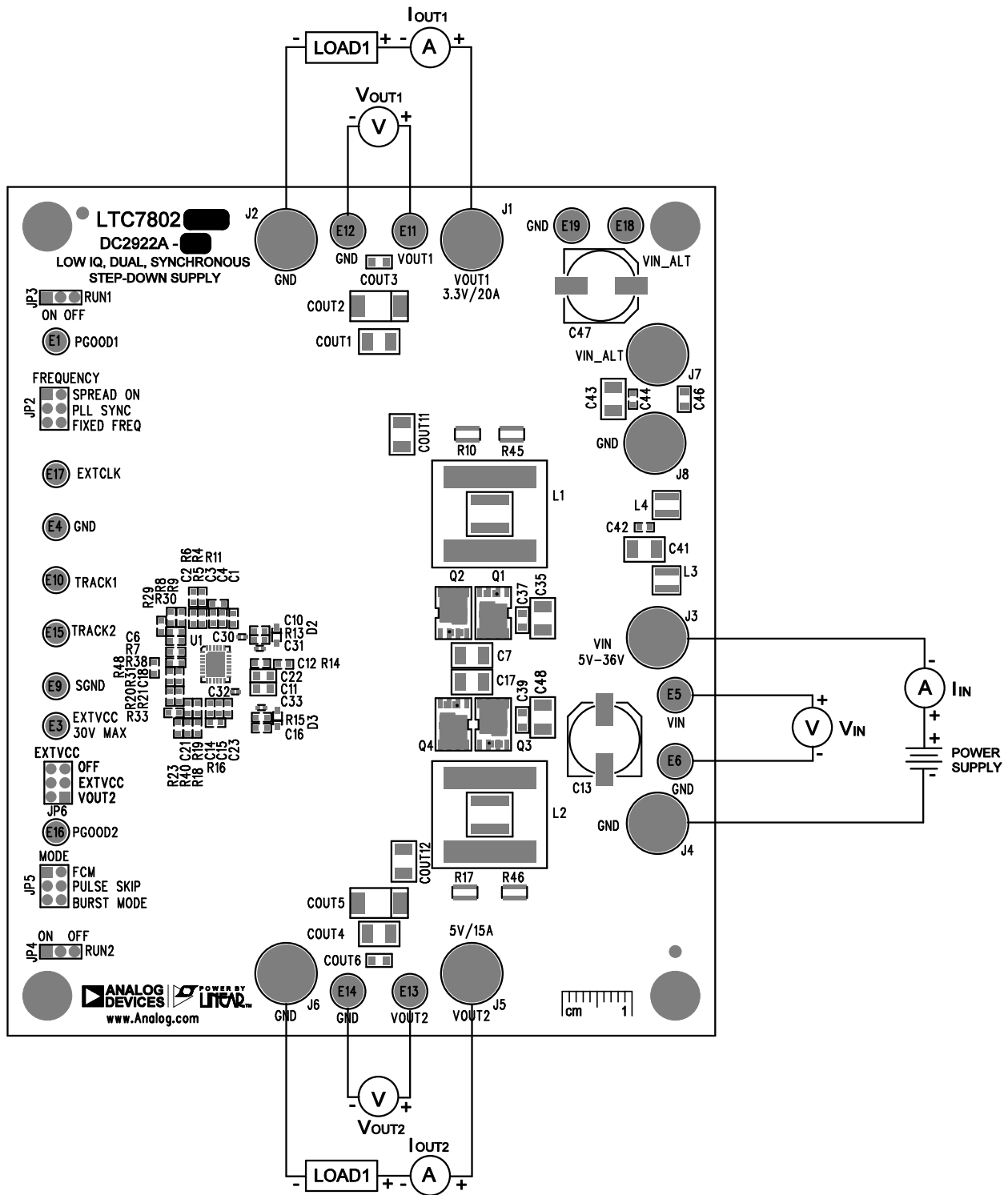
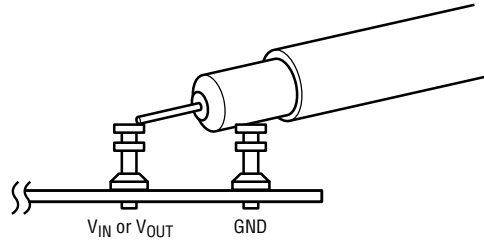
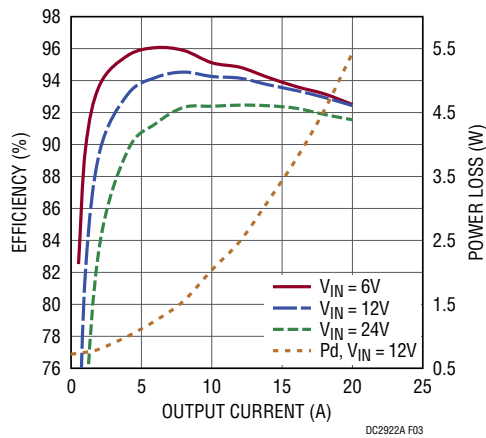

Figure 1. DC2922A Proper Equipment Setup

**QUICK START PROCEDURE**



**Figure 2. Measuring Input or Output Ripple**



**Figure 3. DC2922A 3.3V Output Efficiency vs Load Current ( $T_A = 25^\circ C$ , Forced Continuous Mode)**

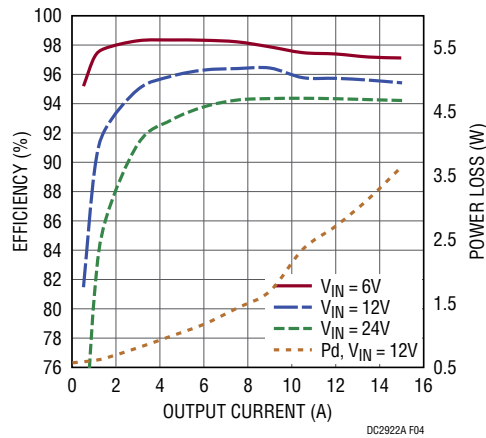

**Figure 4. DC2922A 5V Output Efficiency vs Load Current ( $T_A = 25^\circ C$ , Forced Continuous Mode)**

## QUICK START PROCEDURE

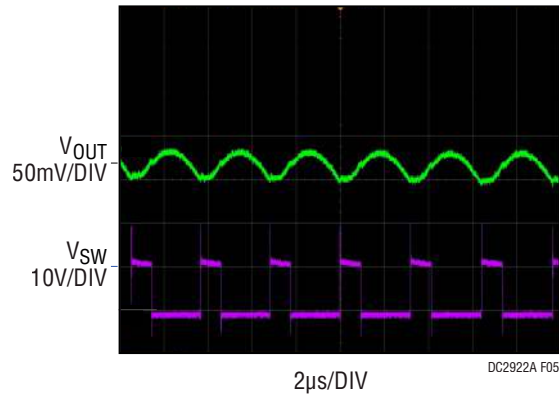

Figure 5. DC2922A 3.3V Output Ripple ( $12V_{IN}$ ,  $I_{OUT} = 20A$ )

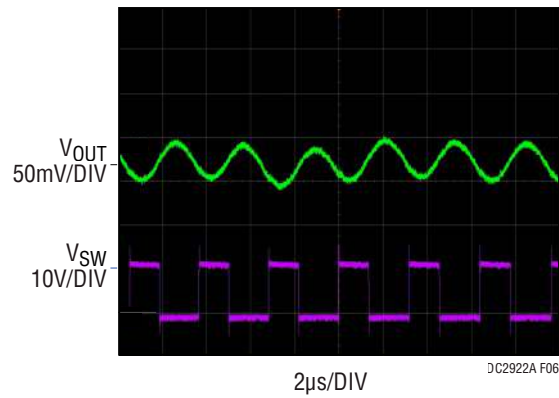

Figure 6. DC2922A 5V Output Ripple ( $12V_{IN}$ ,  $I_{OUT} = 15A$ )

### QUICK START PROCEDURE

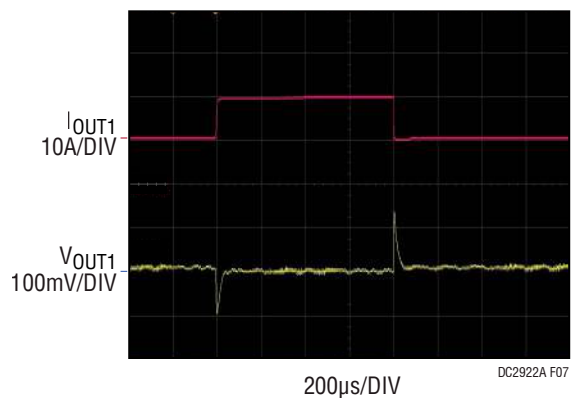

Figure 7. DC2922A 3.3V Output Transient Response ( $12V_{IN}$ ,  $I_{OUT} = 10A$  to  $20A$ )

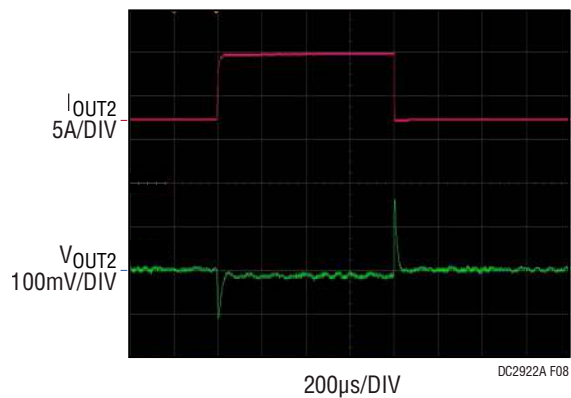

Figure 8. DC2922A 5V Output Transient Response ( $12V_{IN}$ ,  $I_{OUT} = 7.5A$  to  $15A$ )

## QUICK START PROCEDURE

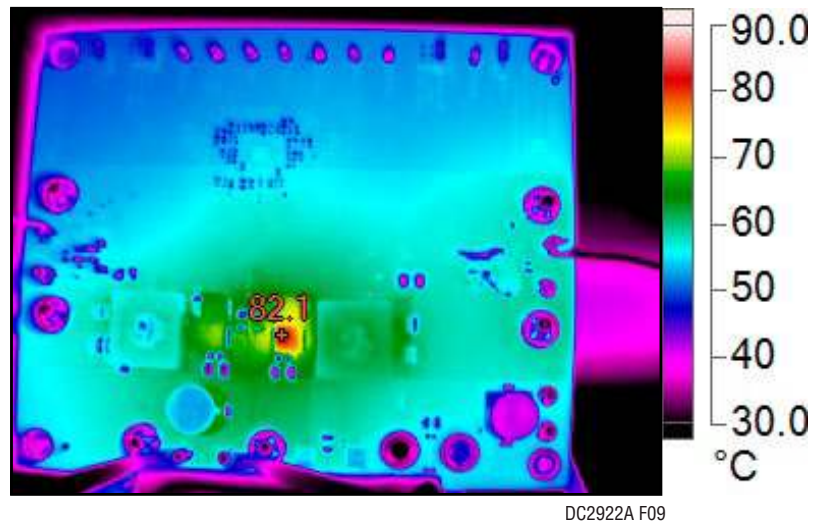

Figure 9. DC2922A Thermal Performance ( $6V_{IN}$ ,  $I_{OUT1} = 20A$ ,  $I_{OUT2} = 15A$ ,  $T_A = 25^\circ C$ )

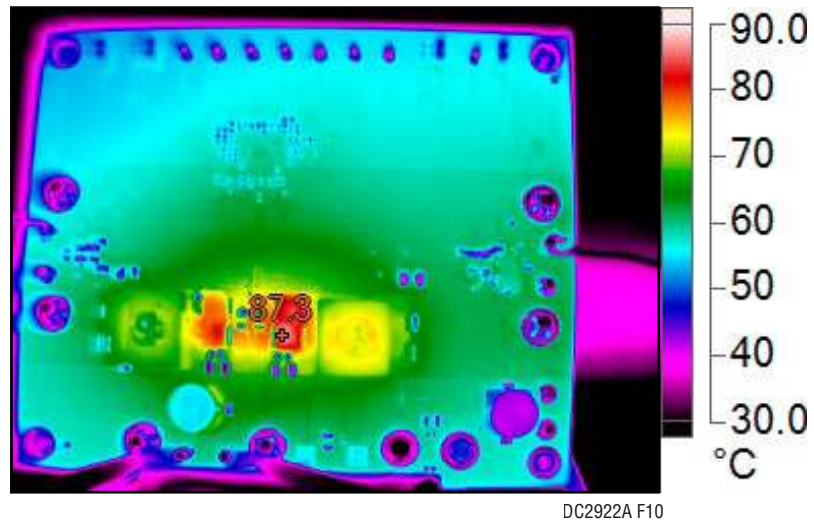

Figure 10. DC2922A Thermal Performance ( $24V_{IN}$ ,  $I_{OUT1} = 20A$ ,  $I_{OUT2} = 15A$ ,  $T_A = 25^\circ C$ )

# DEMO MANUAL

## DC2922A-A/DC2922A-B

### PARTS LIST – DC2922A-A

ITEM	QTY	REFERENCE	PART DESCRIPTION	MANUFACTURER/PART NUMBER
<b>Required Circuit Components</b>				
1	5	C1, C10, C12, C16, C23	CAP, 0.1uF, X7R, 25V, 10%, 0603	AVX, 06033C104KAT2A
2	2	C2, C21	CAP, 10pF, COG, 50V, 5%, 0603	AVX, 06035A100JAT2A
3	2	C3, C14	CAP, 220pF, COG, 50V, 5%, 0603, AEC-Q200	TDK, CGA3E2C0G1H221J080AA
4	1	C4	CAP, 2200pF, X7R, 25V, 10%, 0603	AVX, 06033C222KAT2A
5	2	C6, C18	CAP, 1000pF, X7R, 25V, 10%, 0603	AVX, 06033C102KAT2A
6	2	C7, C17	CAP, 10uF, X7R, 50V, 10%, 1210	AVX, 12105C106KAT2A
7	1	C11	CAP, 4.7uF, X7R, 16V, 10%, 0805	AVX, 0805YC475KAT2A
8	1	C13	CAP, 220uF, ALUM ELECT, 50V, 20%, 10x10.2mm, RADIAL, SMD, AEC-Q200	PANASONIC, EEEFK1H221GP
9	1	C15	CAP, 1000pF, COG, 50V, 5%, 0603, AEC-Q200	TDK, CGA3E2C0G1H102J
10	1	C22	CAP, 1uF, X7R, 50V, 10%, 0805	AVX, 08055C105KAT2A
11	3	COU1, COU7, COU11	CAP, 100uF, X5R, 6.3V, 20%, 1210	AVX, 12106D107MAT2A
12	1	COU2	CAP, 470uF, TANT, POSCAP, 6.3V, 20%, 7343, 10mOHMS, TPF	PANASONIC, 6TPF470MAH
13	2	COU3, COU6	CAP, 10uF, X7R, 10V, 10%, 0805	AVX, 0805ZC106KAT2A
14	3	COU4, COU8, COU12	CAP, 47uF, X7R, 10V, 20%, 1210	MURATA, GRM32ER71A476ME15L
15	1	COU5	CAP, 330uF, TANT, POSCAP, 10V, 20%, 7343, TPE Series	PANASONIC, 10TPE330M
16	2	D2, D3	DIODE, SCHOTTKY, 40V, 200mA, 250mW, SOD-323	CENTRAL SEMI., CMDSH-4E TR Lead Free
17	1	L1	IND., 0.74uH, PWR, SHIELDED, 20%, 59.7A, 0.86mOHMS, 16.4x15.4mm, AEC-Q200	COILCRAFT, XAL1580-741MEB
18	1	L2	IND., 1.3uH, PWR, SHIELDED, 20%, 46.7A, 1.38mOHMS, 16.4x15.4mm, AEC-Q200	COILCRAFT, XAL1580-132MEB
19	1	Q1	XSTR., MOSFET, N-CH, 40V, 59A, TDSON-8 FL	INFINEON, BSC059N04LS6
20	3	Q2-Q4	XSTR., MOSFET, N-CH, 40V, 100A, TDSON-8 FL	INFINEON, BSC022N04LS6
21	2	R1, R39	RES., 200k OHMS, 1%, 1/10W, 0603	NIC, NRC06F2003TRF
22	2	R4, R18	RES., 80.6k OHMS, 1%, 1/10W, 0603	VISHAY, CRCW060380K6FKEA
23	1	R5	RES., 255k OHMS, 1%, 1/10W, 0603, AEC-Q200	NIC, NRC06F2553TRF
24	2	R9, R21	RES., 10 OHMS, 5%, 1/10W, 0603, AEC-Q200	VISHAY, CRCW060310R0JNEA
25	2	R10, R17	RES., 0.002 OHM, 2%, 1.5W, 1206, LONG-SIDE TERM., METAL, SENSE, AEC-Q200, low EMF	SUSUMU, KRL3216E-M-R002-G-T5
26	3	R11, R16, R47	RES., 5.11k OHMS, 1%, 1/10W, 0603	PANASONIC, ERJ3EKF5111V
27	1	R19	RES., 422k OHMS, 1%, 1/10W, 0603, AEC-Q200	NIC, NRC06F4223TRF
28	1	R27	RES., 100k OHMS, 1%, 1/10W, 0603, AEC-Q200	PANASONIC, ERJ3EKF1003V
29	1	R30	RES., 46.4 OHMS, 1%, 1/10W, 0603, AEC-Q200	VISHAY, CRCW060346R4FKEA
30	2	R34, R35	RES., 1M OHM, 1%, 1/10W, 0603, AEC-Q200	VISHAY, CRCW06031M00FKEA
31	2	R36, R37	RES., 340k OHMS, 1%, 1/10W, 0603	VISHAY, CRCW0603340KfKEA
32	1	U1	IC, 2-PHASE SYN. STEP-DOWN CTRLR, QFN-28, 40V LOW IQ, DUAL, ADJ.	ANALOG DEVICES, LTC7802HUFDM#WPBF



# DEMO MANUAL

## DC2922A-A/DC2922A-B

### PARTS LIST – DC2922A-A

ITEM	QTY	REFERENCE	PART DESCRIPTION	MANUFACTURER/PART NUMBER
<b>Additional Demo Board Circuit Components</b>				
1	0	C24, C25, C34, C35, C41, C43, C48, C49	CAP, OPTION, 1210	
2	0	C28, C29, C42, C44	CAP, OPTION, 0603	
3	0	C30-C33	CAP, OPTION, 0402	
4	0	C36	CAP, OPTION, ALUM. ELECT., SMD	
5	0	C37-C40, C46	CAP, OPTION, 0805	
6	0	C47	CAP, 220uF, ALUM ELECT, 50V, 20%, 10x10.2mm, RADIAL, SMD, AEC-Q200	PANASONIC, EEEFK1H221GP
7	0	COU9, COU10	CAP, OPTION, 7343	
8	0	L3, L4	IND., 0.3uH, PWR, SHIELDED, 20%, 18.9A, 3.1mOhms, 4.3x4.3mm, XEL4030, AEC-Q200	COILCRAFT, XEL4030-301MEB
9	0	Q5-Q8	XSTR., OPTION, MOSFET N-CH, PG-TDSON-8	
10	0	R3, R24-R26, R28, R29, R31-R33, R38, R40, R43, R44, R48	RES., OPTION, 0603	
11	8	R6-R8, R13-R15, R20, R23	RES., 0 OHM, 1/10W, 0603, AEC-Q200	VISHAY, CRCW06030000Z0EA
12	0	R45, R46	RES., OPTION, 1206, LONG-SIDE TERMINAL, SENSE	
<b>Hardware: For Demo Board Only</b>				
1	8	E1, E3, E4, E9, E10, E15-E17	TEST POINT, TURRET, 0.064" MTG. HOLE, PCB 0.062" THK	MILL-MAX, 2308-2-00-80-00-00-07-0
2	8	E5, E6, E11-E14, E18, E19	TEST POINT, TURRET, 0.094" MTG. HOLE, PCB 0.062" THK	MILL-MAX, 2501-2-00-80-00-00-07-0
3	8	J1-J8	CONN., BANANA JACK, FEMALE, THT, NON-INSULATED, SWAGE, 0.218"	KEYSTONE, 575-4
4	3	JP2, JP5, JP6	CONN., HDR, MALE, 2x3, 2mm, VERT, ST, THT	SAMTEC, TMM-103-02-L-D
5	2	JP3, JP4	CONN., HDR, MALE, 1x3, 2mm, VERT, ST, THT, NO SUBS. ALLOWED	SAMTEC, TMM-103-02-L-S
6	4	MP1-MP4	STANDOFF, NYLON, SNAP-ON, 0.50"	KEYSTONE, 8833
7	5	XJP3-XJP5, XJP7, XJP8	CONN., SHUNT, FEMALE, 2-POS, 2mm	SAMTEC, 2SN-BK-G

# DEMO MANUAL

## DC2922A-A/DC2922A-B

### PARTS LIST – DC2922A-B

ITEM	QTY	REFERENCE	PART DESCRIPTION	MANUFACTURER/PART NUMBER
<b>Required Circuit Components</b>				
1	5	C1, C10, C12, C16, C23	CAP, 0.1uF, X7R, 25V, 10%, 0603	AVX, 06033C104KAT2A
2	2	C3, C14	CAP, 220pF, COG, 50V, 5%, 0603, AEC-Q200	TDK, CGA3E2C0G1H221J080AA
3	1	C4	CAP, 2200pF, X7R, 25V, 10%, 0603	AVX, 06033C222KAT2A
4	2	C6, C18	CAP, 1000pF, X7R, 25V, 10%, 0603	AVX, 06033C102KAT2A
5	2	C7, C17	CAP, 10uF, X7R, 50V, 10%, 1210	AVX, 12105C106KAT2A
6	1	C11	CAP, 4.7uF, X7R, 16V, 10%, 0805	AVX, 0805YC475KAT2A
7	1	C13	CAP, 220uF, ALUM ELECT, 50V, 20%, 10x10.2mm, RADIAL, SMD, AEC-Q200	PANASONIC, EEEFK1H221GP
8	1	C15	CAP, 1000pF, COG, 50V, 5%, 0603, AEC-Q200	TDK, CGA3E2C0G1H102J
9	1	C21	CAP, 10pF, COG, 50V, 5%, 0603	AVX, 06035A100JAT2A
10	1	C22	CAP, 1uF, X7R, 50V, 10%, 0805	AVX, 08055C105KAT2A
11	3	COUT1, COUT7, COUT11	CAP, 100uF, X5R, 6.3V, 20%, 1210	AVX, 12106D107MAT2A
12	1	COUT2	CAP, 470uF, TANT, POSCAP, 6.3V, 20%, 7343, 10mOHMS, TPF	PANASONIC, 6TPF470MAH
13	2	COUT3, COUT6	CAP, 10uF, X7R, 10V, 10%, 0805	AVX, 0805ZC106KAT2A
14	3	COUT4, COUT8, COUT12	CAP, 47uF, X7R, 10V, 20%, 1210	MURATA, GRM32ER71A476ME15L
15	1	COUT5	CAP, 330uF, TANT, POSCAP, 10V, 20%, 7343, TPE Series	PANASONIC, 10TPE330M
16	2	D2, D3	DIODE, SCHOTTKY, 40V, 200mA, 250mW, SOD-323	CENTRAL SEMI., CMDSH-4E TR Lead Free
17	1	L1	IND., 0.74uH, PWR, SHIELDED, 20%, 59.7A, 0.86mOHMS, 16.4x15.4mm, AEC-Q200	COILCRAFT, XAL1580-741MEB
18	1	L2	IND., 1.3uH, PWR, SHIELDED, 20%, 46.7A, 1.38mOHMS, 16.4x15.4mm, AEC-Q200	COILCRAFT, XAL1580-132MEB
19	1	Q1	XSTR., MOSFET, N-CH, 40V, 59A, TDSON-8 FL	INFINEON, BSC059N04LS6
20	3	Q2-Q4	XSTR., MOSFET, N-CH, 40V, 100A, TDSON-8 FL	INFINEON, BSC022N04LS6
21	2	R1, R39	RES., 200k OHMS, 1%, 1/10W, 0603	NIC, NRC06F2003TRF
22	2	R9, R21	RES., 10 OHMS, 5%, 1/10W, 0603, AEC-Q200	VISHAY, CRCW060310R0JNEA
23	2	R10, R17	RES., 0.002 OHM, 2%, 1.5W, 1206, LONG-SIDE TERM., METAL, SENSE, AEC-Q200, low EMF	SUSUMU, KRL3216E-M-R002-G-T5
24	3	R11, R16, R47	RES., 5.11k OHMS, 1%, 1/10W, 0603	PANASONIC, ERJ3EKF5111V
25	1	R18	RES., 80.6k OHMS, 1%, 1/10W, 0603	VISHAY, CRCW060380K6FKEA
26	1	R19	RES., 422k OHMS, 1%, 1/10W, 0603, AEC-Q200	NIC, NRC06F4223TRF
27	1	R27	RES., 100k OHMS, 1%, 1/10W, 0603, AEC-Q200	PANASONIC, ERJ3EKF1003V
28	1	R30	RES., 46.4 OHMS, 1%, 1/10W, 0603, AEC-Q200	VISHAY, CRCW060346R4FKEA
29	2	R34, R35	RES., 1M OHM, 1%, 1/10W, 0603, AEC-Q200	VISHAY, CRCW06031M00FKEA
30	2	R36, R37	RES., 340k OHMS, 1%, 1/10W, 0603	VISHAY, CRCW0603340KFKEA
31	1	U1	IC, 2-PHASE SYN. STEP-DOWN CTRLR, QFN-28, 40V LOW IQ, DUAL, 3.3V	ANALOG DEVICES, LTC7802HUFDM-3.3#WPBF

## PARTS LIST – DC2922A-B

ITEM	QTY	REFERENCE	PART DESCRIPTION	MANUFACTURER/PART NUMBER
<b>Additional Demo Board Circuit Components</b>				
1	0	C2, C28, C29, C42, C44	CAP, OPTION, 0603	
2	0	C24, C25, C34, C35, C41, C43, C48, C49	CAP, OPTION, 1210	
3	0	C30-C33	CAP, OPTION, 0402	
4	0	C36	CAP, OPTION, ALUM. ELECT., SMD	
5	0	C37-C40, C46	CAP, OPTION, 0805	
6	0	C47	CAP, 220uF, ALUM ELECT, 50V, 20%, 10x10.2mm, RADIAL, SMD, AEC-Q200	PANASONIC, EEEFK1H221GP
7	0	COU9, COU10	CAP, OPTION, 7343	
8	0	L3, L4	IND., 0.3uH, PWR, SHIELDED, 20%, 18.9A, 3.1mOhms, 4.3x4.3mm, XEL4030, AEC-Q200	COILCRAFT, XEL4030-301MEB
9	0	Q5-Q8	XSTR., OPTION, MOSFET N-CH, PG-TDSON-8	
10	0	R3, R4, R24-R26, R28, R29, R31-R33, R38, R40, R43, R44, R48	RES., OPTION, 0603	
11	9	R5-R8, R13-R15, R20, R23	RES., 0 OHM, 1/10W, 0603, AEC-Q200	VISHAY, CRCW06030000Z0EA
12	0	R45, R46	RES., OPTION, 1206, LONG-SIDE TERMINAL, SENSE	
<b>Hardware: For Demo Board Only</b>				
1	8	E1, E3, E4, E9, E10, E15-E17	TEST POINT, TURRET, 0.064" MTG. HOLE, PCB 0.062" THK	MILL-MAX, 2308-2-00-80-00-00-07-0
2	8	E5, E6, E11-E14, E18, E19	TEST POINT, TURRET, 0.094" MTG. HOLE, PCB 0.062" THK	MILL-MAX, 2501-2-00-80-00-00-07-0
3	8	J1-J8	CONN., BANANA JACK, FEMALE, THT, NON-INSULATED, SWAGE, 0.218"	KEYSTONE, 575-4
4	3	JP2, JP5, JP6	CONN., HDR, MALE, 2x3, 2mm, VERT, ST, THT	SAMTEC, TMM-103-02-L-D
5	2	JP3, JP4	CONN., HDR, MALE, 1x3, 2mm, VERT, ST, THT, NO SUBS. ALLOWED	SAMTEC, TMM-103-02-L-S
6	4	MP1-MP4	STANDOFF, NYLON, SNAP-ON, 0.50"	KEYSTONE, 8833
7	5	XJP3-XJP5, XJP7, XJP8	CONN., SHUNT, FEMALE, 2-POS, 2mm	SAMTEC, 2SN-BK-G

# DEMO MANUAL

## DC2922A-A/DC2922A-B

### SCHEMATIC DIAGRAM (Simplified Schematic)

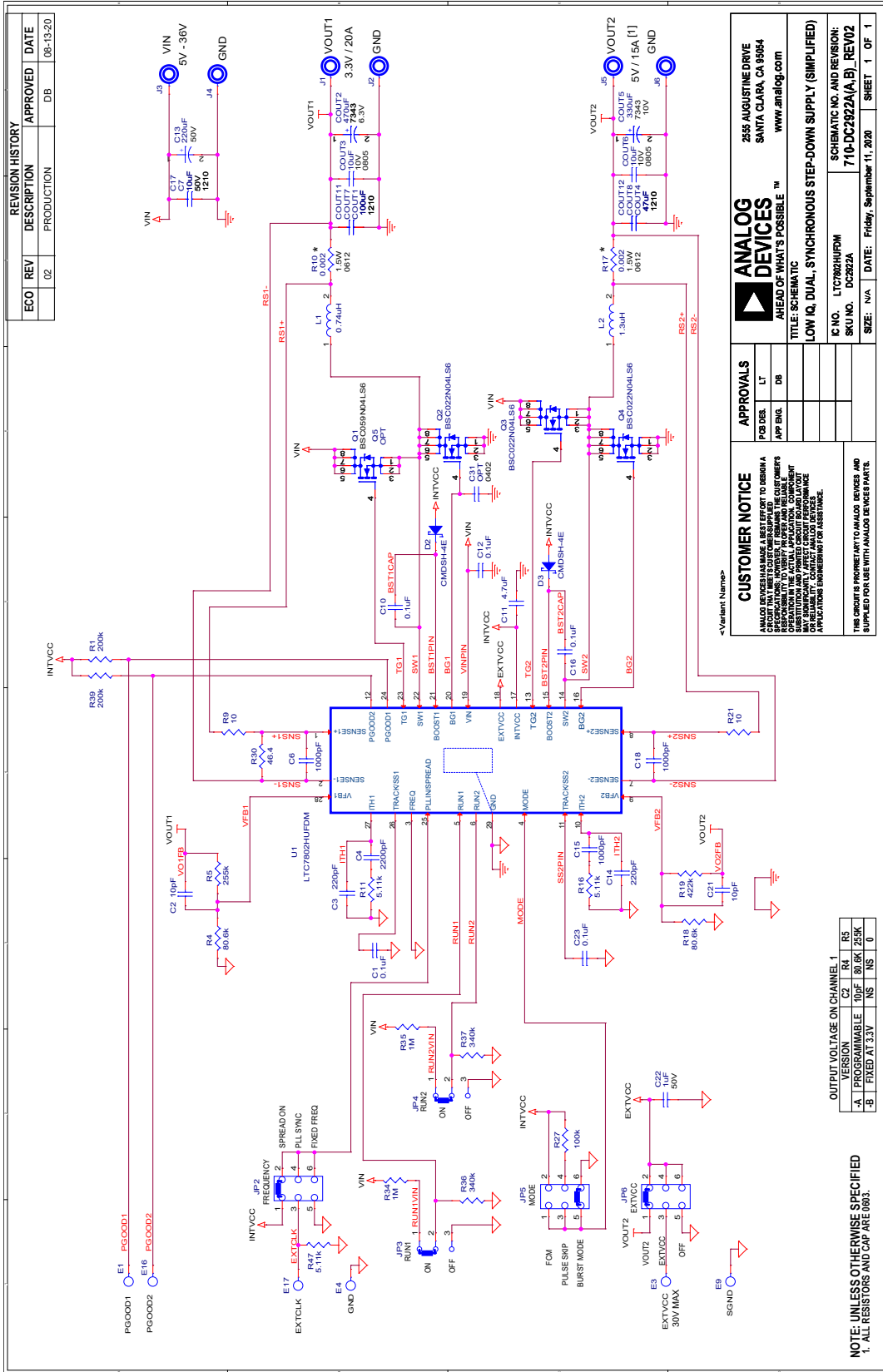

REVISION HISTORY		
ECO	REV	DESCRIPTION
	02	PRODUCTION
		APPROVED
		DATE
		DB
		08-13-20

**ANALOG DEVICES**  
255 AUGUSTINE DRIVE  
SANTA CLARA, CA 95054  
www.analog.com

**LOW IQ, DUAL, SYNCHRONOUS STEP-DOWN SUPPLY (SIMPLIFIED)**

IC NO. LTC7802HUFDM  
SKU NO. DC2922A(A,B)  
REV02

DATE: Friday, September 11, 2020  
SHEET 1 OF 1

APPROVALS  
PCB DES. LT  
APP ENG. DB

**CUSTOMER NOTICE**  
ANALOG DEVICES HAS MADE A BEST EFFORT TO DESIGN A SCHEMATIC THAT REPRESENTS THE CUSTOMER'S OPERATIONAL REQUIREMENTS. HOWEVER, IT REMAINS THE CUSTOMER'S RESPONSIBILITY TO VERIFY THE SCHEMATIC REPRESENTS THE ACTUAL OPERATIONAL REQUIREMENTS. ANALOG DEVICES DOES NOT WARRANT ANY PARTS OR CIRCUITS BEING SHOWN IN THIS SCHEMATIC. CONTACT ANALOG DEVICES AT 408.765.8176 FOR MORE INFORMATION.

THE CIRCUIT IS PROPRIETARY TO ANALOG DEVICES AND SUPPLIED FOR USE WITH ANALOG DEVICES PARTS.

OUTPUT VOLTAGE ON CHANNEL 1

VERSION	C2	R4	R5
-A- PROGRAMMABLE	10µF	80.6K	253K
-B- FIXED AT 3.3V	NS	NS	0

NOTE: UNLESS OTHERWISE SPECIFIED  
1. ALL RESISTORS AND CAP ARE 0803.

### SCHEMATIC DIAGRAM (Full Schematic)

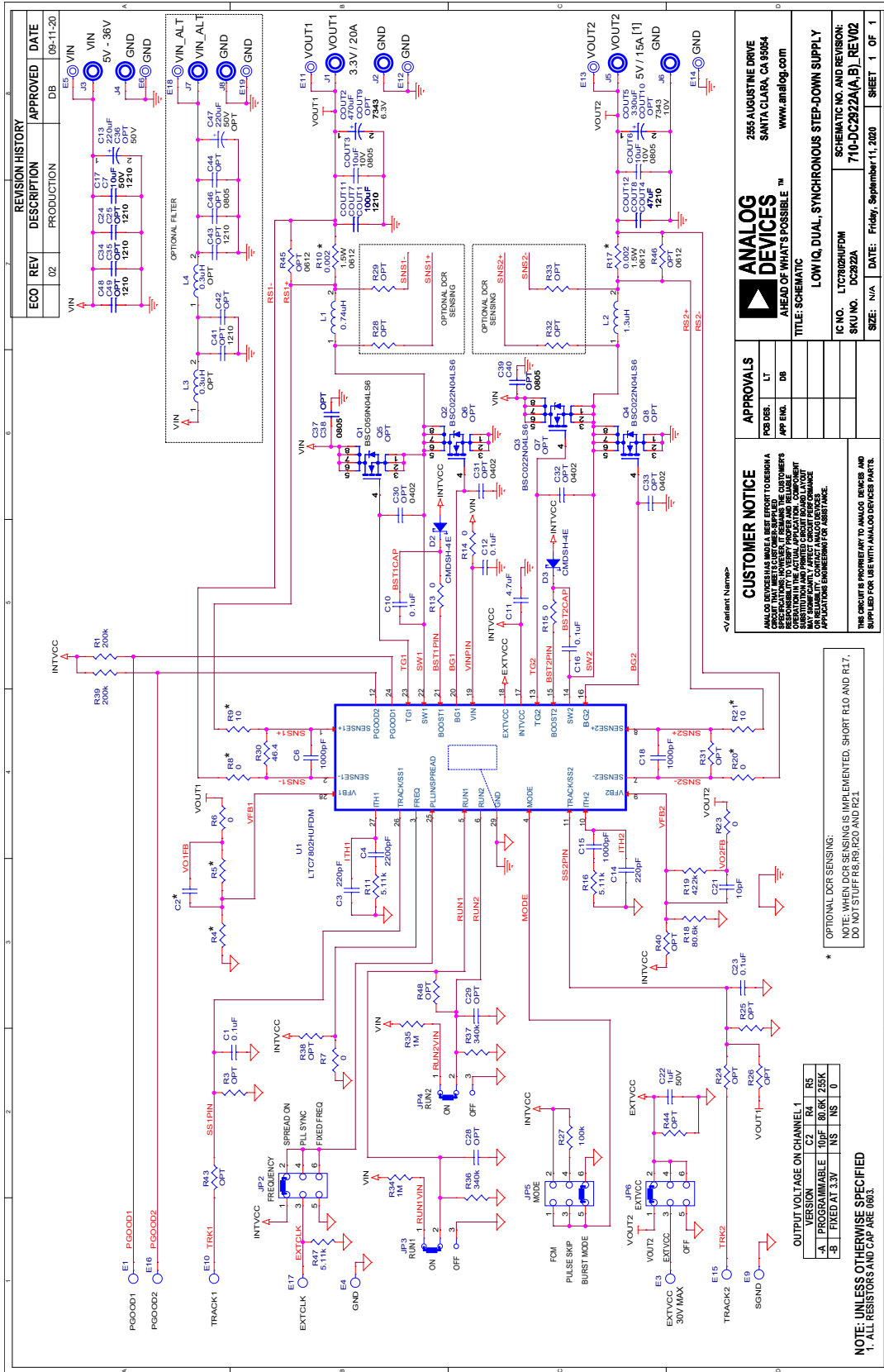

Information furnished by Analog Devices is believed to be accurate and reliable. However, no responsibility is assumed by Analog Devices for its use, nor for any infringements of patents or other rights of third parties that may result from its use. Specifications subject to change without notice. No license is granted by implication or otherwise under any patent or patent rights of Analog Devices.

# DEMO MANUAL

## DC2922A-A/DC2922A-B

---



### ESD Caution

**ESD (electrostatic discharge) sensitive device.** Charged devices and circuit boards can discharge without detection. Although this product features patented or proprietary protection circuitry, damage may occur on devices subjected to high energy ESD. Therefore, proper ESD precautions should be taken to avoid performance degradation or loss of functionality.

### Legal Terms and Conditions

By using the evaluation board discussed herein (together with any tools, components documentation or support materials, the "Evaluation Board"), you are agreeing to be bound by the terms and conditions set forth below ("Agreement") unless you have purchased the Evaluation Board, in which case the Analog Devices Standard Terms and Conditions of Sale shall govern. Do not use the Evaluation Board until you have read and agreed to the Agreement. Your use of the Evaluation Board shall signify your acceptance of the Agreement. This Agreement is made by and between you ("Customer") and Analog Devices, Inc. ("ADI"), with its principal place of business at One Technology Way, Norwood, MA 02062, USA. Subject to the terms and conditions of the Agreement, ADI hereby grants to Customer a free, limited, personal, temporary, non-exclusive, non-sublicensable, non-transferable license to use the Evaluation Board FOR EVALUATION PURPOSES ONLY. Customer understands and agrees that the Evaluation Board is provided for the sole and exclusive purpose referenced above, and agrees not to use the Evaluation Board for any other purpose. Furthermore, the license granted is expressly made subject to the following additional limitations: Customer shall not (i) rent, lease, display, sell, transfer, assign, sublicense, or distribute the Evaluation Board; and (ii) permit any Third Party to access the Evaluation Board. As used herein, the term "Third Party" includes any entity other than ADI, Customer, their employees, affiliates and in-house consultants. The Evaluation Board is NOT sold to Customer; all rights not expressly granted herein, including ownership of the Evaluation Board, are reserved by ADI. CONFIDENTIALITY. This Agreement and the Evaluation Board shall all be considered the confidential and proprietary information of ADI. Customer may not disclose or transfer any portion of the Evaluation Board to any other party for any reason. Upon discontinuation of use of the Evaluation Board or termination of this Agreement, Customer agrees to promptly return the Evaluation Board to ADI. ADDITIONAL RESTRICTIONS. Customer may not disassemble, decompile or reverse engineer chips on the Evaluation Board. Customer shall inform ADI of any occurred damages or any modifications or alterations it makes to the Evaluation Board, including but not limited to soldering or any other activity that affects the material content of the Evaluation Board. Modifications to the Evaluation Board must comply with applicable law, including but not limited to the RoHS Directive. TERMINATION. ADI may terminate this Agreement at any time upon giving written notice to Customer. Customer agrees to return to ADI the Evaluation Board at that time. LIMITATION OF LIABILITY. THE EVALUATION BOARD PROVIDED HEREUNDER IS PROVIDED "AS IS" AND ADI MAKES NO WARRANTIES OR REPRESENTATIONS OF ANY KIND WITH RESPECT TO IT. ADI SPECIFICALLY DISCLAIMS ANY REPRESENTATIONS, ENDORSEMENTS, GUARANTEES, OR WARRANTIES, EXPRESS OR IMPLIED, RELATED TO THE EVALUATION BOARD INCLUDING, BUT NOT LIMITED TO, THE IMPLIED WARRANTY OF MERCHANTABILITY, TITLE, FITNESS FOR A PARTICULAR PURPOSE OR NON-INFRINGEMENT OF INTELLECTUAL PROPERTY RIGHTS. IN NO EVENT WILL ADI AND ITS LICENSORS BE LIABLE FOR ANY INCIDENTAL, SPECIAL, INDIRECT, OR CONSEQUENTIAL DAMAGES RESULTING FROM CUSTOMER'S POSSESSION OR USE OF THE EVALUATION BOARD, INCLUDING BUT NOT LIMITED TO LOST PROFITS, DELAY COSTS, LABOR COSTS OR LOSS OF GOODWILL. ADI'S TOTAL LIABILITY FROM ANY AND ALL CAUSES SHALL BE LIMITED TO THE AMOUNT OF ONE HUNDRED US DOLLARS (\$100.00). EXPORT. Customer agrees that it will not directly or indirectly export the Evaluation Board to another country, and that it will comply with all applicable United States federal laws and regulations relating to exports. GOVERNING LAW. This Agreement shall be governed by and construed in accordance with the substantive laws of the Commonwealth of Massachusetts (excluding conflict of law rules). Any legal action regarding this Agreement will be heard in the state or federal courts having jurisdiction in Suffolk County, Massachusetts, and Customer hereby submits to the personal jurisdiction and venue of such courts. The United Nations Convention on Contracts for the International Sale of Goods shall not apply to this Agreement and is expressly disclaimed.

Rev. 0