



www.aopled.com

American Opto Plus LED Corp.
0.56" SMD Type LED Display
SMA561YG-ST-1.5 G/W
SMC561YG-ST-1.5 G/W

● **EDIT HISTORY**

Version A: Jul. 15, 2015

Preliminary spec.

Version B: Jul. 22, 2015

1. Modify mechanical dimensions.
2. Modify typical internal equivalent circuit.

Version C: Apr. 25, 2019

1. Modify absolute maximum rating.
2. Modify forward voltage max data, from 2.6V to 2.4V.
3. Modify mechanical dimensions.
4. Modify curve graph.
5. Add packing spec.



www.aopled.com

American Opto Plus LED Corp.

0.56" SMD Type LED Display

SMA561YG-ST-1.5 G/W

SMC561YG-ST-1.5 G/W

● FEATURES

- 0.56 inch (14.22 mm) Digit Height.
- Low current operation.
- Super thin SMD type.
- Gray face, White segment.
- RoHS compliant, Pb Free.

● DESCRIPTION

The SMA561YG-ST-1.5 G/W & SMC561YG-ST-1.5 G/W

Are 0.56 inch (14.22mm) height single digit 7-segment display.

This device utilizes Super Bright Yellow Green LED chip which are

Made from AlGaInP on a transparent GaAs substrate.

The display has Gray face, White segment.

● DEVICE

PART NO	DESCRIPTION
SMA561YG-ST-1.5 G/W	Common Anode
SMC561YG-ST-1.5 G/W	Common Cathode

RoHS Compliance



Pb free.





www.aopled.com

American Opto Plus LED Corp.

0.56" SMD Type LED Display

SMA561YG-ST-1.5 G/W

SMC561YG-ST-1.5 G/W

● MECHANICAL DIMENSIONS

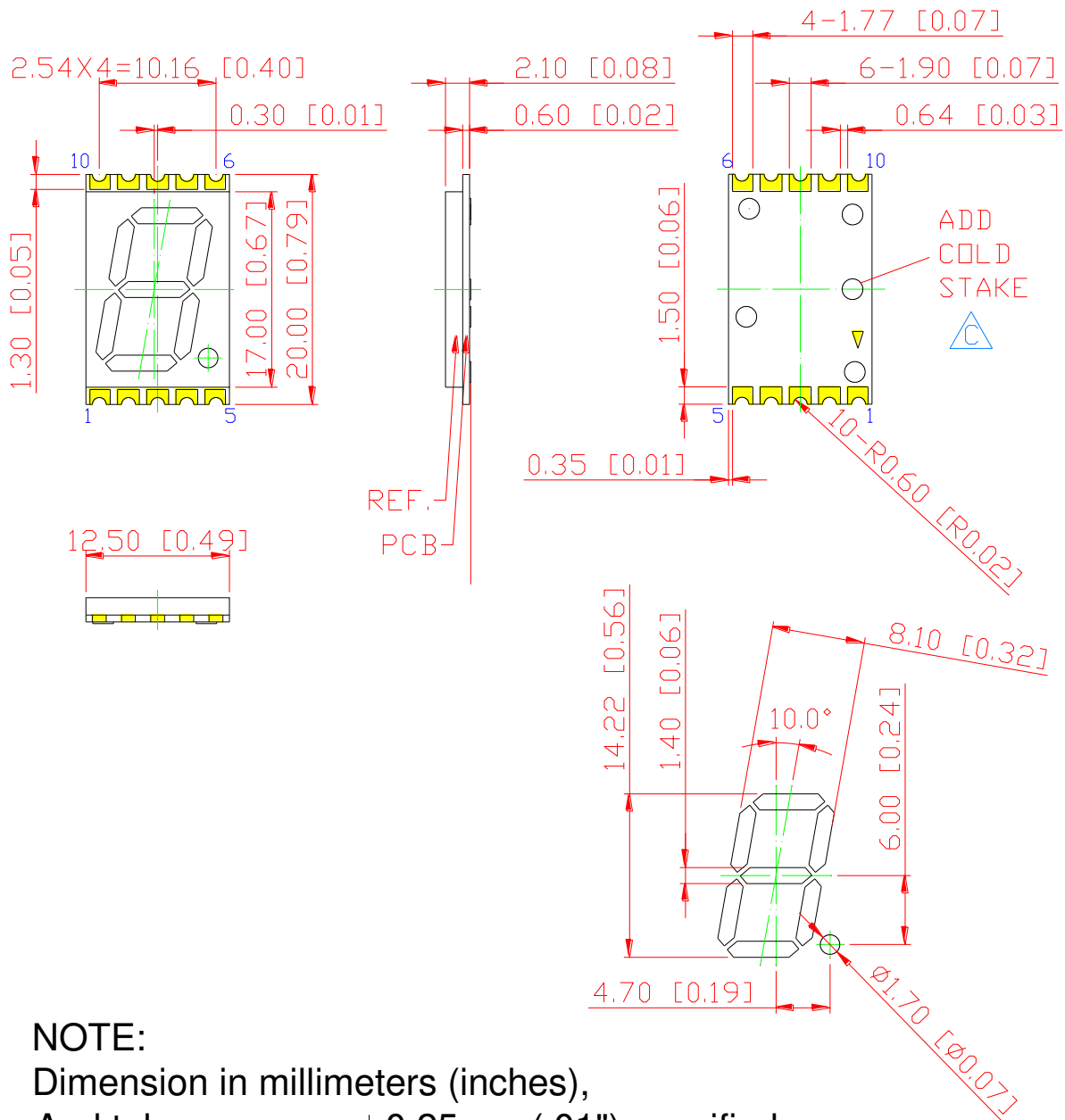

NOTE:

Dimension in millimeters (inches),
And tolerances are $\pm 0.25\text{mm}$ (.01") specified.



www.aopled.com

American Opto Plus LED Corp.

0.56" SMD Type LED Display

SMA561YG-ST-1.5 G/W

SMC561YG-ST-1.5 G/W

● TYPICAL INTERNAL EQUIVALENT CIRCUIT

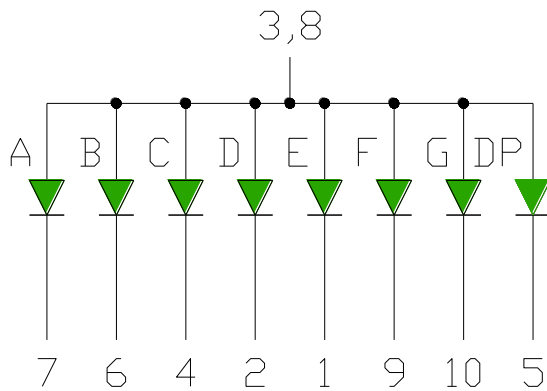
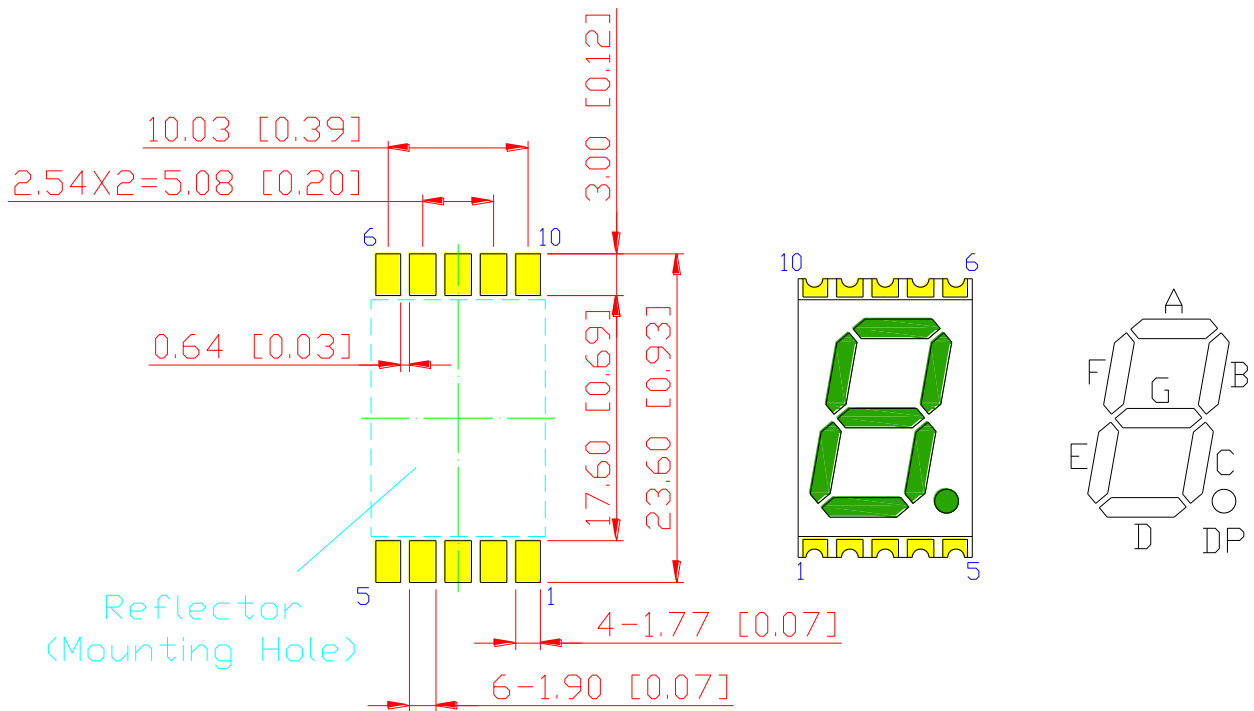

SMA561YG-ST-1.5 G/W

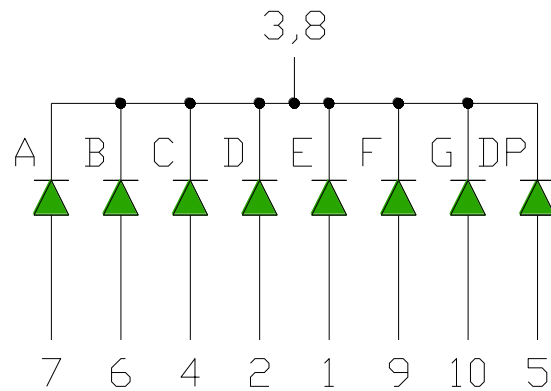

SMC561YG-ST-1.5 G/W



www.aopled.com

American Opto Plus LED Corp.
0.56" SMD Type LED Display
SMA561YG-ST-1.5 G/W
SMC561YG-ST-1.5 G/W

● **YG: SUPER BRIGHT YELLOW GREEN (AlGaInP/GaAs)**

ABSOLUTE MAXIMUM RATING AT $T_a=25^{\circ}\text{C}$

Parameter	Symbol	Maximum Rating	Unit
Power dissipation	P_{AD}	48	mW
Continuous forward current	I_{AF}	20	mA
Peak current (duty cycle 1/10, 1kHz)	I_{PF}	40	mA
Reverse voltage	V_R	5	V
Operating temperature	T_{OPR}	-40 to +85	$^{\circ}\text{C}$
Storage temperature	T_{STG}	-40 to +85	$^{\circ}\text{C}$

ELECTRICAL - OPTICAL CHARACTERISTICS AT $T_a=25^{\circ}\text{C}$

Characteristic	Symbol	Condition	Min.	Type.	Max.	Unit
Forward voltage (Per Dice)	V_F	$I_F=20\text{mA}$	-	2.1	2.4	V
Reverse current (Per Dice)	I_R	$V_R=5\text{V}$	-	-	10	μA
Peak wavelength	λ_P	$I_F=20\text{mA}$	-	573	-	nm
Dominant wavelength	λ_D	$I_F=20\text{mA}$	567	-	576	nm
Luminous intensity	I_v	$I_F=10\text{mA}$	3	-	15	mcd
Spectral Line Half-Bandwidth	$\Delta\lambda$	$I_F=20\text{mA}$	-	20	-	nm



www.aopled.com

American Opto Plus LED Corp.
0.56" SMD Type LED Display
SMA561YG-ST-1.5 G/W
SMC561YG-ST-1.5 G/W

● **YG: BIN GRADE (Unit : mcd) 10mA**

Super Bright Yellow Green	E	F	G
	3.0 – 7.0	7.1 – 11.0	11.1 – 15.0

● **YG: HUE GRADE (λ D : nm)**

1	2	3
567.0 – 570.0	570.1 – 573.0	573.1 – 576.0

● **AVAILABLE BIN / HUE TABLE**

E1	F1	G1
E2	F2	G2
E3	F3	G3



www.aopled.com

American Opto Plus LED Corp.

0.56" SMD Type LED Display

SMA561YG-ST-1.5 G/W

SMC561YG-ST-1.5 G/W

● YG: SUPER BRIGHT YELLOW GREEN (AlGaInP/GaAs) CURVE

Typical Electro-optical Characteristic Curves
(25 °C Free Air Temperature Unless Otherwise Specified)

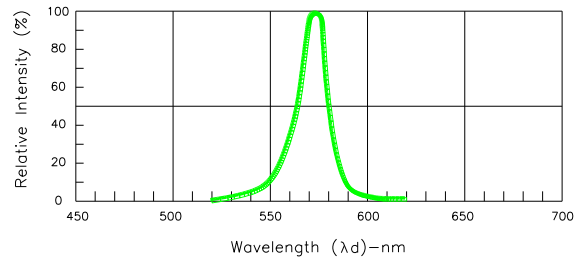

Fig.1-Relative Intensity VS. Wavelength

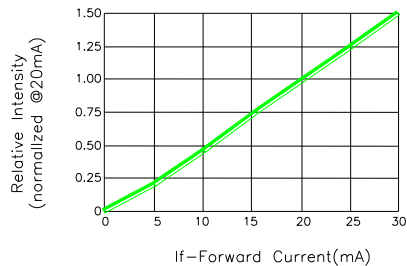

Fig.2-Relative Luminous Intensity vs. Forward Current

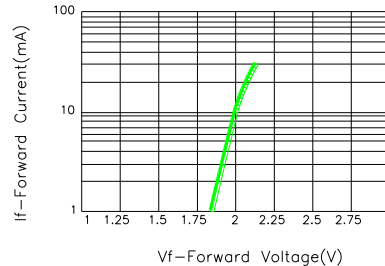

Fig.3-Forward Current vs. Forward Voltage

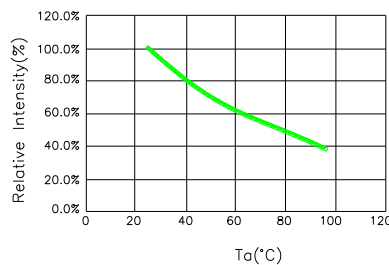

Fig.4-Relative Intensity(@20mA)VS. Ambient Temperature

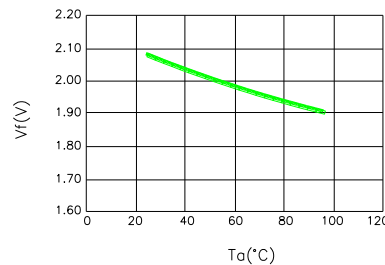

Fig.5-Forward Voltage(@20mA)VS. Ambient Temperature

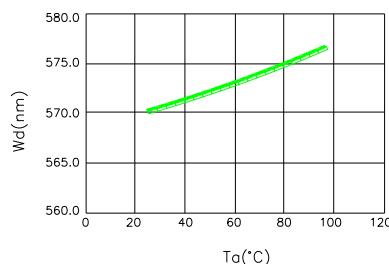

Fig.6-Dominant Wavelength(@20mA) VS. Ambient Temperature

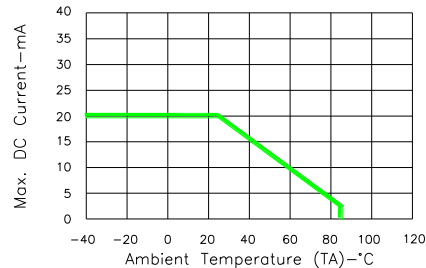

Fig.7-Max. Allowable DC Current VS. Ambient Temperature



www.aopled.com

American Opto Plus LED Corp.

0.56" SMD Type LED Display

SMA561YG-ST-1.5 G/W

SMC561YG-ST-1.5 G/W

● SMT REFLOW SOLDERING INSTRUCTIONS

SMT Soldering Profile

Pb free reflow soldering Profile

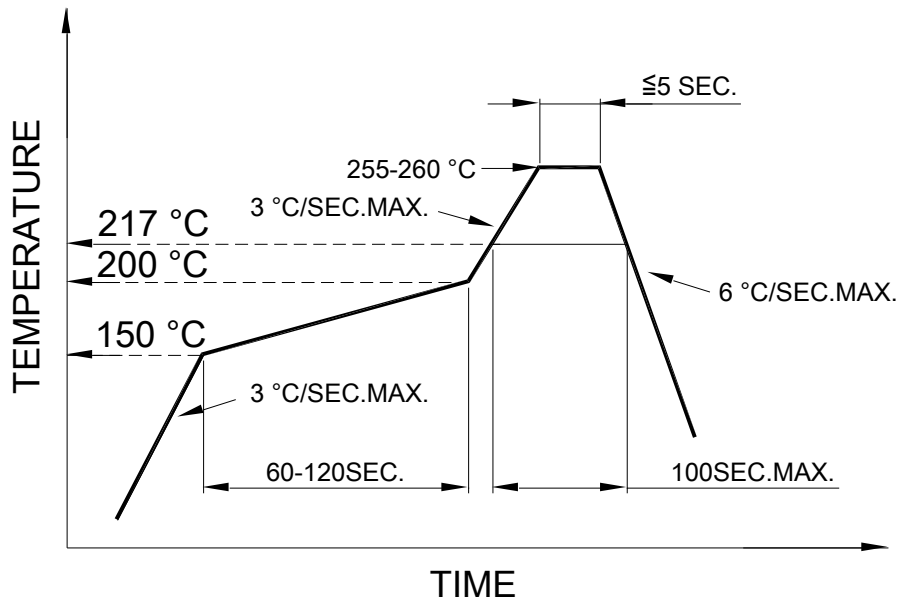

- We recommend the reflow temperature 245°C (+/- 5°C).
The maximum soldering temperature should be limited to 260°C.
- Number of reflow process shall be 2 times or less.

● SOLDERING IRON

Basic spec is ≤ 4 sec when 260°C. If temperature is higher, time should be shorter (+10°C → 1 sec). Power dissipation of Iron should be smaller Than 15W, and temperature should be controllable. Surface temperature Of the device should be under 230°C.

● REWORK

- Customer must finish rework within 3 sec. under 350°C.
- The head of soldering iron cannot touch copper foil.



www.aopled.com

American Opto Plus LED Corp.

0.56" SMD Type LED Display

SMA561YG-ST-1.5 G/W

SMC561YG-ST-1.5 G/W

● REEL DIMENSIONS

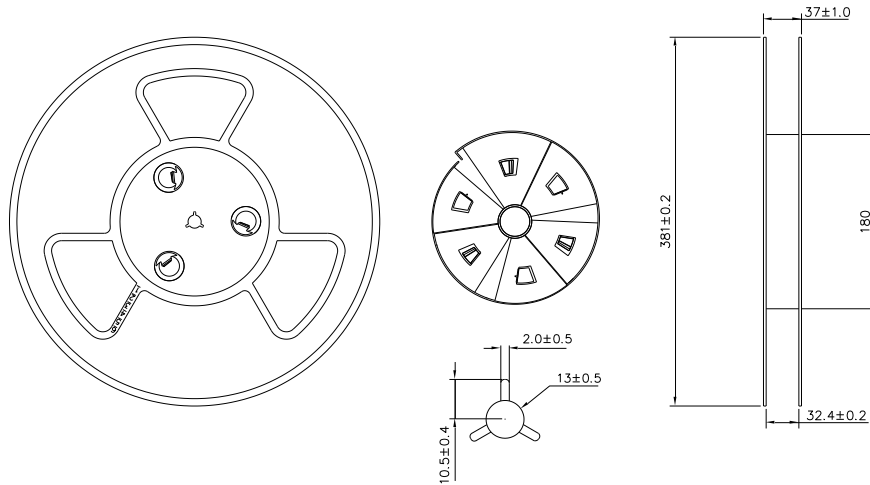

● PACKING & LABEL SPECIFICATIONS

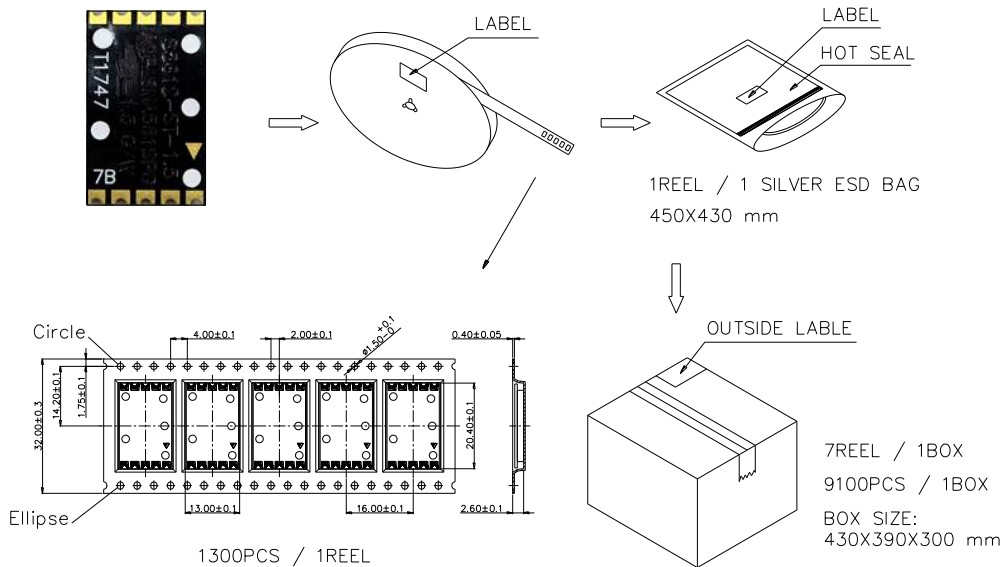

The leader and trailer length of actual tape with no component in it are 400 mm each.

● STORAGED CONDITION

In factory original sealed bag package

TEMPERATURE CONDITION	HUMIDITY CONDITION
5℃ ~ 30℃	Below 60%RH

After opened and not in factory original sealed bag package

TEMPERATURE CONDITION	HUMIDITY CONDITION	STORAGE TIME
5℃ ~ 30℃	Below 60%RH	Within 4 weeks (MSL as level 2a)