

# ISL8225MEVAL4Z

## User's Manual: Evaluation Board

### Industrial Analog and Power

All information contained in these materials, including products and product specifications, represents information on the product at the time of publication and is subject to change by Renesas Electronics Corp. without notice. Please review the latest information published by Renesas Electronics Corp. through various means, including the Renesas Electronics Corp. website (<http://www.renesas.com>).

## ISL8225MEVAL4Z

### Evaluation Board

The [ISL8225M](#) is a complete, dual step-down switching mode DC/DC power module. The dual outputs can easily be paralleled for single-output, high current use. It is easy to apply this high-power, current sharing DC/DC power module to power-hungry datacom, telecom, and FPGA applications. All that is needed to have a complete, dual 15A design ready for use are the ISL8225M, a few passive components, and  $V_{OUT}$  setting resistors.

The simplicity of the ISL8225M is its off-the-shelf, unassisted implementation. Patented current sharing in multiphase operation greatly reduces ripple currents, BOM costs, and complexity. The ISL8225M has a thermally enhanced, compact 17mmx17mmx7.5mm QFN package that operates at full load and over-temperature without requiring forced-air cooling. Easy access to all pins, with few external components, reduces PCB design to a component layer and a simple ground layer.

This ISL8225MEVAL4Z evaluation board is designed for dual 15A output applications. Optionally, this board can easily be converted for 30A single output use. Multiple ISL8225MEVAL4Z boards can be cascaded through the SYNC and CLKOUT pins to operate with phase shifting, for paralleling or multiple output use. The input voltage of this board is 4.5V to 20V and the default outputs on this board are set at 1.2V and 1.5V.

### Key Features

- Full encapsulated dual step down switching power supply
- Up to 100W output
- Dual 15A or single 30A output
- 4.5V to 20V input range
- 0.6V to 7.5V output range
- 1.5% output voltage accuracy
- Up to 95% conversion efficiency

### Specifications

This board is configured and optimized for the following operating conditions:

- $V_{IN} = 4.5V$  to 20V,  $V_{O1} = 1.2V$ ,  $V_{O2} = 1.5V$
- $I_{O1} = 15A$ ,  $I_{O2} = 15A$
- $f_{SW} = 500kHz$

### Ordering information

Part Number	Description
ISL8225MEVAL4Z	Dual 15A/Optional 30A Cascadable Evaluation Board

### Related Literature

For a full list of related documents, visit our website:

- [ISL8225M](#) device page

### Related Resources

- Evaluation Board [Video](#)

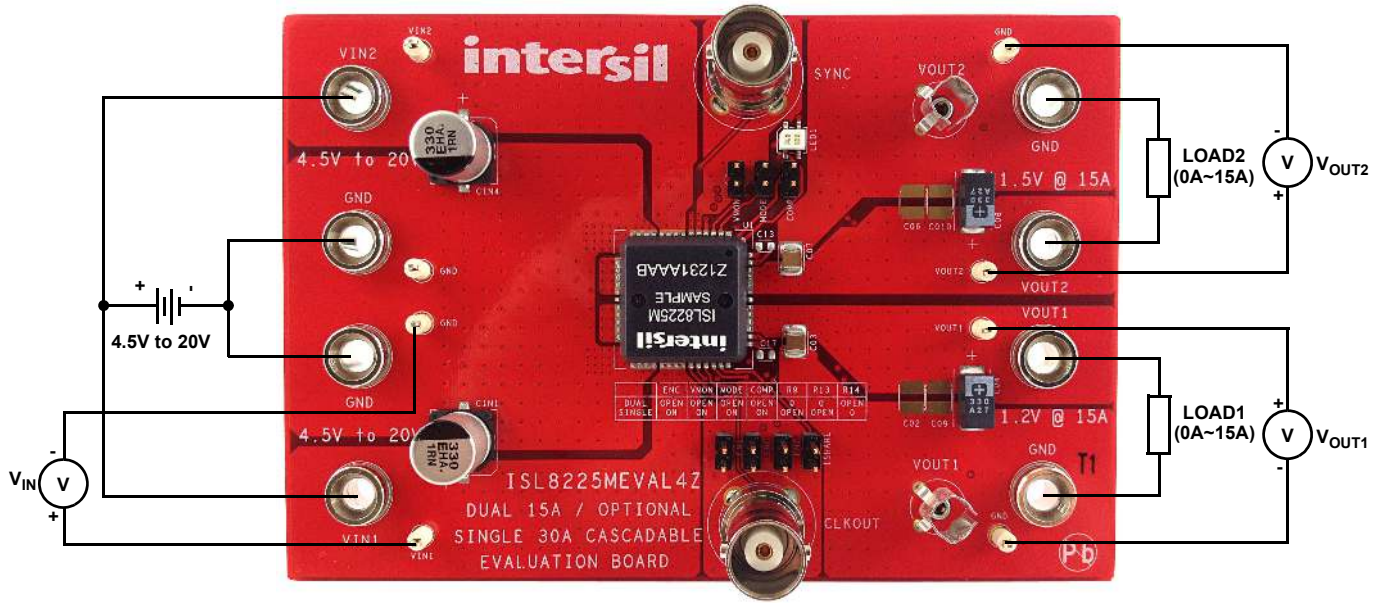

Figure 1. ISL8225MEVAL4Z Board

## 1. Functional Description

### 1.1 Recommended Equipment

- 0V to 20V power supply with at least 5A source current capability
- Electronic load capable of sinking current up to 30A
- Digital Multimeters (DMMs)
- 100MHz quad-trace oscilloscope

### 1.2 High Output Voltage Operation

The ISL8225MEVAL4Z is designed for output voltage below 5.5V. For an output voltage higher than 6V, see the “ISL8225M Design Guide Matrix” table in the [ISL8225M](#) datasheet for selections of output capacitors, input capacitors, and switching frequency. The maximum load capability of each phase is 10A for 6.5V output and 7A for 7.5V output.

### 1.3 Quick Start

For dual output operation, the inputs are BA7 (VIN1), BA8 (GND), BA3 (VIN2), and BA4 (GND). The outputs are BA5 (VOUT1), BA6 (GND), BA1 (VOUT2), and BA2 (GND).

For paralleled single output operation, the inputs are BA7 (VIN1) and BA8 (GND). The outputs are BA5 (VOUT1) and BA6 (GND) with BA5 and BA1 shorted.

#### 1.3.1 Dual Output Mode

1. Connect a power supply capable of sourcing at least 5A to the inputs BA7 (VIN1), BA8 (GND), BA3 (VIN2), and BA4 (GND) of the ISL8225MEVAL4Z, with a voltage between 4.5V to 20V. VIN1 and VIN2 can be different with R<sub>18</sub> and R<sub>19</sub> open.
2. Connect an electronic load or the device to be powered to the outputs BA5 (VOUT1) and BA6 (GND), BA1 (VOUT2) and BA2 (GND) of the board. All connections, especially the low voltage, high current V<sub>OUT</sub> lines, should be able to carry the load current and should be made as short as possible.
3. Make sure that the setup is connected correctly. Turn on the power supply. If the board is working properly, the green LED illuminates; if not, the red LED illuminates (recheck the wire/jumper connections in this case). Measure the output voltages, which should be V<sub>OUT1</sub> at 1.2V and V<sub>OUT2</sub> at 1.5V
4. For different output voltages, board resistors can be exchanged to provide the needed V<sub>OUT</sub>. See [Table 1](#) for R<sub>2</sub>/R<sub>4</sub> resistor values, which can produce different output voltages.

For 12V V<sub>IN</sub> and V<sub>OUT</sub> more than 1.5V, the switching frequency needs to be adjusted, as shown in [Table 1](#). The resistor R<sub>FSET</sub> can be adjusted for the desired frequency. No frequency adjustments are necessary for V<sub>OUT</sub> below 1.5V. For 5V V<sub>IN</sub>, the frequency does not need to be adjusted and the module default frequency can be used at any allowed V<sub>OUT</sub>. If the output voltage is set to more than 1.8V, the output current needs to be derated to allow for safe operation. See the derating curves in the [ISL8225M](#) datasheet.

**Table 1. Value of Bottom Resistor (Top Resistor R<sub>1</sub>, R<sub>3</sub> = 1kΩ) and Frequency Selection for Different Output Voltages**

V <sub>OUT</sub> (V)	R <sub>2</sub> /R <sub>4</sub> (Ω)	Frequency (kHz)	R <sub>FSET</sub> (Ω) (V <sub>IN</sub> = 12V)
1.0	1500	DEFAULT	OPEN
1.2	1000	DEFAULT	OPEN
1.5	665	DEFAULT	OPEN
2.5	316	650	249k
3.3	221	800	124k
5.0	137	950	82.5k
5.5	121	950	82.5k

**Table 1. Value of Bottom Resistor (Top Resistor  $R_1$ ,  $R_3 = 1k\Omega$ ) and Frequency Selection for Different Output Voltages (Continued)**

$V_{OUT}$ (V)	$R_2/R_4$ ( $\Omega$ )	Frequency (kHz)	$R_{FSET}$ ( $\Omega$ ) ( $V_{IN} = 12V$ )
6.5	102	750	147k
7.5	86.6	750	147k

### 1.3.2 Optional Paralleled Single Output Mode

- To set up the parallel mode, short JP1 (ENC), JP2 (VMON), and JP3 (COMP) with a jumper. To set up 180° interleaving phase between two channels, short the MODE pin and GND pin of JP6 with a jumper.
- Remove  $R_9$  and  $R_{13}$ . Change  $R_{14}$  to 0 $\Omega$ . Change  $R_{18}$  and  $R_{19}$  to 0 $\Omega$ . Short  $V_{OUT1}$  to  $V_{OUT2}$  using short wires or copper straps. Add  $C_2$  for a 470pF capacitor.
- Connect a power supply capable of sourcing at least 5A to the ISL8225MEVAL4Z's inputs, BA7 (VIN1), BA8 (GND), BA3 (VIN2), and BA4 (GND), with a voltage between 4.5V to 20V. VIN1 and VIN2 need to be shorted together.
- Connect an electronic load or the device to be powered to the board's outputs, BA5 ( $V_{OUT1}$ ) and BA6 (GND). All connections, especially the low voltage, high current  $V_{OUT}$  lines, should be able to carry the load current and should be made as short as possible.
- Make sure the setup is connected correctly prior to applying any power to the board. Adjust the power supply to 12V and turn on the input power supply. If the board is working properly, the green LED illuminates; if not, the red LED illuminates (recheck the wire/jumper connections in this case). Measure the output voltages,  $V_{OUT1}$ , which should be at 1.2V.
- Apply any load that is less than 30A for normal steady state operation. See [Table 1](#) to change the output voltage by changing resistor  $R_2$ .

**Table 2. Board Configuration for Single Output 30A Application**

	ENC	VMON	MODE	COMP	$R_9$	$R_{13}$	$R_{14}$
Dual	OPEN	OPEN	OPEN	OPEN	0	0	OPEN
Single	ON	ON	ON	ON	OPEN	OPEN	0

### 1.3.3 Optional Cascadable Mode

Cascadable mode is needed when multiple evaluation boards are used for paralleling or multiple output use. To evaluate the parallel features, Renesas recommends using the ISL8225MEVAL2Z 6-phase evaluation board for an easy and efficient setup (see [AN1789](#) "ISL8225MEVAL2Z Evaluation Board User Guide"). Otherwise, complete the following steps:

- To generate CLKOUT at a shifted phase clock signal, disable the control loop of  $V_{OUT2}$  by connecting VSEN2- to VCC.
- Program the MODE and VSEN2+ pin voltages to set the CLKOUT signal and the shifted degrees between two phases on the board (see [Table 3 on page 6](#)).
- Use a coaxial cable to connect CLKOUT (J5) to SYNC (J2) of the next evaluation board, which can be programmed for parallel or dual output use.
- If the second board is programmed for parallel use, the ISHARE pins of the first and second boards need to be tied together. Using two twisted wires, short two different jumpers of JP7 (ISHARE/SGND) on two evaluation boards. Add 1nF capacitors of  $C_{14}$  for different boards to decouple the noise.
- If the third board is used in cascadable mode, the second board can only be used in the parallel mode to generate the CLKOUT signal for the SYNC pin on the third board.
- Follow the instructions from Steps 1 through 5 for more cascadable boards.

## 2. PCB Layout Guidelines

The evaluation board size is 114.3mmx76.2mm. It is a 4-layer board that contains 2-oz copper on all layers. The board can be used as a dual 15A reference design. See "[ISL8225MEVAL4Z Board Layout](#)" on page 9. The board is made of FR4 material and all components, including the solder attachment, are Pb-free.

### 2.1 Thermal Considerations and Current Derating

For high current applications, board layout is very critical to make the module operate safely and deliver maximum allowable power. To carry large currents, the board layout needs to be designed carefully to maximize thermal performance. For best thermal performance, select enough trace width, copper weight, and the proper connectors.

This evaluation board is designed for running dual 15A at room temperature without additional cooling systems needed. However, if the output voltage is increased or the board is operated at elevated temperatures, the available current is derated. See the derated current curves in the [ISL8225M](#) datasheet to determine the output current available.

For layout of designs using the ISL8225M, the thermal performance can be improved by adhering to the following design tips:

- Use the top and bottom layers to carry the large current. VOUT1, VOUT2, Phase 1, Phase 2, PGND, VIN1, and VIN2 should have large, solid planes. Place enough thermal vias to connect the power planes in different layers under and around the module.
- The Phase 1 and Phase 2 pads are switching nodes that generate switching noise. Keep these pads under the module. For noise-sensitive applications, Renesas recommends keeping phase pads only on the top and inner layers of the PCB; do not place phase pads exposed to the outside on the bottom layer of the PCB. To improve the thermal performance, the phase pads can be extended in the inner layer, as shown in Phase 1 and Phase 2 pads on layer 2 ([Figure 5 on page 9](#)) for this dual 15A evaluation board. Make sure that layer 1 and layer 3 have the GND layers cover the extended areas of the phase pads at layer 2 to avoid noise coupling.
- Place the modules evenly on the board and leave enough space between modules. If the board space is limited, try to put the modules with low power loss closely together (such as low  $V_{OUT}$  or  $I_{OUT}$ ) while still separating the module with high power loss.
- If the ambient temperature is high or the board space is limited, airflow is needed to dissipate more heat from the modules. A heatsink can also be applied to the top side of the module to further improve the thermal performance (heatsink recommendation: Aavid Thermalloy, part number 375424B00034G, [www.aavid.com](http://www.aavid.com)).

**Table 3. ISL8225M Operation Modes**

1ST Module (I = Input; O = Output; I/O = Input and Output, Bi-Direction)										Modes of Operation		Output (See Description For Details)
Mode	EN1/FF1 (I)	EN2/FF2 (I)	VSEN2- (I)	Mode (I)	VSEN2+ (I)	CLKOUT /REFIN WRT 1st (I OR O)	VMON2 (Notes 2, 3, 4)	VMON1 of 2nd Module (Notes 2, 3, 4)	2nd Channel WRT 1st (O) (Note 1)	Operation Mode of 2nd Module	Operation Mode of 3rd Module	
1	0	0	-	-	-	-	-	-	-	-	-	Disabled
2A	0	1	Active	Active	Active	-	Active	-	VMON1 = VMON2 to Keep PGOOD Valid	-	-	Single Phase
2B	1	0	-	-	-	-	-	-	VMON1 = VMON2 to Keep PGOOD Valid	-	-	Single Phase
3A	1	1	<V <sub>CC</sub> -0.7V	Active	Active	29% to 45% of V <sub>CC</sub> (I)	Active	-	0°	-	-	Dual Regulator

**Table 3. ISL8225M Operation Modes (Continued)**

1ST Module (I = Input; O = Output; I/O = Input and Output, Bi-Direction)										Modes of Operation		Output (See Description For Details)
Mode	EN1/ FF1 (I)	EN2/ FF2 (I)	VSEN2- (I)	Mode (I)	VSEN2+ (I)	CLKOUT /REFIN WRT 1st (I OR O)	VMON2 (Notes 2, 3, 4)	VMON1 of 2nd Module (Notes 2, 3, 4)	2nd Channel WRT 1st (O) (Note 1)	Operation Mode of 2nd Module	Operation Mode of 3rd Module	
3B	1	1	<V <sub>CC</sub> -0.7V	Active	Active	45% to 62% of V <sub>CC</sub> (I)	Active	-	90°	-	-	Dual Regulator
3C	1	1	<V <sub>CC</sub> -0.7V	Active	Active	>62% of V <sub>CC</sub> (I)	Active	-	180°	-	-	Dual Regulator
4	1	1	<V <sub>CC</sub> -0.7V	Active	Active	<29% of V <sub>CC</sub> (I)	Active	-	-60°	-	-	DDR Mode
5A	1	1	V <sub>CC</sub>	GND	-	60°	VMON1 or Divider	-	180°	-	-	2-Phase
5B	1	1	V <sub>CC</sub>	GND	-	60°	Divider	Divider	180°	5B	5B	6-Phase
5C	1	1	V <sub>CC</sub>	GND	-	60°	VMON1 or Divider	Active	180°	5C	5C	3 Outputs
6	1	1	V <sub>CC</sub>	V <sub>CC</sub>	GND	120°	953Ω //22nF	Active	240°	2B	-	3-Phase
7A	1	1	V <sub>CC</sub>	V <sub>CC</sub>	V <sub>CC</sub>	90°	953Ω //22nF	Divider	180°	7A	-	4-Phase
7B	1	1	V <sub>CC</sub>	V <sub>CC</sub>	V <sub>CC</sub>	90°	953Ω //22nF	Active	180°	7B	-	2 Outputs (1st module in Mode 7A)
7C	1	1	V <sub>CC</sub>	V <sub>CC</sub>	V <sub>CC</sub>	90°	953Ω //22nF	Active	180°	3, 4	-	3 Outputs (1st module in Mode 7A)
8	Cascaded Module Operation MODEs 5B+5B+7A+5B+5B+5B/7A, No External Clock Required											12-Phase
9	External Clock or External Logic Circuits Required for Equal Phase Interval											5, 7, 8, 9, 10, 11, or (PHASE >12)

**Notes:**

1. "2nd CHANNEL WRT 1ST" means "second channel with respect to first;" in other words, Channel 2 lags Channel 1 by the degrees specified in this column. For example, 90° means Channel 2 lags Channel 1 by 90°; -60° means Channel 2 leads Channel 1 by 60°.
2. "VMON1" means that the pin is tied to the VMON1 pin of the same module.
3. "Divider" means that there is a resistor divider from V<sub>OUT</sub> to SGND; see the "Six-Phase 90A 1.2V Output Circuit" figure in the [ISL8225M](#) datasheet.
4. "953Ω//22nF" means that there is a 953Ω resistor and a 22nF capacitor connecting the pin to SGND; see the "4-Phase Paralleled at 1.5V/60A with 90° Interleaving" figure in the [ISL8225M](#) datasheet.

## 2.2 ISL8225MEVAL4Z Schematic

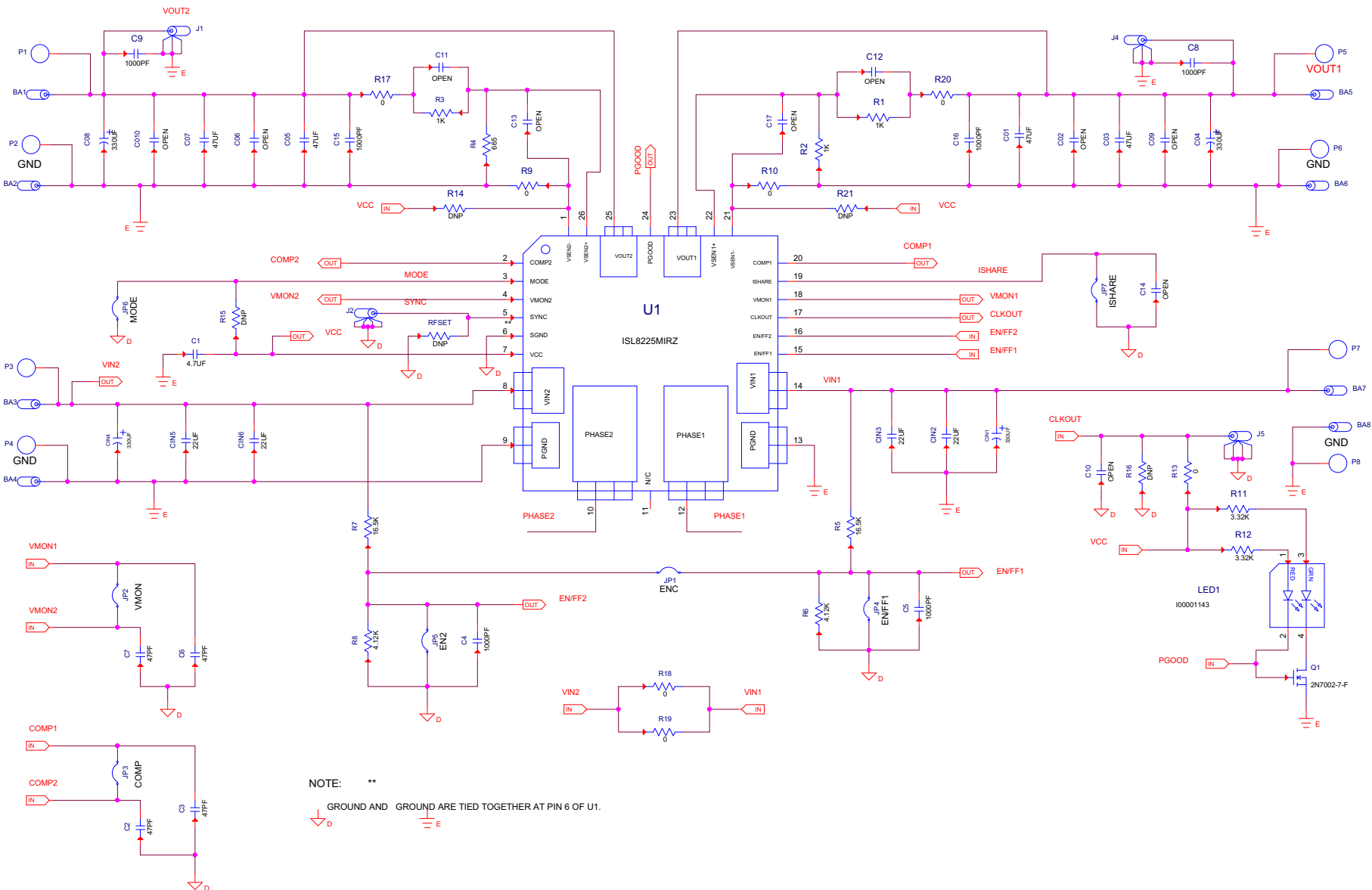

Figure 2. ISL8225MEVAL4Z Board Schematic



### 2.3 ISL8225MEVAL4Z Board Layout

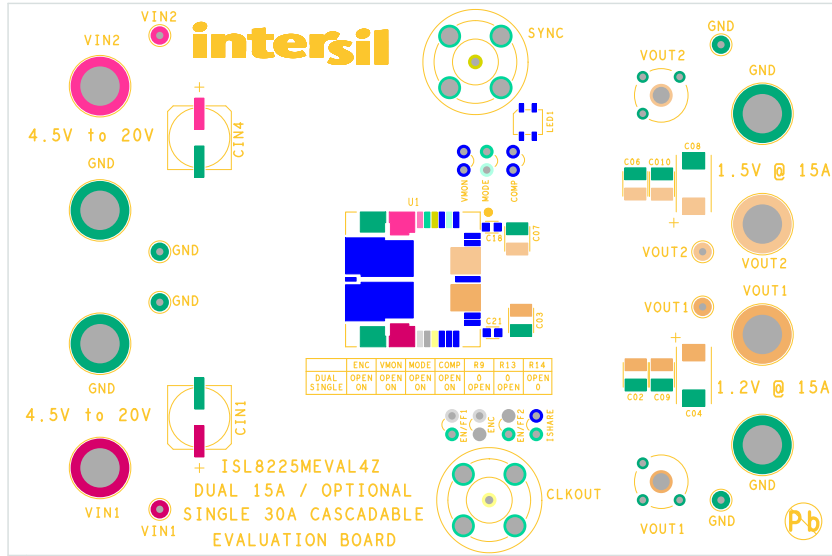

Figure 3. Top Silk Screen

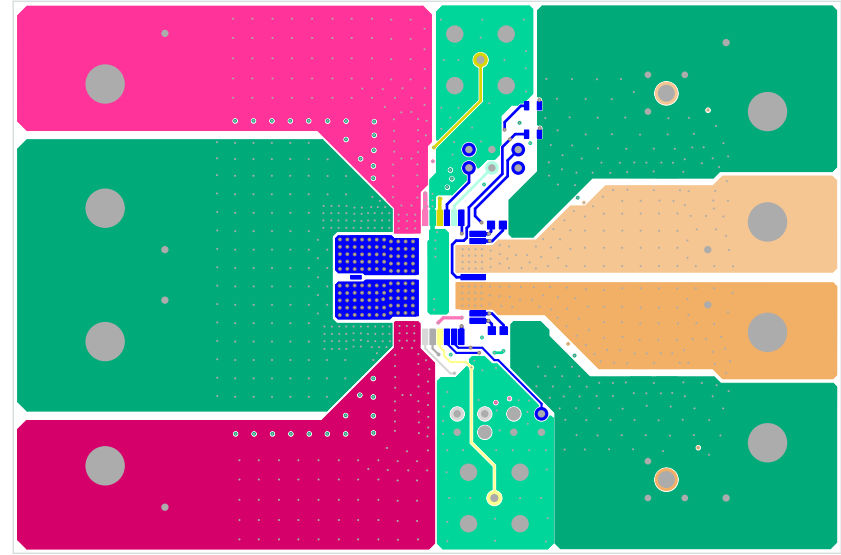

Figure 4. Top Layer Component Side

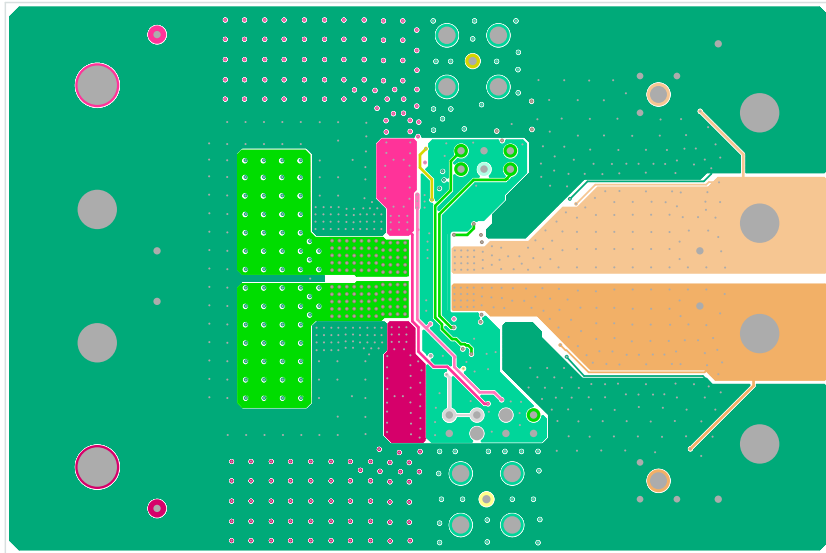

Figure 5. Layer 2

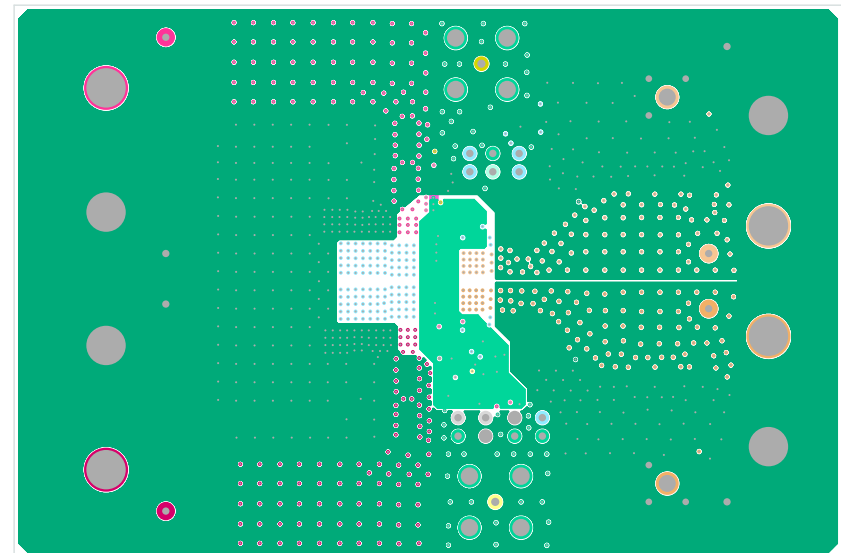
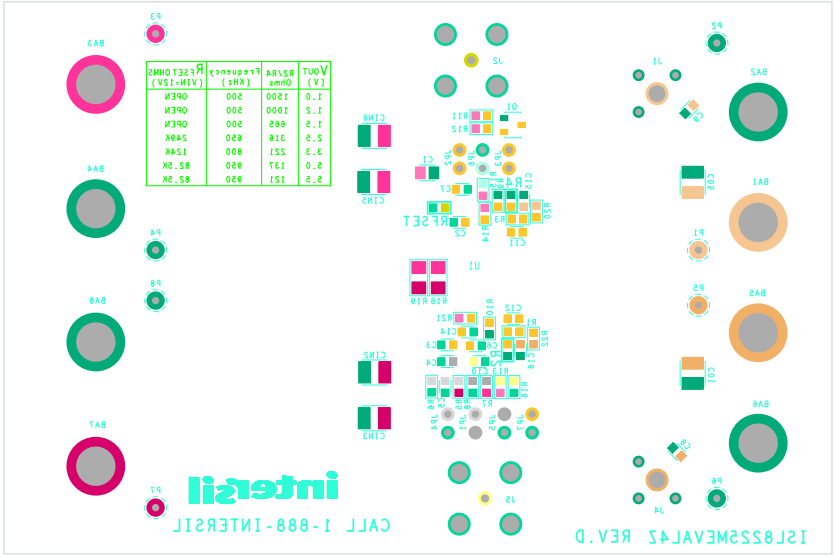

Figure 6. Layer 3



## 2.4 Bill of Materials

Part Number	Reference Designation	Qty	Value	Tol.	Voltage	Power	Package Type	Jedec Type	Manufacturer	Description
10TPB330M	C04, C08	2	330 $\mu$ F	20%	10V		SMD	CAP_7343_149		
131-4353-00	J1, J4	2					CONN	TEK131-4353-00		
2N7002-7-F	Q1	1					SOT23	SOT23		
31-5329-52RFX	J2, J5	2					CONN	CON_BNC_31_5329_52RFX		
5002	P1-P8	8					THOLE	MTP500X		
575-4	BA1-BA8	8					CONN	CON_BAN_575		
EEVHA1E331UP	CIN1, CIN4	2	330 $\mu$ F	20%	25V		SMD	CAPAE_315X402		
GRM21BR71C475KA73L	C1	1	4.7 $\mu$ F	10%	16V		805	CAP_0805	Murata	Ceramic Capacitor
GRM32ER71A476KE15L	C01, C03, C05, C07	4	47 $\mu$ F	10%	10V		1210	CAP_1210	Murata	Ceramic Chip Capacitor
H1045-OPEN	C2, C3, C6, C7	4	OPEN	5%	OPEN		603	CAP_0603	Generic	Multilayer Capacitor
H1045-00102-16V10	C15, C16	2	1000pF	10%	16V		603	CAP_0603	Generic	Multilayer Capacitor
H1045-00102-50V10	C4, C5, C8, C9	4	1000pF	10%	50V		603	CAP_0603	Generic	Multilayer Capacitor
H1045-OPEN	C10, C11, C12, C14	6	OPEN	5%	OPEN		603	CAP_0603	Generic	Multilayer Capacitor
H1082-OPEN	C02, C06, C09, C010	4	OPEN	10%	OPEN		1210	CAP_1210	Generic	Ceramic Chip Capacitor
H2505-DNP-DNP-1	R14-R16, R21, RFSET	5	DNP	1%		DNP	603	RES_0603		
H2511-00R00-1/16W1	R9, R10, R13, R17, R20	5	0 $\Omega$	1%		1/16W	603	RES_0603		
H2511-01001-1/16W1	R1, R2, R3, R6, R8	4	1k $\Omega$	1%		1/16W	603	RES_0603		
H2511-03321-1/16W1	R11, R12	2	3.32k $\Omega$	1%		1/16W	603	RES_0603		
H2511-16501-1/16W1	R5, R7	2	16.5k $\Omega$	1%		1/16W	603	RES_0603		
H2511-04121-1/16W1	R6, R8	2	4.12k $\Omega$	1%		1/16W	603	RES_0603		
H2511-06650-1/16W1	R4	1	665 $\Omega$	1%		1/16W	603	RES_0603		
H2512-OPEN	R18, R19	2	OPEN	0%		1/10W	805	RES_0805		
ISL8225MIRZ	U1	1					QFN	QFN26_670X670_ISL8225M		
JUMPER2_100	JP1-JP7	7					THOLE	JUMPER-1		
SSL-LXA3025IGC	LED1	1					SMD	LED_3X2_5MM		
TMK325B7226MM-TR	CIN2, CIN3, CIN5, CIN6	4	22 $\mu$ F	20%	25V		1210	CAP_1210	Taiyo Yuden	Ceramic Chip Capacitor

### 3. ISL8225MEVAL4Z Efficiency Curves

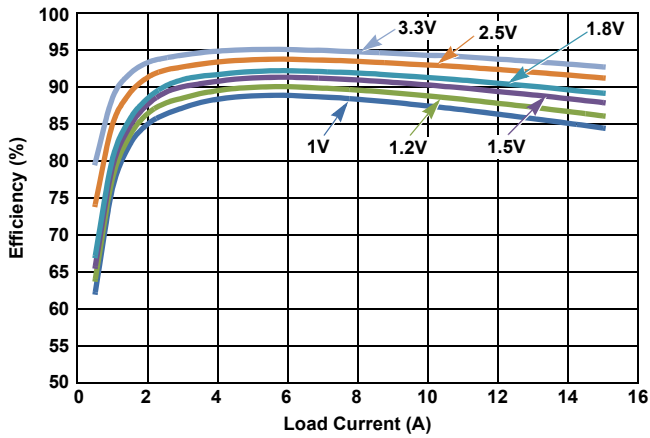

Figure 9. Efficiency vs Load Current (5V<sub>IN</sub> at 500kHz)

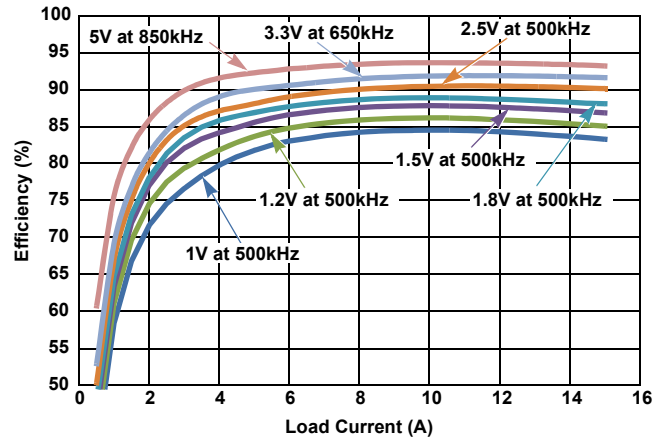

Figure 10. Efficiency vs Load Current (12V<sub>IN</sub>)

---

## 4. Revision History

Rev.	Date	Description
4.00	Jun.25.19	Applied new formatting throughout document. Replaced QR code with link to video on page 1. Updated Schematics with Orchard version. Added Revision History section.

## Notice

1. Descriptions of circuits, software and other related information in this document are provided only to illustrate the operation of semiconductor products and application examples. You are fully responsible for the incorporation or any other use of the circuits, software, and information in the design of your product or system. Renesas Electronics disclaims any and all liability for any losses and damages incurred by you or third parties arising from the use of these circuits, software, or information.
2. Renesas Electronics hereby expressly disclaims any warranties against and liability for infringement or any other claims involving patents, copyrights, or other intellectual property rights of third parties, by or arising from the use of Renesas Electronics products or technical information described in this document, including but not limited to, the product data, drawings, charts, programs, algorithms, and application examples.
3. No license, express, implied or otherwise, is granted hereby under any patents, copyrights or other intellectual property rights of Renesas Electronics or others.
4. You shall not alter, modify, copy, or reverse engineer any Renesas Electronics product, whether in whole or in part. Renesas Electronics disclaims any and all liability for any losses or damages incurred by you or third parties arising from such alteration, modification, copying or reverse engineering.
5. Renesas Electronics products are classified according to the following two quality grades: "Standard" and "High Quality". The intended applications for each Renesas Electronics product depends on the product's quality grade, as indicated below.
  - "Standard": Computers; office equipment; communications equipment; test and measurement equipment; audio and visual equipment; home electronic appliances; machine tools; personal electronic equipment; industrial robots; etc.
  - "High Quality": Transportation equipment (automobiles, trains, ships, etc.); traffic control (traffic lights); large-scale communication equipment; key financial terminal systems; safety control equipment; etc.Unless expressly designated as a high reliability product or a product for harsh environments in a Renesas Electronics data sheet or other Renesas Electronics document, Renesas Electronics products are not intended or authorized for use in products or systems that may pose a direct threat to human life or bodily injury (artificial life support devices or systems; surgical implantations; etc.), or may cause serious property damage (space system; undersea repeaters; nuclear power control systems; aircraft control systems; key plant systems; military equipment; etc.). Renesas Electronics disclaims any and all liability for any damages or losses incurred by you or any third parties arising from the use of any Renesas Electronics product that is inconsistent with any Renesas Electronics data sheet, user's manual or other Renesas Electronics document.
6. When using Renesas Electronics products, refer to the latest product information (data sheets, user's manuals, application notes, "General Notes for Handling and Using Semiconductor Devices" in the reliability handbook, etc.), and ensure that usage conditions are within the ranges specified by Renesas Electronics with respect to maximum ratings, operating power supply voltage range, heat dissipation characteristics, installation, etc. Renesas Electronics disclaims any and all liability for any malfunctions, failure or accident arising out of the use of Renesas Electronics products outside of such specified ranges.
7. Although Renesas Electronics endeavors to improve the quality and reliability of Renesas Electronics products, semiconductor products have specific characteristics, such as the occurrence of failure at a certain rate and malfunctions under certain use conditions. Unless designated as a high reliability product or a product for harsh environments in a Renesas Electronics data sheet or other Renesas Electronics document, Renesas Electronics products are not subject to radiation resistance design. You are responsible for implementing safety measures to guard against the possibility of bodily injury, injury or damage caused by fire, and/or danger to the public in the event of a failure or malfunction of Renesas Electronics products, such as safety design for hardware and software, including but not limited to redundancy, fire control and malfunction prevention, appropriate treatment for aging degradation or any other appropriate measures. Because the evaluation of microcomputer software alone is very difficult and impractical, you are responsible for evaluating the safety of the final products or systems manufactured by you.
8. Please contact a Renesas Electronics sales office for details as to environmental matters such as the environmental compatibility of each Renesas Electronics product. You are responsible for carefully and sufficiently investigating applicable laws and regulations that regulate the inclusion or use of controlled substances, including without limitation, the EU RoHS Directive, and using Renesas Electronics products in compliance with all these applicable laws and regulations. Renesas Electronics disclaims any and all liability for damages or losses occurring as a result of your noncompliance with applicable laws and regulations.
9. Renesas Electronics products and technologies shall not be used for or incorporated into any products or systems whose manufacture, use, or sale is prohibited under any applicable domestic or foreign laws or regulations. You shall comply with any applicable export control laws and regulations promulgated and administered by the governments of any countries asserting jurisdiction over the parties or transactions.
10. It is the responsibility of the buyer or distributor of Renesas Electronics products, or any other party who distributes, disposes of, or otherwise sells or transfers the product to a third party, to notify such third party in advance of the contents and conditions set forth in this document.
11. This document shall not be reprinted, reproduced or duplicated in any form, in whole or in part, without prior written consent of Renesas Electronics.
12. Please contact a Renesas Electronics sales office if you have any questions regarding the information contained in this document or Renesas Electronics products.

(Note1) "Renesas Electronics" as used in this document means Renesas Electronics Corporation and also includes its directly or indirectly controlled subsidiaries.

(Note2) "Renesas Electronics product(s)" means any product developed or manufactured by or for Renesas Electronics.

(Rev.4.0-1 November 2017)

## Corporate Headquarters

TOYOSU FORESIA, 3-2-24 Toyosu,  
Koto-ku, Tokyo 135-0061, Japan  
[www.renesas.com](http://www.renesas.com)

## Trademarks

Renesas and the Renesas logo are trademarks of Renesas Electronics Corporation. All trademarks and registered trademarks are the property of their respective owners.

## Contact Information

For further information on a product, technology, the most up-to-date version of a document, or your nearest sales office, please visit:  
[www.renesas.com/contact/](http://www.renesas.com/contact/)

ISL8225MEVAL4Z