

# TAS6422-Q1 75-W, 2-MHz Digital Input 2-Channel Automotive Class-D Audio Amplifier With Load-Dump Protection and I<sup>2</sup>C Diagnostics

## 1 Features

- Qualified for Automotive Applications
- Audio Inputs
  - 2 Channel I<sup>2</sup>S or 4/8-Channel TDM Input
  - Input Sample Rates: 44.1 kHz, 48 kHz, 96 kHz
  - Input Formats: 16-bit to 32-bit I<sup>2</sup>S, and TDM
- Audio Outputs
  - Two-Channel Bridge-Tied Load (BTL), With Option of Parallel BTL (PBTL)
  - Up to 2.1 MHz Output Switching Frequency
  - 75 W, 10% THD Into 4 Ω at 25 V
  - 45 W, 10% THD Into 2 Ω at 14.4 V
  - 150 W, 10% THD Into 2 Ω at 25 V PBTL
- Audio Performance Into 4 Ω at 14.4 V
  - THD+N < 0.03% at 1 W
  - 42 μV<sub>RMS</sub> Output Noise
  - –90 dB Crosstalk
- Load Diagnostics
  - Output Open and Shorted Load
  - Output-to-Battery or Ground Shorts
  - Line Output Detection Up to 6 kΩ
  - Runs Without Input Clocks
  - AC Diagnostic for Tweeter detection
- Protection
  - Output Current Limiting
  - Output Short Protection
  - 40 V Load Dump
  - Open Ground and Power Tolerant
  - DC Offset
  - Overtemperature
  - Undervoltage and Overvoltage
- General Operation
  - EVM Passes CISPR25-L5 EMC Specification
  - 4.5 V to 26.4 V Supply voltage
  - I<sup>2</sup>C Control With 4 Address Options
  - Clip Detection and Thermal Warning

## 2 Applications

- Automotive Head Units
- Automotive External Amplifier Modules

## 3 Description

The TAS6422-Q1 device is a Two-channel digital-input Class-D audio amplifier designed for use in automotive head units and external amplifier modules. The device provides two channels at 27 W into 4 Ω at 10% THD+N and 45 W into 2 Ω at 10% THD+N from a 14.4 V supply and 75 W into 4 Ω at 10% THD+N from a 25 V supply. The Class-D topology dramatically improves efficiency over traditional linear amplifier solutions. The output switching frequency can be set either above the AM band, which eliminates the AM-band interference and reduces output filtering and cost, or below AM band to optimize efficiency.

The wide supply-voltage range from 4.5 V to 26.4 V helps minimize audio artefacts in start-stop applications

The device incorporates all the functionality required to perform in the demanding OEM applications area. The device has a built-in load diagnostic function for detecting and diagnosing misconnected outputs as well as detection AC-coupled tweeters to help to reduce test time during the manufacturing process.

The device is offered in a 56-pin HSSOP PowerPAD™ package with the exposed thermal pad up.

For a pin compatible four-channel devices see the TAS6424-Q1 device.

### Device Information<sup>(1)</sup>

PART NUMBER	PACKAGE	BODY SIZE (NOM)
TAS6422-Q1	HSSOP (56)	18.41 mm × 7.49 mm

(1) For all available packages, see the orderable addendum at the end of the datasheet.

### PCB AREA

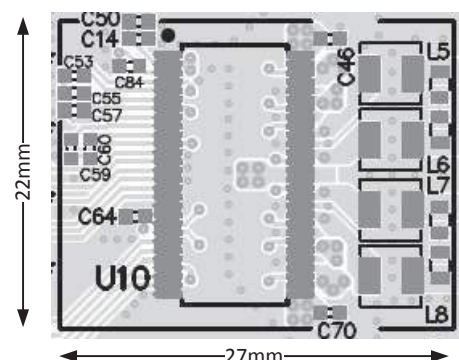

25-W 2-channel  
5.9cm<sup>2</sup>



## Table of Contents

<b>1</b>	<b>Features</b> .....	<b>1</b>	9.4	Device Functional Modes .....	<b>28</b>
<b>2</b>	<b>Applications</b> .....	<b>1</b>	9.5	Programming .....	<b>28</b>
<b>3</b>	<b>Description</b> .....	<b>1</b>	9.6	Register Maps .....	<b>32</b>
<b>4</b>	<b>Revision History</b> .....	<b>2</b>	<b>10</b>	<b>Application and Implementation</b> .....	<b>46</b>
<b>5</b>	<b>Device Comparison Table</b> .....	<b>3</b>	10.1	Application Information .....	<b>46</b>
<b>6</b>	<b>Pin Configuration and Functions</b> .....	<b>4</b>	10.2	Typical Application .....	<b>47</b>
<b>7</b>	<b>Specifications</b> .....	<b>6</b>	<b>11</b>	<b>Power Supply Recommendations</b> .....	<b>51</b>
7.1	Absolute Maximum Ratings .....	<b>6</b>	<b>12</b>	<b>Layout</b> .....	<b>51</b>
7.2	ESD Ratings .....	<b>6</b>	12.1	Layout Guidelines .....	<b>51</b>
7.3	Recommended Operating Conditions .....	<b>7</b>	12.2	Layout Example .....	<b>53</b>
7.4	Thermal Information .....	<b>7</b>	12.3	Thermal Considerations .....	<b>53</b>
7.5	Electrical Characteristics .....	<b>7</b>	<b>13</b>	<b>Device and Documentation Support</b> .....	<b>54</b>
7.6	Timing Requirements .....	<b>10</b>	13.1	Documentation Support .....	<b>54</b>
7.7	Typical Characteristics .....	<b>11</b>	13.2	Receiving Notification of Documentation Updates .....	<b>54</b>
<b>8</b>	<b>Parameter measurement Information</b> .....	<b>16</b>	13.3	Community Resources .....	<b>54</b>
<b>9</b>	<b>Detailed description</b> .....	<b>17</b>	13.4	Trademarks .....	<b>54</b>
9.1	Overview .....	<b>17</b>	13.5	Electrostatic Discharge Caution .....	<b>54</b>
9.2	Functional Block Diagram .....	<b>17</b>	13.6	Glossary .....	<b>54</b>
9.3	Feature Description .....	<b>18</b>	<b>14</b>	<b>Mechanical, Packaging, and Orderable Information</b> .....	<b>55</b>

## 4 Revision History

NOTE: Page numbers for previous revisions may differ from page numbers in the current version.

DATE	REVISION	NOTES
December 2016	*	Initial release.

## 5 Device Comparison Table

PART NUMBER	INPUT TYPE	CHANNEL COUNT	POWER-SUPPLY VOLTAGE RANGE	OUTPUT CURRENT LIMIT	MAXIMUM PWM FREQUENCY
TAS6424L-Q1	Digital	4	4.5 V to 18 V	4.8 A	2.1 MHz
TAS6424-Q1	Digital	4	4.5 V to 26.4 V	6.5 A	2.1 MHz
TAS6422-Q1	Digital	2	4.5 V to 26.4 V	6.5 A	2.1 MHz
TAS5414C-Q1	Analog, Single-Ended	4	5.6 V to 24 V	12.7 A	500 kHz
TAS5424C-Q1	Analog, Differential	4	5.6 v to 24 V	12.7 A	500 kHz

## 6 Pin Configuration and Functions

**DKQ Package**  
**56-Pin HSSOP With Exposed Thermal Pad**  
**Top View**

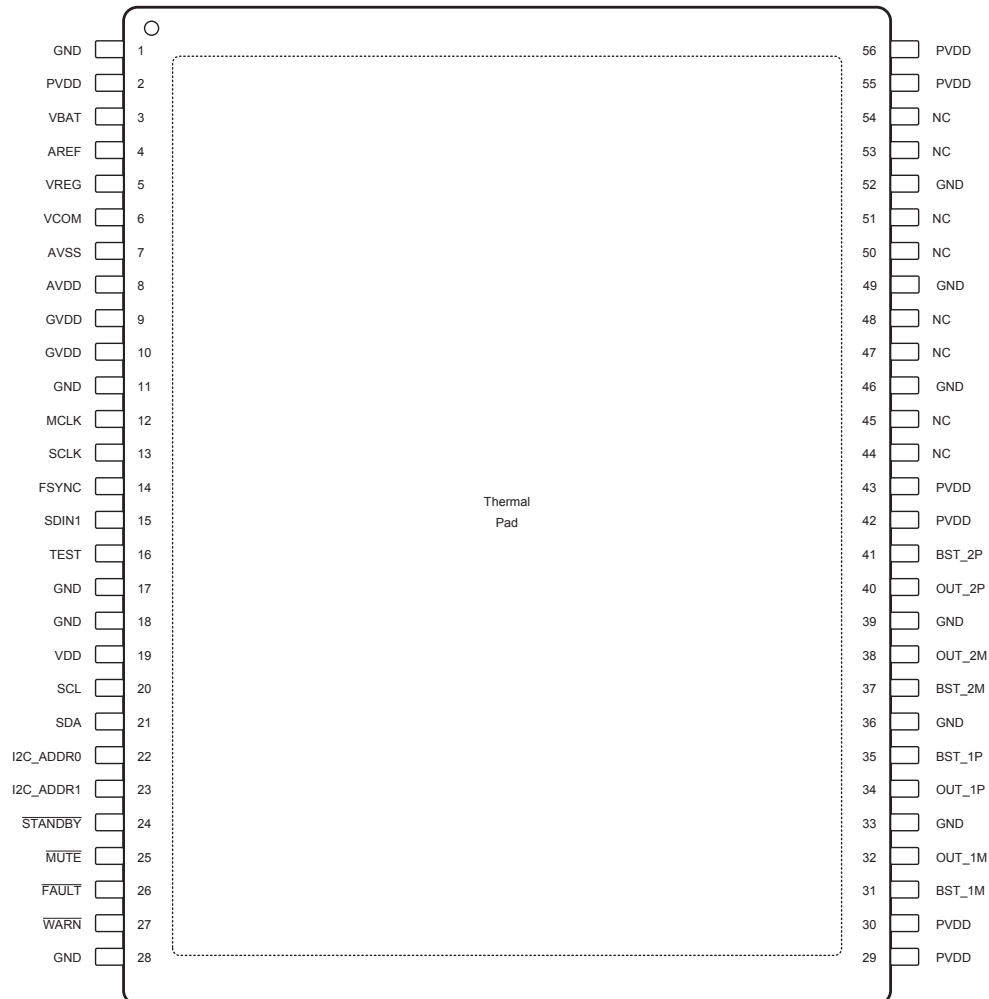

**Pin Functions**

PIN		TYPE <sup>(1)</sup>	DESCRIPTION
NAME	NO.		
AREF	4	PWR	VREG and VCOM bypass capacitor return
AVDD	8	PWR	Voltage regulator bypass
AVSS	7	PWR	AVDD bypass capacitor return
BST_1M	31	PWR	Bootstrap capacitor connection pins for high-side gate driver
BST_1P	35	PWR	Bootstrap capacitor connection pins for high-side gate driver
BST_2M	37	PWR	Bootstrap capacitor connection pins for high-side gate driver
BST_2P	41	PWR	Bootstrap capacitor connection pins for high-side gate driver
FAULT	26	DO	Reports a fault (active low, open drain), 100-k $\Omega$ internal pullup resistor
FSYNC	14	DI	Audio frame clock input

(1) GND = ground, PWR = power, PO = positive output, NO = negative output, DI = digital input, DO = digital output, DI/O = digital input and output, NC = no connection

**Pin Functions (continued)**

PIN		TYPE <sup>(1)</sup>	DESCRIPTION
NAME	NO.		
GND	1	GND	Ground
	11		
	17		
	18		
	28		
	33		
	36		
	39		
	46		
	49		
52			
GVDD	9	PWR	Gate drive voltage regulator , derived from VBAT input pin.
	10		Gate drive voltage regulator , derived from VBAT input pin.
I2C_ADDR0	22	DI	I <sup>2</sup> C address pins
I2C_ADDR1	23		
MCLK	12	DI	Audio master clock input
MUTE	25	DI	Mutes the device outputs (active low), 100-kΩ internal pulldown resistor
OUT_1M	32	NO	Negative output for the channel
OUT_1P	34	PO	Positive output for the channel
OUT_2M	38	NO	Negative output for the channel
OUT_2P	40	PO	Positive output for the channel
NC	44	NC	No connect
NC	45	NC	
NC	47	NC	
NC	48	NC	
NC	50	NC	
NC	51	NC	
NC	53	NC	
NC	54	NC	
PVDD	2	PWR	PVDD voltage input (can be connected to battery)
	29		
	30		
	42		
	43		
	55		
56			
SCL	20	DI	I <sup>2</sup> C clock input
SCLK	13	DI	Audio bit and serial clock input
SDA	21	DI/O	I <sup>2</sup> C data input and output
SDIN1	15	DI	TDM data input and audio I <sup>2</sup> S data input for channels 1 and 2
STANDBY	24	DI	Enables low power standby state (active Low), 100-kΩ internal pulldown resistor
VBAT	3	PWR	Battery voltage input
VCOM	6	PWR	Bias voltage
VDD	19	PWR	3.3-V external supply voltage
VREG	5	PWR	Voltage regulator bypass
WARN	27	DO	Clip and overtemperature warning (active low, open drain), 100-kΩ internal pullup resistor

**Pin Functions (continued)**

PIN		TYPE <sup>(1)</sup>	DESCRIPTION
NAME	NO.		
TEST	16	DI	Internal test pin, connect to GND
Thermal Pad	—	GND	Provides both electrical and thermal connection for the device. Heatsink must be connected to GND.

## 7 Specifications

### 7.1 Absolute Maximum Ratings

over operating free-air temperature range (unless otherwise noted)

		MIN	MAX	UNIT
PVDD, VBAT	DC supply voltage relative to GND	-0.3	30	V
V <sub>MAX</sub>	Transient supply voltage: PVDD, VBAT	-1	40	V
	t ≤ 400 ms exposure			
V <sub>RAMP</sub>	Supply-voltage ramp rate: PVDD, VBAT		75	V/ms
VDD	DC supply voltage relative to GND	-0.3	3.5	V
I <sub>MAX</sub>	Maximum current per pin (PVDD, VBAT, OUT_xP, OUT_xM, GND)		±8	A
I <sub>MAX_PULSED</sub>	Pulsed supply current per PVDD pin (one shot)		±12	A
	t < 100 ms			
V <sub>LOGIC</sub>	Input voltage for logic pins (SCL, SDA, SDIN1, SDIN2, MCLK, BCLK, LRCLK, MUTE, STANDBY, I2C_ADDRx)	-0.3	VDD + 0.5	V
V <sub>GND</sub>	Maximum voltage between GND pins		±0.3	V
T <sub>J</sub>	Maximum operating junction temperature	-55	150	°C
T <sub>stg</sub>	Storage temperature	-55	150	°C

### 7.2 ESD Ratings

		VALUE	UNIT	
V <sub>(ESD)</sub>	Electrostatic discharge	Human-body model (HBM), per AEC Q100-002 <sup>(1)</sup>	±3000	
		Charged-device model (CDM), per AEC Q100-011	All pins	±500
			Corner pins (1, 28, 29 and 56)	±1000

(1) AEC Q100-002 indicates that HBM stressing shall be in accordance with the ANSI/ESDA/JEDEC JS-001 specification.

### 7.3 Recommended Operating Conditions

			MIN	NOM	MAX	UNIT
PVDD	Output FET supply voltage	Relative to GND	4.5		26.4	V
VBAT	Battery supply voltage input	Relative to GND	4.5	14.4	18	V
VDD	DC logic supply	Relative to GND	3.0	3.3	3.5	V
T <sub>A</sub>	Ambient temperature		-40		125	°C
T <sub>J</sub>	Junction temperature	An adequate thermal design is required	-40		150	°C
R <sub>L</sub>	Nominal speaker load impedance	BTL Mode	2	4		Ω
		PBTL Mode	1	2		
R <sub>PU_I2C</sub>	I <sup>2</sup> C pullup resistance on SDA and SCL pins		1	4.7	10	kΩ
C <sub>Bypass</sub>	External capacitance on bypass pins	Pin 2, 3, 5, 6, 8, 9, 10, 19		1		μF
C <sub>OUT</sub>	External capacitance to GND on OUT pins	Limit set by DC-diagnostic timing		1	3.3	μF

### 7.4 Thermal Information

THERMAL METRIC <sup>(1)</sup>		TAS6422-Q1 <sup>(2)</sup>	TAS6422-Q1 <sup>(3)</sup>	UNIT
		DKQ (HSSOP)	DKQ (HSSOP)	
		56 PINS	56 PINS	
R <sub>θJA</sub>	Junction-to-ambient thermal resistance	—	—	°C/W
R <sub>θJC(top)</sub>	Junction-to-case (top) thermal resistance	1.4	2.2	°C/W
R <sub>θJB</sub>	Junction-to-board thermal resistance	—	—	°C/W
ψ <sub>JT</sub>	Junction-to-top characterization parameter	—	—	°C/W
ψ <sub>JB</sub>	Junction-to-board characterization parameter	10	10	°C/W
R <sub>θJC(bot)</sub>	Junction-to-case (bottom) thermal resistance	—	—	°C/W

(1) For more information about traditional and new thermal metrics, see the [Semiconductor and IC Package Thermal Metrics](#) application report (SPRA953).

(2) JEDEC Standard 4 Layer PCB.

(3) Measured using the TAS6422-Q1 EVM layout and heat sink. The device is not intended to be used without a heat sink.

### 7.5 Electrical Characteristics

Test conditions (unless otherwise noted): T<sub>C</sub> = 25°C, PVDD = VBAT = 14.4 V, VDD = 3.3 V, R<sub>L</sub> = 4 Ω, P<sub>out</sub> = 1 W/ch, f = 1 kHz, f<sub>SW</sub> = 2.11 MHz, AES17 Filter, default I<sup>2</sup>C settings, see [Figure 77](#)

PARAMETER		TEST CONDITIONS	MIN	TYP	MAX	UNIT
<b>OPERATING CURRENT</b>						
I <sub>PVDD_IDLE</sub>	PVDD idle current	All channels playing, no audio input		40		mA
I <sub>VBAT_IDLE</sub>	VBAT idle current	All channels playing, no audio input		80		mA
I <sub>PVDD_STBY</sub>	PVDD standby current	STANDBYActive, VDD = 0 V			10	μA
I <sub>VBAT_STBY</sub>	VBAT standby current	STANDBYActive, VDD = 0 V			10	μA
I <sub>VDD</sub>	VDD supply current	All channels playing, -60-dB signal		15		mA
<b>OUTPUT POWER</b>						
P <sub>O_BTL</sub>	Output power per channel, BTL	4 Ω, PVDD = 14.4 V, THD+N = 1%, T <sub>C</sub> = 75°C	20	22		W
		4 Ω, PVDD = 14.4 V, THD+N = 10%, T <sub>C</sub> = 75°C	25	27		
		2 Ω, PVDD = 14.4 V, THD+N = 1%, T <sub>C</sub> = 75°C	38	40		
		2 Ω, PVDD = 14.4 V, THD+N = 10%, T <sub>C</sub> = 75°C	42	45		
		4 Ω, PVDD = 25 V, THD+N = 1%, T <sub>C</sub> = 75°C	50	55		
		4 Ω, PVDD = 25 V, THD+N = 10%, T <sub>C</sub> = 75°C	70	75		
P <sub>O_PBTL</sub>	Output power per channel in parallel mode, PBTL	2 Ω, PVDD = 14.4 V, THD+N = 1%, T <sub>C</sub> = 75°C	40	40		W
		2 Ω, PVDD = 14.4 V, THD+N = 10%, T <sub>C</sub> = 75°C	50	50		
		1 Ω, PVDD = 14.4 V, THD+N = 1%, T <sub>C</sub> = 75°C	80	80		
		1 Ω, PVDD = 14.4 V, THD+N = 10%, T <sub>C</sub> = 75°C	90	90		
		2 Ω, PVDD = 25 V, THD+N = 1%, T <sub>C</sub> = 75°C	120	120		
		2 Ω, PVDD = 25 V, THD+N = 10%, T <sub>C</sub> = 75°C	150	150		
EFF <sub>P</sub>	Power efficiency	2 channels operating, 25-W output power/ch 4-Ω load, PVDD = 14.4 V, T <sub>C</sub> = 25°C		86%		

## Electrical Characteristics (continued)

Test conditions (unless otherwise noted):  $T_C = 25^\circ\text{C}$ ,  $PVDD = VBAT = 14.4\text{ V}$ ,  $VDD = 3.3\text{ V}$ ,  $R_L = 4\ \Omega$ ,  $P_{out} = 1\text{ W/ch}$ ,  $f = 1\text{ kHz}$ ,  $f_{SW} = 2.11\text{ MHz}$ , AES17 Filter, default I<sup>2</sup>C settings, see [Figure 77](#)

PARAMETER		TEST CONDITIONS	MIN	TYP	MAX	UNIT
<b>AUDIO PERFORMANCE</b>						
$V_n$	Output noise voltage	Zero input, A-weighting, gain level 1, PVDD = 14.4 V		42		$\mu\text{V}$
		Zero input, A-weighting, gain level 2, PVDD = 14.4 V		55		
		Zero input, A-weighting, gain level 3, PVDD = 18 V		67		
		Zero input, A-weighting, gain level 4, PVDD = 25 V		85		
GAIN	Peak output voltage/dBFS	Gain level 1, Register 0x01, bit 1-0 = 00		7.5		V/FS
		Gain level 2, Register 0x01, bit 1-0 = 01		15		
		Gain level 3, Register 0x01, bit 1-0 = 10		21		
		Gain level 4, Register 0x01, bit 1-0 = 11		29		
Crosstalk	Channel crosstalk	PVDD = 14.4 Vdc + 1 $V_{RMS}$ , $f = 1\text{ kHz}$		90		dB
PSRR	Power-supply rejection ratio	PVDD = 14.4 Vdc + 1 $V_{RMS}$ , $f = 1\text{ kHz}$		75		dB
THD+N	Total harmonic distortion + noise			0.02%		
$G_{CH}$	Channel-to-channel gain variation		-1	0	1	dB
<b>LINE OUTPUT PERFORMANCE</b>						
$V_{n\_LINEOUT}$	LINE output noise voltage	Zero input, A-weighting, channel set to LINE MODE		42		$\mu\text{V}$
$V_{O\_LINEOUT}$	LINE output voltage	0-dB input, channel set to LINE MODE		5.5		$V_{RMS}$
THD+N	Line output total harmonic distortion + noise	$V_O = 2\ V_{RMS}$ , channel set to LINE MODE		0.01%		
<b>DIGITAL INPUT PINS</b>						
$V_{IH}$	Input logic level high		70			%VDD
$V_{IL}$	Input logic level low				30	%VDD
$I_{IH}$	Input logic current, high	$V_I = VDD$			15	$\mu\text{A}$
$I_{IL}$	Input logic current, low	$V_I = 0$			-15	$\mu\text{A}$
<b>PWM OUTPUT STAGE</b>						
$R_{DS(on)}$	FET drain-to-source resistance	Not including bond wire and package resistance		90		m $\Omega$
<b>OVERVOLTAGE (OV) PROTECTION</b>						
$V_{PVDD\_OV}$	PVDD overvoltage shutdown		27.0	27.8	28.8	V
$V_{PVDD\_OV\_HYS}$	PVDD overvoltage shutdown hysteresis			0.3		V
$V_{VBAT\_OV}$	VBAT overvoltage shutdown		19.3	20		V
$V_{VBAT\_OV\_HYS}$	VBAT overvoltage shutdown hysteresis			0.3		V
<b>UNDERVOLTAGE (UV) PROTECTION</b>						
$VBAT_{UV}$	VBAT undervoltage shutdown			4	4.5	V
$VBAT_{UV\_HYS}$	VBAT undervoltage shutdown hysteresis			0.2		V
$PVDD_{UV}$	PVDD undervoltage shutdown			4	4.5	V
$PVDD_{UV\_HYS}$	PVDD undervoltage shutdown hysteresis			0.2		V
<b>BYPASS VOLTAGES</b>						
$V_{GVDD}$	Gate drive bypass pin voltage			7		V
$V_{AVDD}$	Analog bypass pin voltage			6		V
$V_{VCOM}$	Common bypass pin voltage			2.5		V
$V_{VREG}$	Regulator bypass pin voltage			5.5		V
<b>POWER-ON RESET (POR)</b>						
$V_{POR}$	VDD voltage for POR			2.1	2.7	V
$V_{POR\_HYS}$	VDD POR recovery hysteresis voltage			0.5		V
<b>OVERTEMPERATURE (OT) PROTECTION</b>						
OTW(i)	Channel overtemperature warning			150		$^\circ\text{C}$
OTSD(i)	Channel overtemperature shutdown			175		$^\circ\text{C}$
OTW	Global junction overtemperature warning	Set by register 0x01 bit 5-6, default value		130		$^\circ\text{C}$
OTSD	Global junction overtemperature shutdown			160		$^\circ\text{C}$



## Electrical Characteristics (continued)

Test conditions (unless otherwise noted):  $T_C = 25^\circ\text{C}$ ,  $PVDD = VBAT = 14.4\text{ V}$ ,  $VDD = 3.3\text{ V}$ ,  $R_L = 4\ \Omega$ ,  $P_{out} = 1\text{ W/ch}$ ,  $f = 1\text{ kHz}$ ,  $f_{SW} = 2.11\text{ MHz}$ , AES17 Filter, default I<sup>2</sup>C settings, see [Figure 77](#)

PARAMETER		TEST CONDITIONS	MIN	TYP	MAX	UNIT
OT <sub>HYS</sub>	Overtemperature hysteresis			15		°C
<b>LOAD OVER CURRENT PROTECTION</b>						
I <sub>LIM</sub>	Overcurrent cycle-by-cycle limit	OC Level 1	4	4.8		A
		OC Level 2	6	6.5		
I <sub>SD</sub>	Overcurrent shutdown	OC Level 1, Any short to supply, ground, or other channels		7		A
		OC Level 2, Any short to supply, ground, or other channels		9		
<b>MUTE MODE</b>						
G <sub>MUTE</sub>	Output attenuation			100		dB
<b>CLICK AND POP</b>						
V <sub>CP</sub>	Output click and pop voltage	ITU-R 2k filter, High-Z/MUTE to Play, Play to Mute/High-Z		7		mV
<b>DC OFFSET</b>						
V <sub>OFFSET</sub>	Output offset voltage			5	15	mV
<b>DC DETECT</b>						
DC <sub>FAULT</sub>	Output DC fault protection			2		V
<b>DIGITAL OUTPUT PINS</b>						
V <sub>OH</sub>	Output voltage for logic level high	I = ±2 mA	90			%VDD
V <sub>OL</sub>	Output voltage for logic level low	I = ±2 mA			10	%VDD
t <sub>DELAY_CLIPDET</sub>	Signal delay when output clipping detected				20	μs
<b>LOAD DIAGNOSTICS</b>						
S2P	Maximum resistance to detect a short from OUT pins to PVDD				500	Ω
S2G	Maximum resistance to detect a short from OUT pins to ground				200	Ω
SL	Shorted load detection tolerance	Other channels in Hi-Z			±0.5	Ω
OL	Open load	Other channels in Hi-Z	40	70		Ω
T <sub>DC_DIAG</sub>	DC diagnostic time			240		ms
LO	Line output				6	kΩ
T <sub>LINE_DIAG</sub>	Line output diagnostic time			40		ms
AC <sub>IMP</sub>	AC impedance accuracy	Gain linearity, f = 19 kHz, R <sub>L</sub> = 2 Ω to 16 Ω,		25%		
		Offset		±0.5		Ω
T <sub>AC_DIAG</sub>	AC diagnostic time			200		ms
<b>I<sup>2</sup>C_ADDR PINS</b>						
t <sub>I2C_ADDR</sub>	Time delay needed for I <sup>2</sup> C address set-up			300		μs

## 7.6 Timing Requirements

Test conditions (unless otherwise noted):  $T_C = 25\text{ }^\circ\text{C}$ ,  $PVDD = VBAT = 14.4\text{ V}$ ,  $VDD = 3.3\text{ V}$ ,  $R_L = 4\text{ }\Omega$ ,  $P_O = 1\text{ W/ch}$ ,  $f = 1\text{ kHz}$ ,  $f_{SW} = 2.11\text{ MHz}$ , AES17 Filter, default I<sup>2</sup>C settings, see [Figure 77](#)

		MIN	TYP	MAX	UNIT
<b>I<sup>2</sup>C CONTROL PORT (See <a href="#">Figure 42</a>)</b>					
$t_{BUS}$	Bus free time between start and stop conditions	1.3			$\mu\text{s}$
$t_{HOLD1}$	Hold time, SCL to SDA	0			ns
$t_{HOLD2}$	Hold time, start condition to SCL	0.6			$\mu\text{s}$
$t_{START}$	I <sup>2</sup> C startup time after VDD power on reset			12	ms
$t_{RISE}$	Rise time, SCL and SDA			300	ns
$t_{FALL}$	Fall time, SCL and SDA			300	ns
$t_{SU1}$	Setup, SDA to SCL	100			ns
$t_{SU2}$	Setup, SCL to start condition	0.6			$\mu\text{s}$
$t_{SU3}$	Setup, SCL to stop condition	0.6			$\mu\text{s}$
$t_{W(H)}$	Required pulse duration SCL <i>High</i>	0.6			$\mu\text{s}$
$t_{W(L)}$	Required pulse duration SCL <i>Low</i>	1.3			$\mu\text{s}$
<b>SERIAL AUDIO PORT (See <a href="#">Figure 36</a>)</b>					
$D_{MCLK}$ , $D_{SCLK}$	Allowable input clock duty cycle	45%	50%	55%	
$f_{MCLK}$	Supported MCLK frequencies: 128, 256, or 512	128		512	xFS
$f_{MCLK\_Max}$	Maximum frequency			25	MHz
$t_{SCY}$	SCLK pulse cycle time	40			ns
$t_{SCL}$	SCLK pulse-with LOW	16			ns
$t_{SCH}$	SCLK pulse-with HIGH	16			ns
$t_{rise/fall}$	Rise and fall time	4			ns
$t_{SF}$	SCLK rising edge to FSYNC edge	8			ns
$t_{FS}$	FSYNC rising edge to SCLK edge	8			ns
$t_{DS}$	DATA set-up time	8			ns
$t_{DH}$	DATA hold time	8			ns
$c_i$	Input capacitance, pins MCLK, SCLK, FSYNC, SDIN1, SDIN2			10	pF
$T_{LA}$	Latency from input to output measured in FSYNC sample count	FSYNC = 44.1 kHz or 48 kHz			30
		FSYNC = 96 kHz			12

### 7.7 Typical Characteristics

$T_A = 25\text{ }^\circ\text{C}$ ,  $V_{DD} = 3.3\text{ V}$ ,  $V_{BAT} = PV_{DD} = 14.4\text{ V}$ ,  $R_L = 4\text{ }\Omega$ ,  $f_{IN} = 1\text{ kHz}$ ,  $f_s = 48\text{ kHz}$ ,  $f_{SW} = 2.1\text{ MHz}$ , AES17 filter, default I<sup>2</sup>C settings, see Figure 77 (unless otherwise noted)

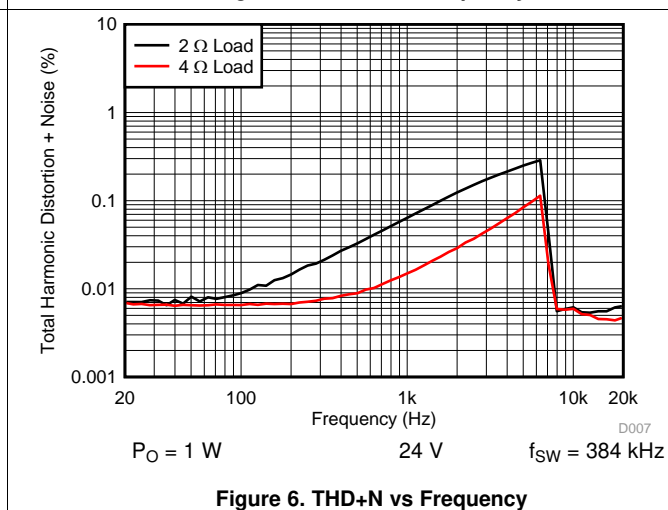
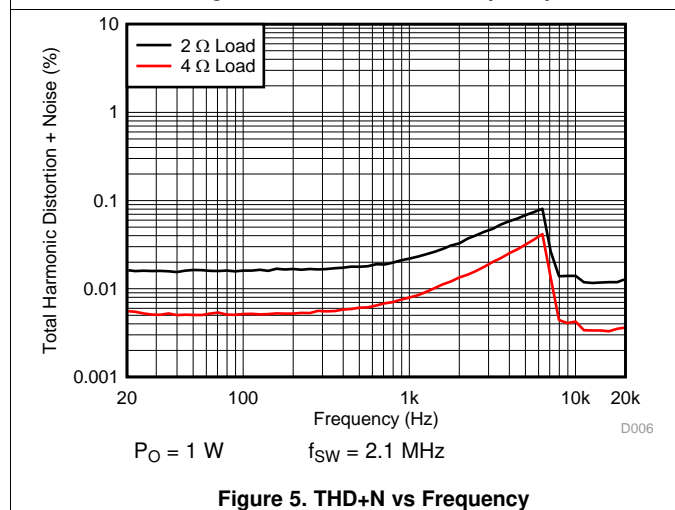
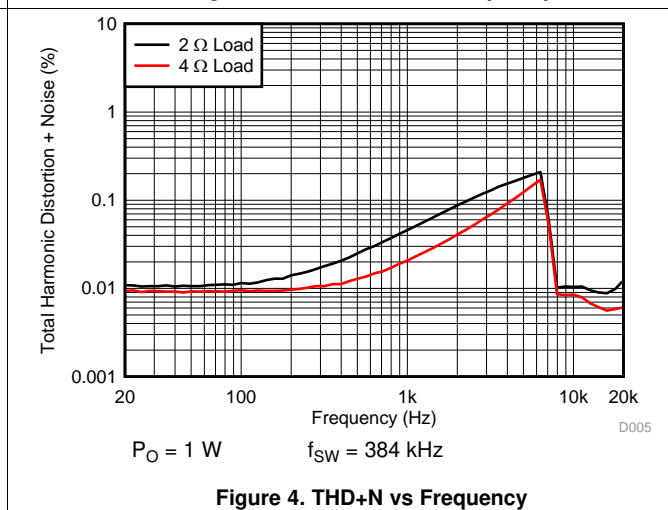
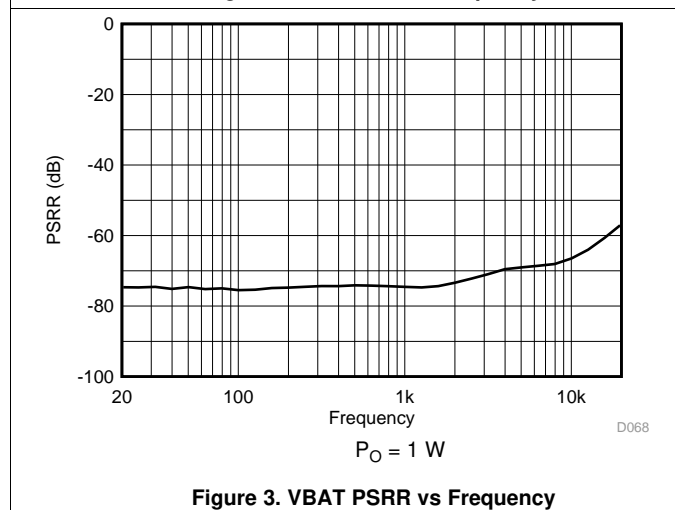
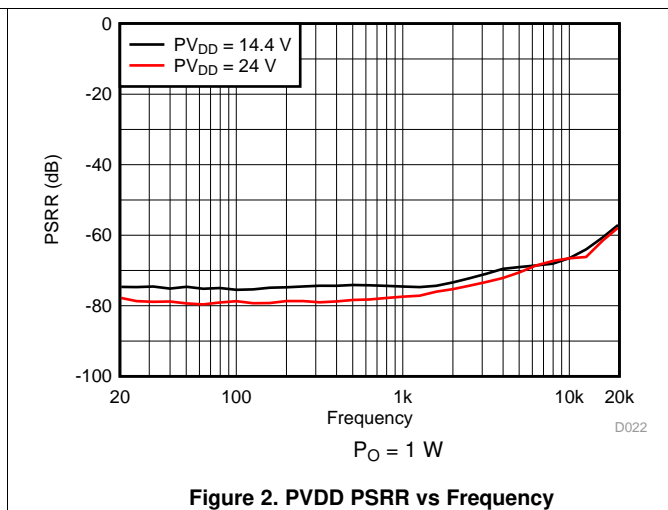
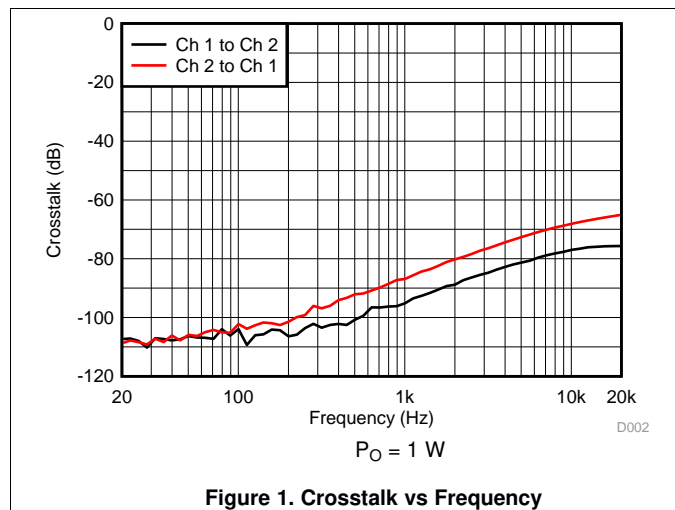

Typical Characteristics (continued)

$T_A = 25\text{ }^\circ\text{C}$ ,  $V_{VDD} = 3.3\text{ V}$ ,  $V_{BAT} = PVDD = 14.4\text{ V}$ ,  $R_L = 4\ \Omega$ ,  $f_{IN} = 1\text{ kHz}$ ,  $f_s = 48\text{ kHz}$ ,  $f_{SW} = 2.1\text{ MHz}$ , AES17 filter, default I<sup>2</sup>C settings, see Figure 77 (unless otherwise noted)

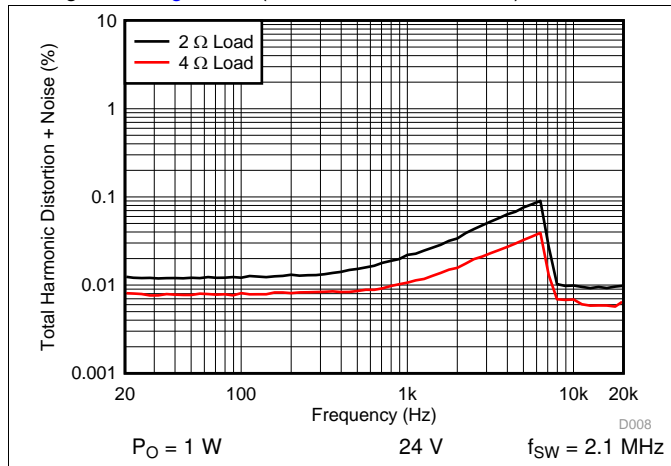

Figure 7. THD+N vs Frequency

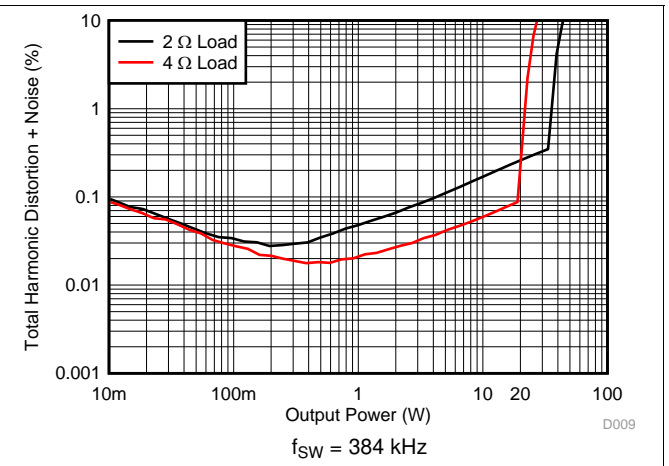

Figure 8. THD+N vs Power

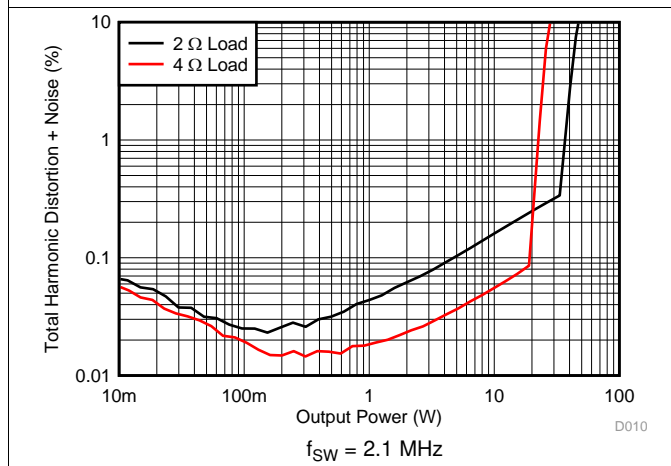

Figure 9. THD+N vs Power

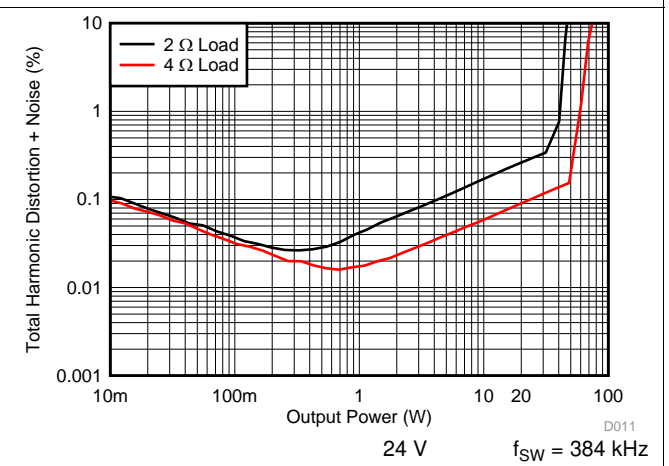

Figure 10. THD+N vs Power

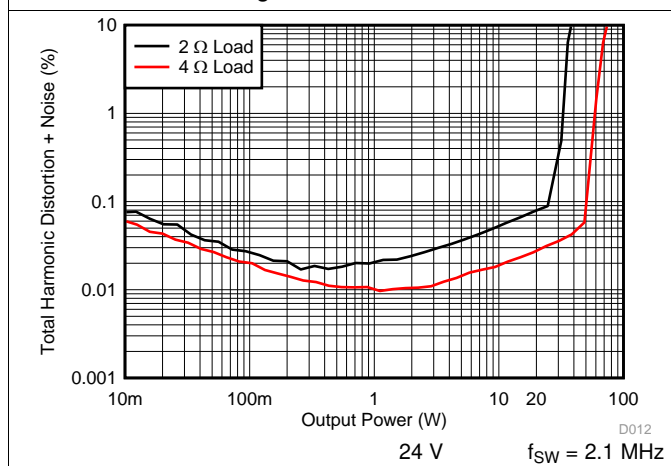

Figure 11. THD+N vs Power

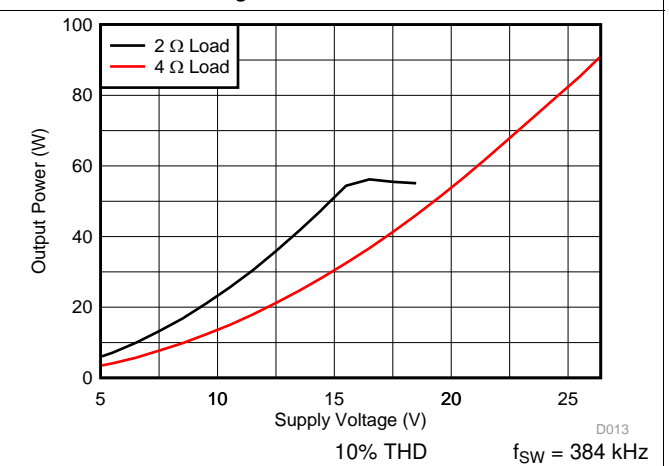

Figure 12. Output Power vs Supply Voltage

Typical Characteristics (continued)

$T_A = 25\text{ }^\circ\text{C}$ ,  $V_{DD} = 3.3\text{ V}$ ,  $V_{BAT} = PV_{DD} = 14.4\text{ V}$ ,  $R_L = 4\ \Omega$ ,  $f_{IN} = 1\text{ kHz}$ ,  $f_s = 48\text{ kHz}$ ,  $f_{SW} = 2.1\text{ MHz}$ , AES17 filter, default I<sup>2</sup>C settings, see Figure 77 (unless otherwise noted)

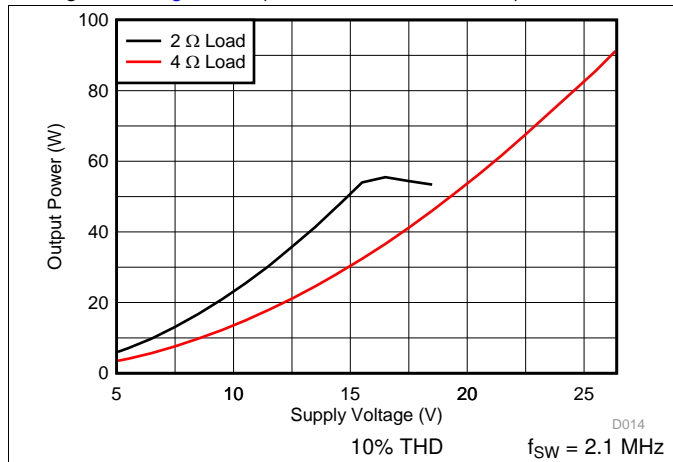

Figure 13. Output Power vs Supply Voltage

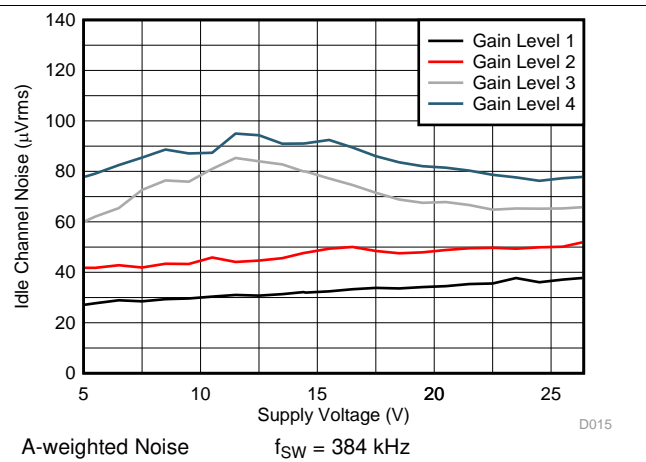

Figure 14. Noise vs Supply Voltage

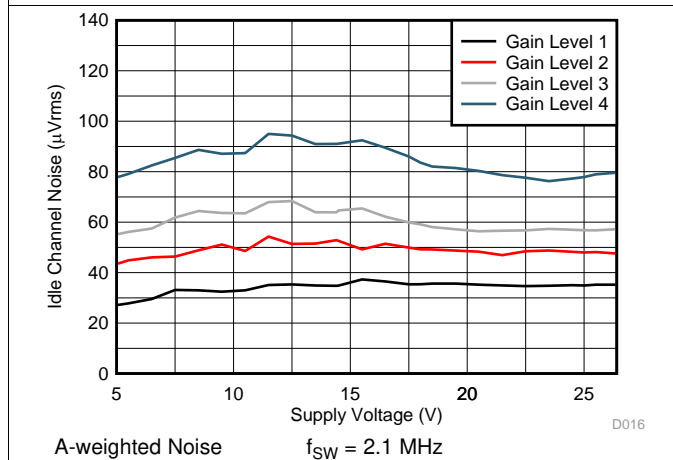

Figure 15. Noise vs Supply Voltage

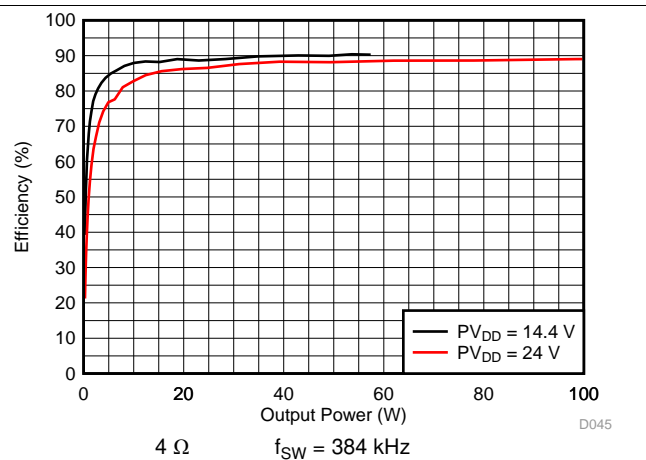

Figure 16. Power Efficiency vs Output Power

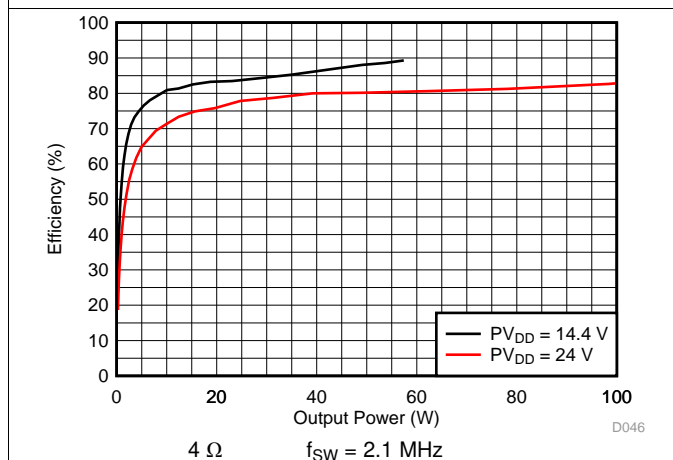

Figure 17. Power Efficiency vs Output Power

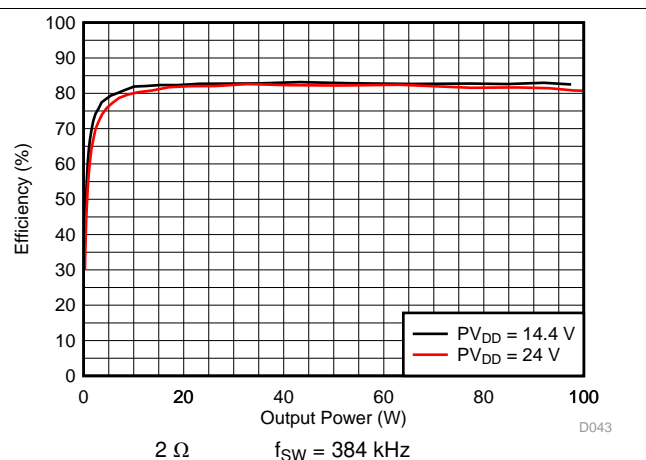

Figure 18. Power Efficiency vs Output Power

### Typical Characteristics (continued)

$T_A = 25\text{ }^\circ\text{C}$ ,  $V_{VDD} = 3.3\text{ V}$ ,  $V_{BAT} = PV_{DD} = 14.4\text{ V}$ ,  $R_L = 4\ \Omega$ ,  $f_{IN} = 1\text{ kHz}$ ,  $f_s = 48\text{ kHz}$ ,  $f_{SW} = 2.1\text{ MHz}$ , AES17 filter, default I<sup>2</sup>C settings, see [Figure 77](#) (unless otherwise noted)

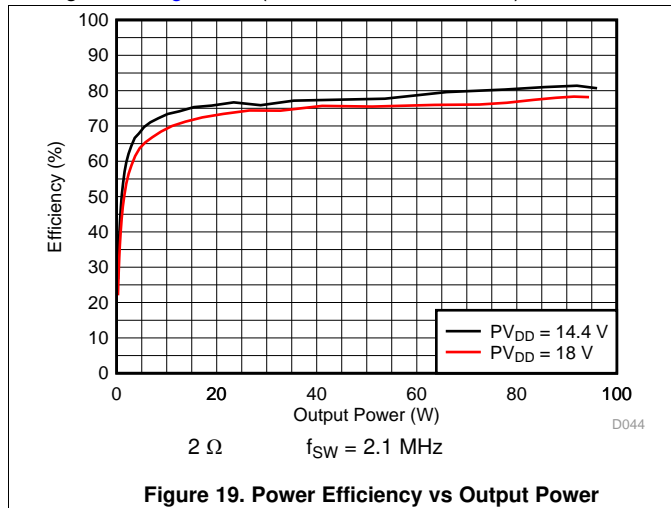

Figure 19. Power Efficiency vs Output Power

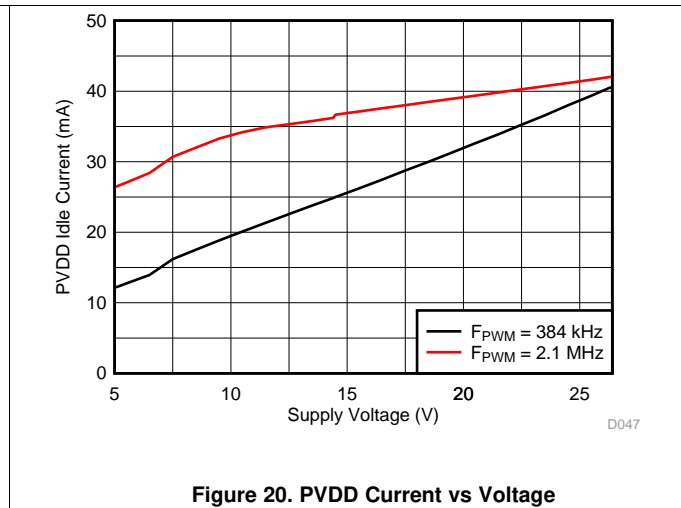

Figure 20. PVDD Current vs Voltage

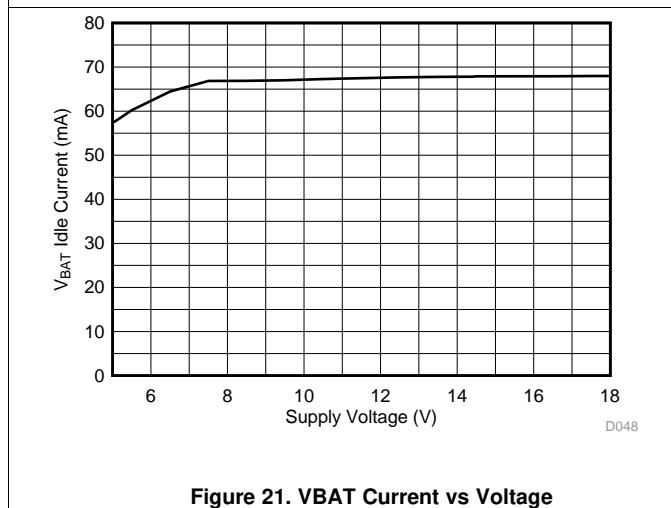

Figure 21. VBAT Current vs Voltage

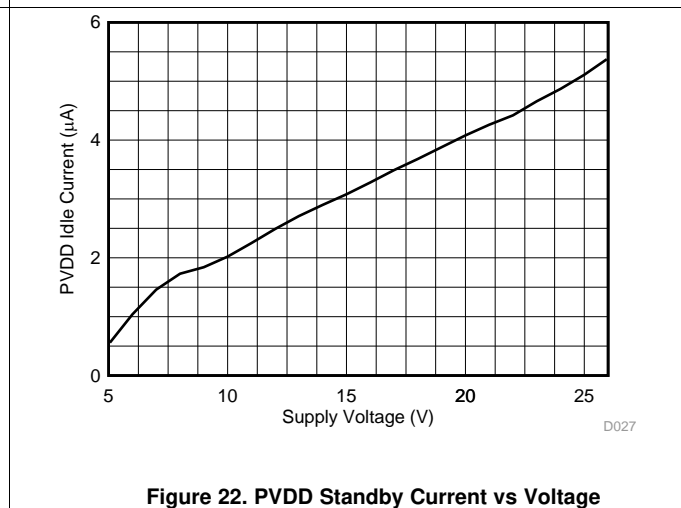

Figure 22. PVDD Standby Current vs Voltage

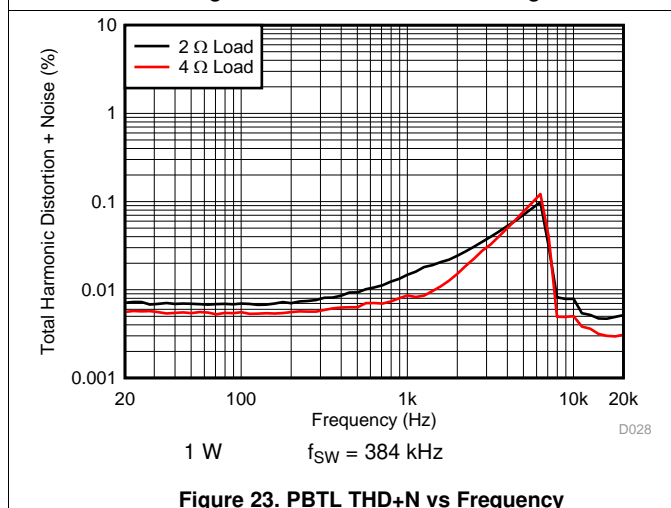

Figure 23. PBTLD THD+N vs Frequency

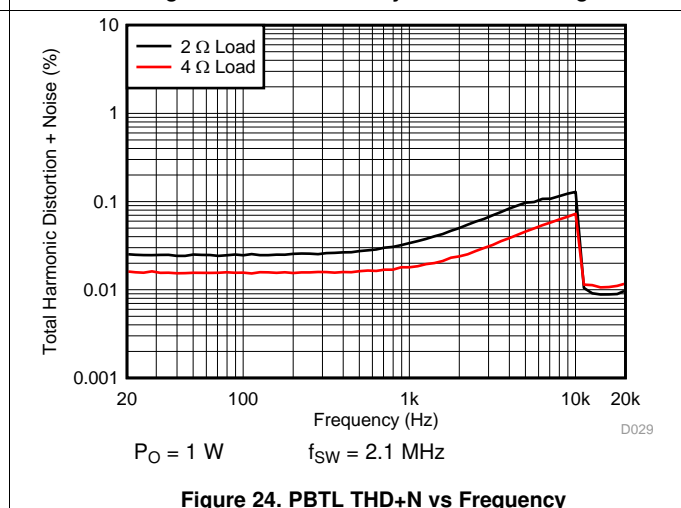
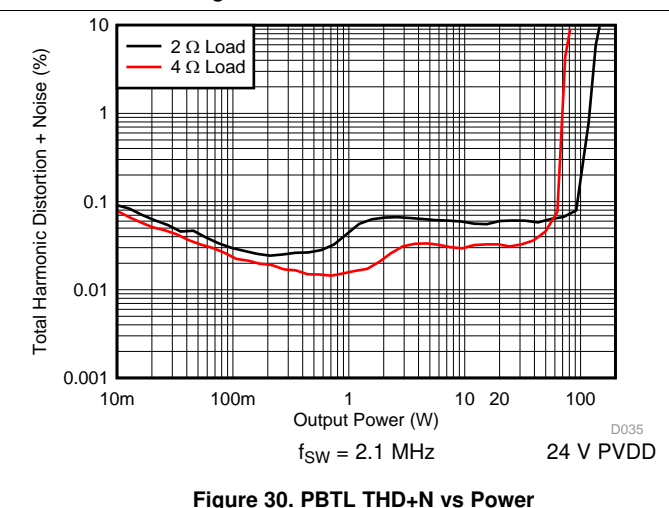
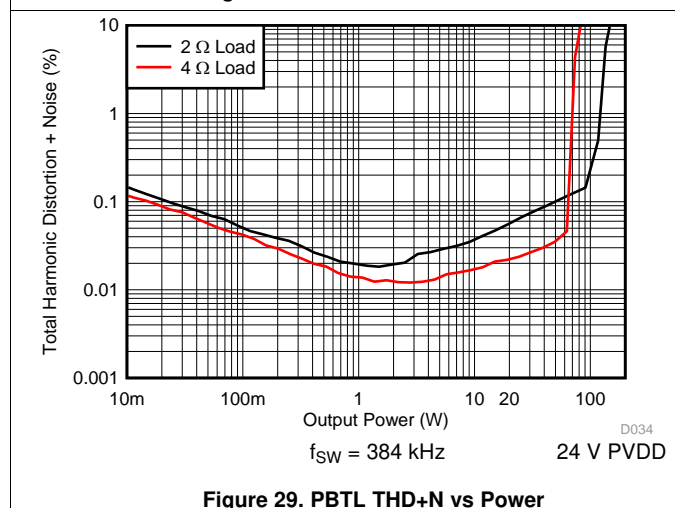
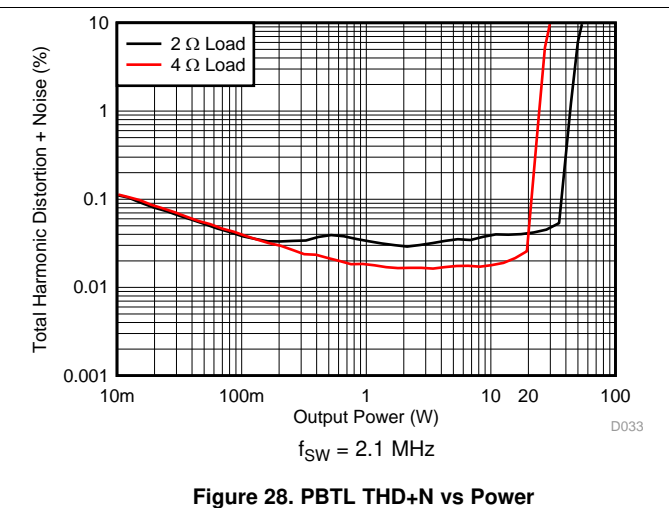
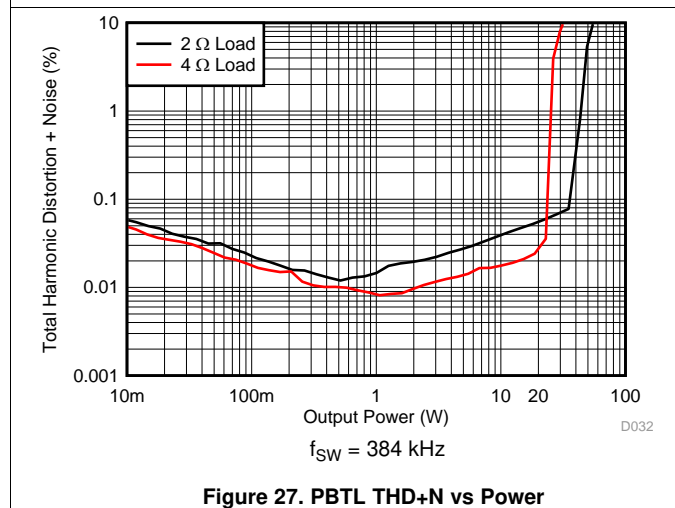
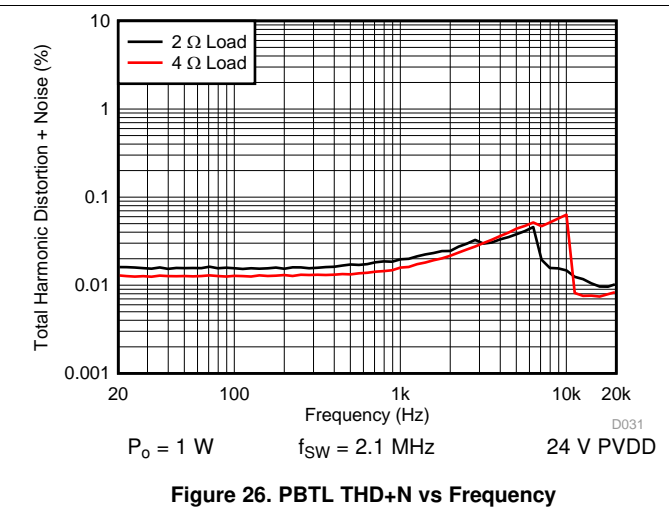
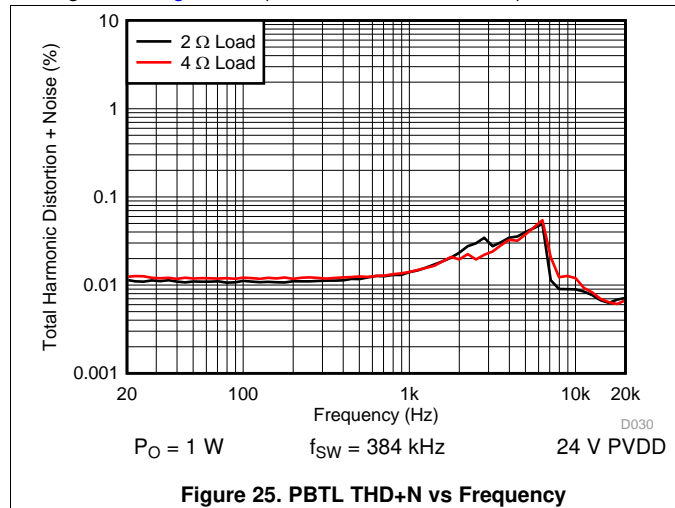

Figure 24. PBTLD THD+N vs Frequency

Typical Characteristics (continued)

$T_A = 25\text{ }^\circ\text{C}$ ,  $V_{VDD} = 3.3\text{ V}$ ,  $V_{BAT} = PVDD = 14.4\text{ V}$ ,  $R_L = 4\ \Omega$ ,  $f_{IN} = 1\text{ kHz}$ ,  $f_s = 48\text{ kHz}$ ,  $f_{SW} = 2.1\text{ MHz}$ , AES17 filter, default I<sup>2</sup>C settings, see Figure 77 (unless otherwise noted)



### Typical Characteristics (continued)

$T_A = 25\text{ }^\circ\text{C}$ ,  $V_{DD} = 3.3\text{ V}$ ,  $V_{BAT} = PV_{DD} = 14.4\text{ V}$ ,  $R_L = 4\ \Omega$ ,  $f_{IN} = 1\text{ kHz}$ ,  $f_s = 48\text{ kHz}$ ,  $f_{SW} = 2.1\text{ MHz}$ , AES17 filter, default I<sup>2</sup>C settings, see [Figure 77](#) (unless otherwise noted)

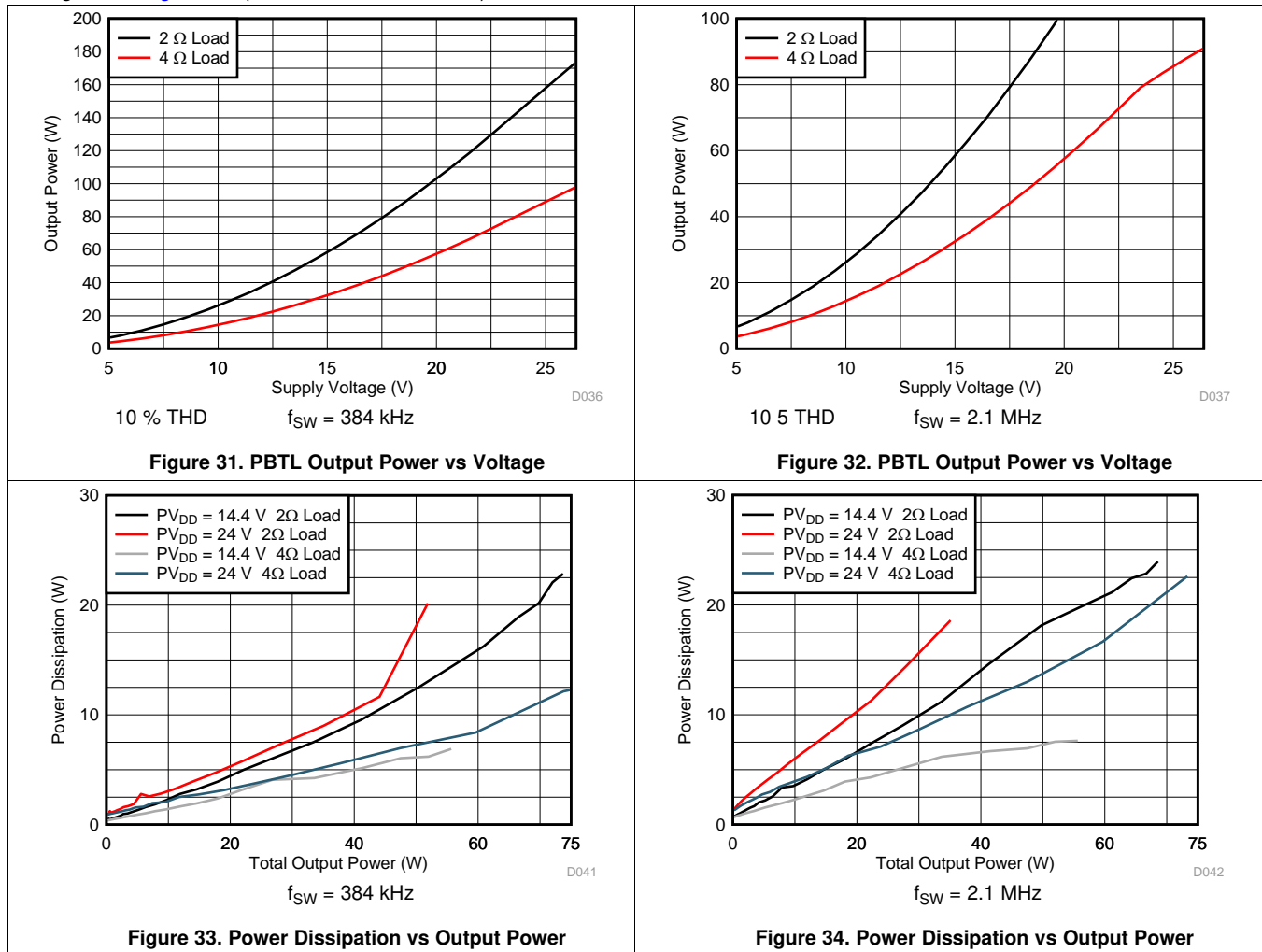

## 8 Parameter measurement Information

The parameters for the TAS6422-Q1 device were measured using the circuit in [Figure 77](#).



## 9 Detailed description

### 9.1 Overview

The TAS6422-Q1 device is a fourtwo-channel digital-input Class-D audio amplifier for use in the automotive environment. The device is designed for vehicle battery operation or boosted voltage systems. The design uses ultra-efficient class-D technology developed by Texas Instruments specifically tailored for the automotive industry. This technology allows for reduced power consumption, reduced PCB area, reduced heat, and reduced peak currents in the electrical system. The device realizes an audio sound-system design with smaller size and lower weight than traditional class-AB solutions.

The core design blocks are as follows:

- Serial audio port
- Clock management
- High-pass filter and volume control
- Pulse width modulator (PWM) with output stage feedback
- Gate drive
- Power FETs
- Diagnostics
- Protection
- Power supply
- I<sup>2</sup>C serial communication bus

### 9.2 Functional Block Diagram

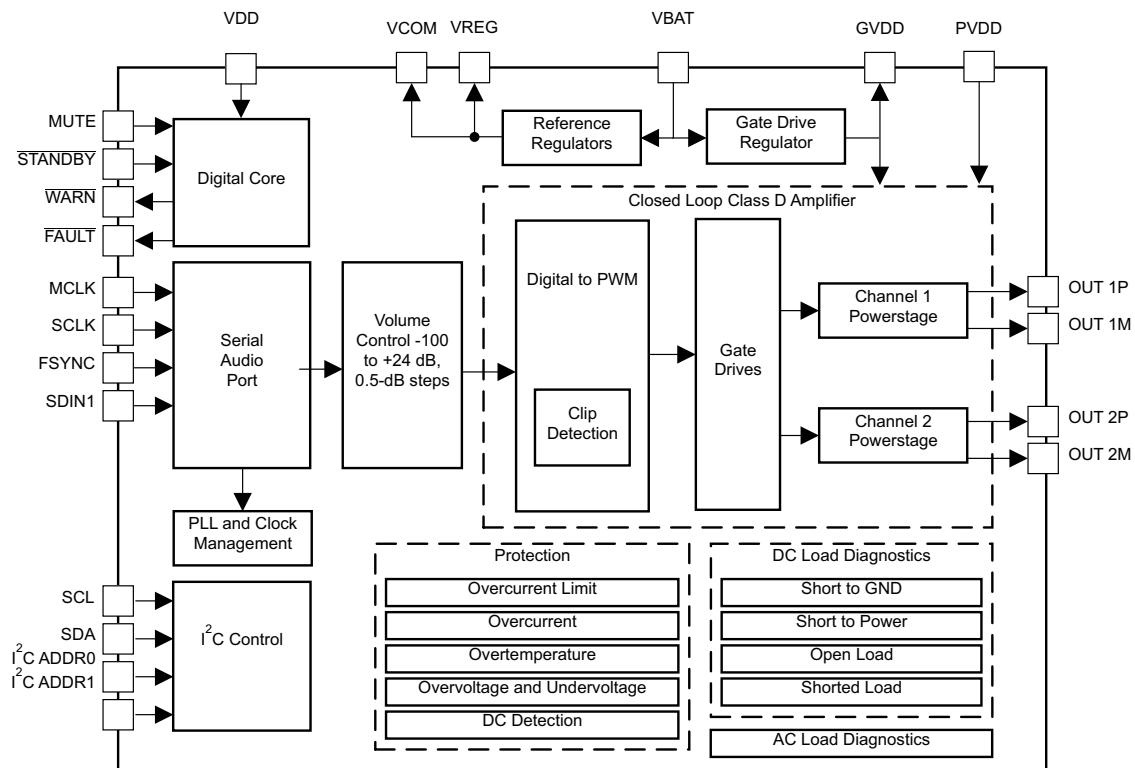

## 9.3 Feature Description

### 9.3.1 Serial Audio Port

The serial audio port (SAP) receives audio in either I<sup>2</sup>S, left justified, right justified, or TDM formats.

Settings for the serial audio port are programmed in the SAP control register (address 0x03), see the [SAP Control \(Serial Audio-Port Control\) Register \(address = 0x03\) \[default = 0x04\]](#) section.

Figure 35 shows the digital audio data connections for I<sup>2</sup>S and TDM8 mode for an six channel system.

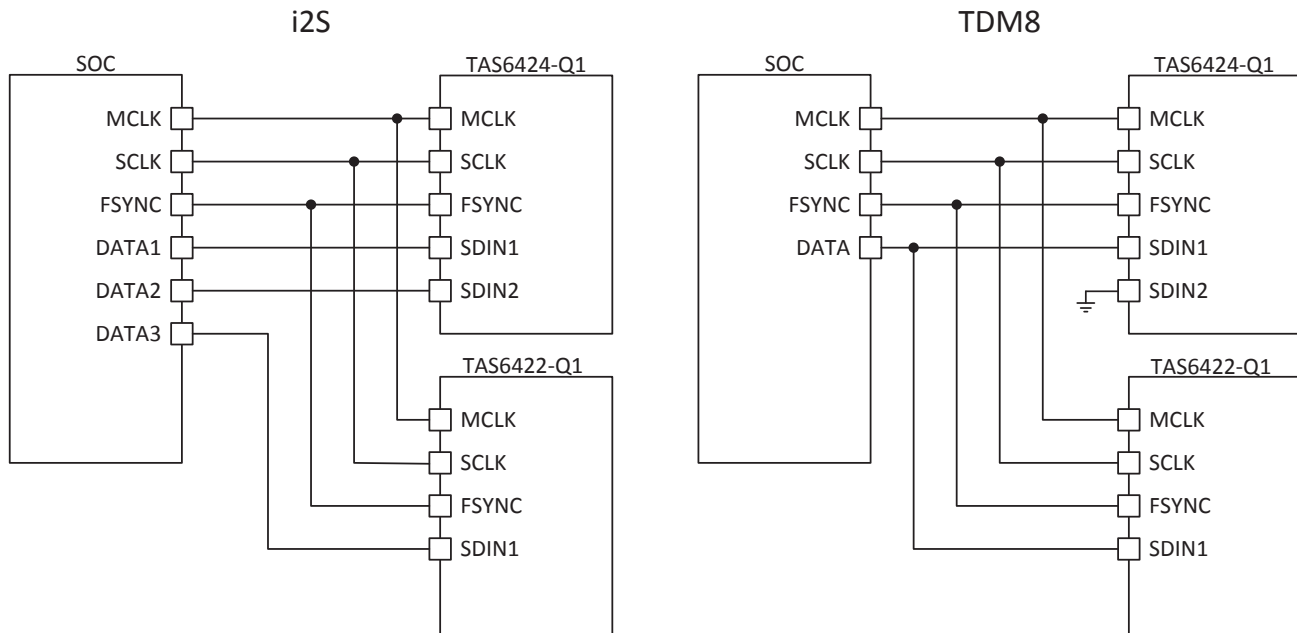

**Figure 35. Digital-Audio Data Connection**

#### 9.3.1.1 I<sup>2</sup>S Mode

I<sup>2</sup>S timing uses the FSYNC pin to define when the data being transmitted is for the left channel and when the data is for the right channel. The FSYNC pin is low for the left channel and high for the right channel. The bit clock, SCLK, runs at  $32$  or  $64 \times f_s$  and is used to clock in the data. A delay of one bit clock occurs from the time the FSYNC signal changes state to the first bit of data on the data lines. The data is presented in 2s-complement form (MSB-first). The data is valid on the rising edge of the bit clock and is used to clock in the data.

#### 9.3.1.2 Left-Justified Timing

Left-justified (LJ) timing also uses the FSYNC pin to define when the data being transmitted is for the left channel and when the data is for the right channel. The FSYNC pin is high for the left channel and low for the right channel. A bit clock running at  $32$  or  $64 \times f_s$  is used to clock in the data. The first bit of data appears on the data lines at the same time FSYNC toggles. The data is written MSB-first and is valid on the rising edge of the bit clock. Digital words can be 16-bits or 24-bits wide and pad any unused trailing data-bit positions in the left-right (L/R) frame with zeros.

#### 9.3.1.3 Right-Justified Timing

Right-justified (RJ) timing also uses the FSYNC pin to define when the data being transmitted is for the left channel and when the data is for the right channel. The FSYNC pin is high for the left channel and low for the right channel. A bit clock running at  $32$  or  $64 \times f_s$  is used to clock in the data. The first bit of data appears on the data 8-bit clock periods (for 24-bit data) after the FSYNC pin toggles. In RJ mode the LSB of data is always clocked by the last bit clock before the FSYNC pin transitions. The data is written MSB-first and is valid on the rising edge of bit clock. The device pads the unused leading data-bit positions in the L/R frame with zeros.

## Feature Description (continued)

### 9.3.1.4 TDM Mode

TDM mode supports 4 or 8 channels of audio data. The TDM mode is automatically selected when the TDM clocks are present. The device can be configured through I<sup>2</sup>C to use different stereo pairs in the TDM data stream. The TDM mode supports 16-bit, 24-bit, and 32-bit input data lengths.

In TDM mode, the SCLK pin must be 128 or 256, depending on the TDM slot size. In TDM mode SCLK and MCLK can be connected together. If SCLK and MCLK are connected together than FSYNC should be minimum 2 MCLK pulses long.

In TDM mode, the SDIN1 pin (pin 15) is used for digital audio data. TI recommends to connect the unused SDIN2 pin (pin 16) to ground. [Table 1](#) lists register settings for the TDM channel selection.

**Table 1. TDM Channel Selection**

REGISTER SETTING		TDM8 CHANNEL SLOT							
0x03 BIT 5	0x03 BIT 3	1	2	3	4	5	6	7	8
0	0	CH1	CH2	-	-	—	—	—	—
1	0	—	—	—	—	CH1	CH2	-	-
0	1	-	-	CH1	CH2	—	—	—	—
1	1	—	—	—	—	-	-	CH1	CH2

If PBTL mode is programmed for channel 1/2 the datasource can be set according to [Table 2](#).

**Table 2. TDM Channel Selection in PBTL Mode**

REGISTER SETTING			TDM8 CHANNEL SLOT							
0x03 BIT 5	0x03 BIT 3	0x21 BIT 6	1	2	3	4	5	6	7	8
0	0	0	PBTL CH1/2	—	-	—	—	—	—	—
1	0	0	—	—	—	—	PBTL CH1/2	—	-	—
0	0	1	—	PBTL CH1/2	—	-	—	—	—	—
1	0	1	—	—	—	—	—	PBTL CH1/2	—	-
0	1	0	-	—	PBTL CH1/2	—	—	—	—	—
1	1	0	—	—	—	—	-	—	PBTL CH1/2	—
0	1	1	—	-	—	PBTL CH1/2	—	—	—	—
1	1	1	—	—	—	—	—	-	—	PBTL CH1/2

### 9.3.1.5 Supported Clock Rates

The device supports MCLK rates of  $128 \times f_s$ ,  $256 \times f_s$ , or  $512 \times f_s$ .

The device supports SCLK rates of  $32$  or  $64 \times f_s$  in I2S, LJ or RJ modes or  $128 \times f_s$ , or  $256 \times f_s$  in TDM mode.

The device supports FSYNC rates of 44.1 kHz, 48 kHz, or 96 kHz.

The maximum clock frequency is 25 MHz. Therefore, for a 96-kHz FSYNC rate, the maximum MCLK rate is  $256 \times f_s$ .

The MCLK clock must not be in phase to sync to SCLK. Duty cycle of 50% is required for  $128 \times f_s$ , for  $256 \times f_s$  and  $512 \times f_s$  50% duty is not required.

### 9.3.1.6 Audio-Clock Error Handling

When any kind of clock error, MCLK-FSYNC or SCLK-FSYNC ratio, or clock halt is detected, the device puts all channels into the Hi-Z state. When all audio clocks are within the expected range, the device automatically returns to the state it was in. See the [Timing Requirements](#) table for timing requirements.

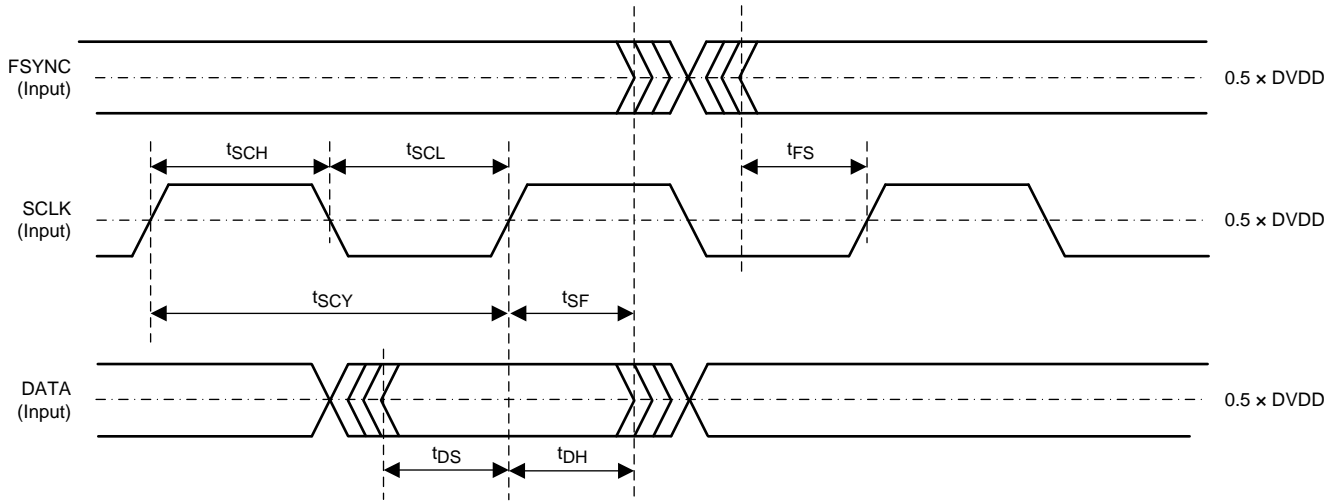

Figure 36. Serial Audio Timing

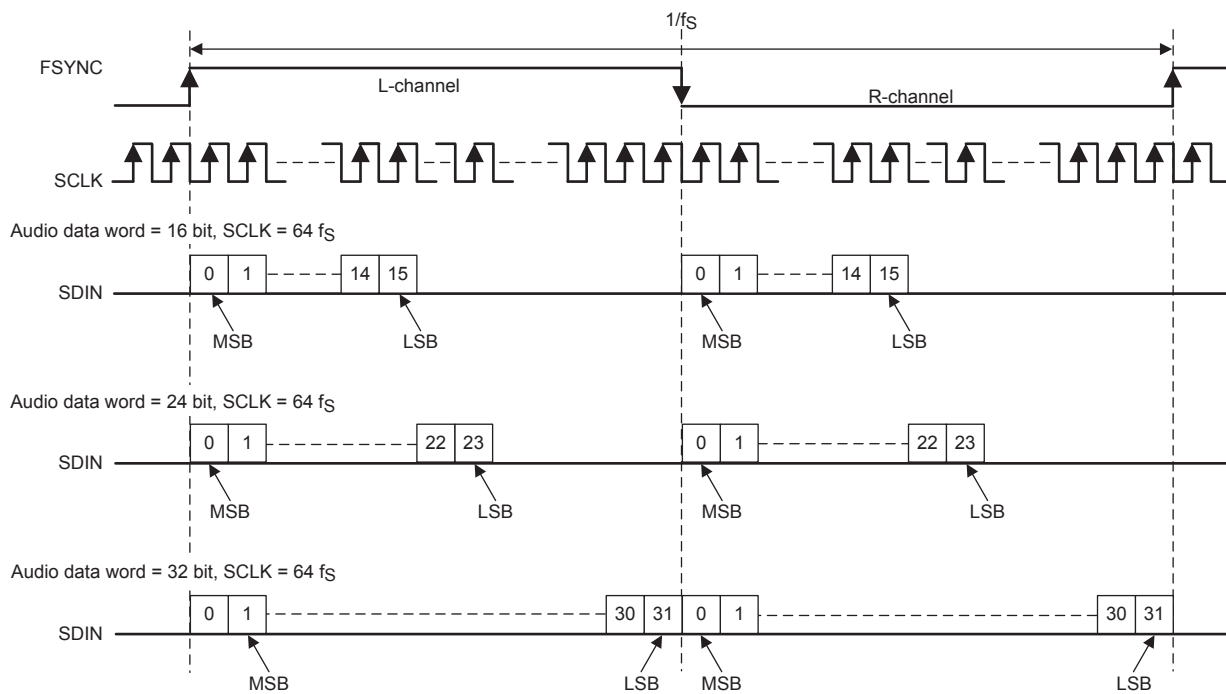

Figure 37. Left-Justified Audio Data Format

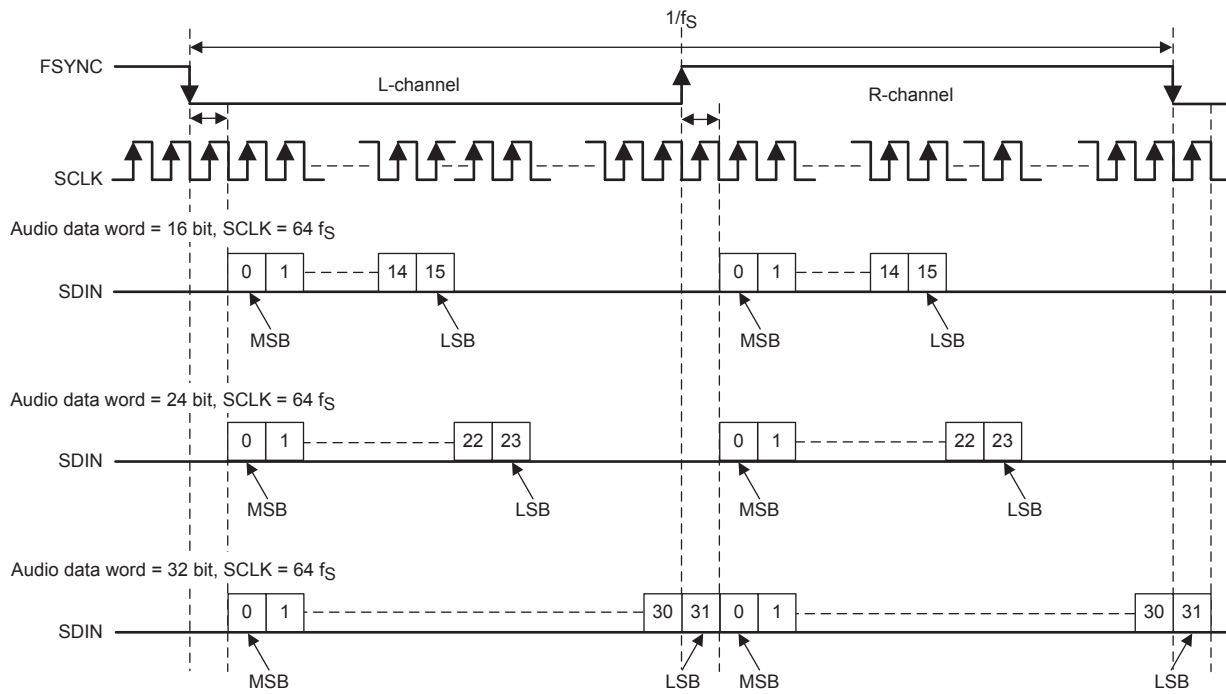
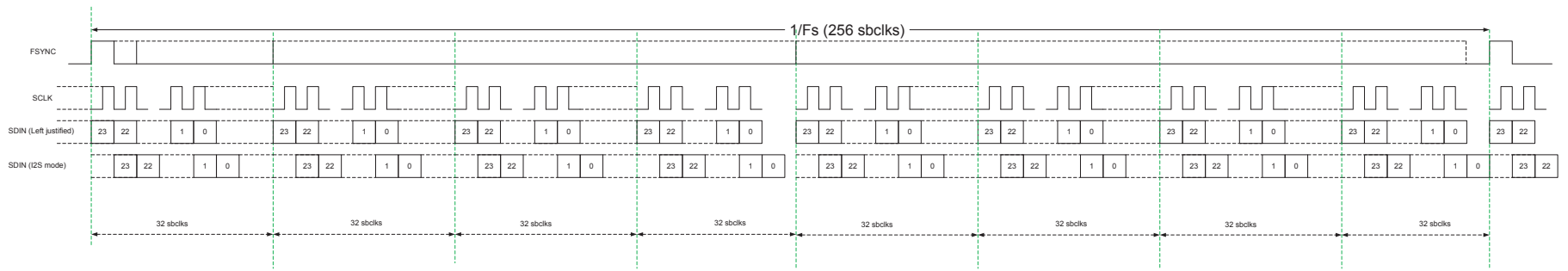

Figure 38. I<sup>2</sup>S Audio Data Format



Audio Data Format: TDM8 mode

**Figure 39. TDM8 Audio Data Format**

### 9.3.2 High-Pass Filter

Direct-current (DC) content in the audio signal can damage speakers. The data path has a high-pass filter to remove any DC from the input signal. The corner frequency is selectable from 4 Hz, 8 Hz, or 15 Hz to 30 Hz with bits 0 through 3 in register 0x26. The default value of –3 dB is approximately 4 Hz for 44.1 kHz or 48 kHz and approximately 8 Hz for 96-kHz sampling rates.

### 9.3.3 Volume Control and Gain

Each channel has a independent digital-volume control with a range from –100 dB to +24 dB with 0.5-dB steps. The volume control is set through I<sup>2</sup>C. The gain-ramp rate is programmable through I<sup>2</sup>C to take one step every 1, 2, 4, or 8 FSYNC cycles.

The peak output-voltage swing is also configurable in the gain control register through I<sup>2</sup>C. The four gain settings are 7.5 V, 15 V, 21 V, and 29 V. TI recommends selecting the lowest possible for the expected PVDD operation to optimize output noise and dynamic range performance.

### 9.3.4 High-Frequency Pulse-Width Modulator (PWM)

The PWM converts the PCM input data into a switched signal of varying duty cycle. The PWM modulator is an advanced design with high bandwidth, low noise, low distortion, and excellent stability. The output switching rate is synchronous to the serial audio-clock input and is programmed through I<sup>2</sup>C to be between 8× and 48× the input-sample rate. The option to switch at high frequency allows the use of smaller and lower cost external filtering components. [Table 3](#) lists the switch frequency options for bits 4 through 6 in the miscellaneous control 2 register (address 0x02).

**Table 3. Output Switch Frequency Option**

INPUT SAMPLE RATE	BIT 6:4 SETTINGS					
	000	001	010 to 100	101	110	111
44.1 kHz	352.8 kHz	441 kHz	RESERVED	1.68 MHz	1.94 MHz	2.12 MHz
48 kHz	384 kHz	480 kHz	RESERVED	1.82 MHz	2.11 MHz	Not supported
96 kHz	384 kHz	480 kHz	RESERVED	1.82 MHz	2.11 MHz	Not supported

### 9.3.5 Gate Drive

The gate driver accepts the low-voltage PWM signal and level shifts it to drive a high-current, full-bridge, power-FET stage. The device uses proprietary techniques to optimize EMI and audio performance.

The gate-driver power-supply voltage, GVDD, is internally generated and a decoupling capacitor is connected at pin 9 and pin 10.

The full H-bridge output stages use only NMOS transistors. Therefore, bootstrap capacitors are required for the proper operation of the high side NMOS transistors. A 1-μF ceramic capacitor of quality X7R or better, rated for at least 16 V, must be connected from each output to the corresponding bootstrap input (see the application circuit diagram in [Figure 77](#)). The bootstrap capacitors connected between the BST pins and corresponding output function as a floating power supply for the high-side N-channel power MOSFET gate drive circuitry. During each high-side switching cycle, the bootstrap capacitors hold the gate-to-source voltage high keeping the high-side MOSFETs turned on.

### 9.3.6 Power FETs

The BTL output for each channel comprises four N-channel 90-mΩ FETs for high efficiency and maximum power transfer to the load. These FETs are designed to handle the fast switching frequency and large voltage transients during load dump.

### 9.3.7 Load Diagnostics

The device incorporates both DC-load and AC-load diagnostics which are used to determine the status of the load. The DC diagnostics are turned on by default but if a fast startup without diagnostics is required the DC diagnostics can be bypassed through I<sup>2</sup>C. The DC diagnostics runs when any channel is directed to leave the Hi-Z state and enter the MUTE or PLAY state. The DC diagnostics can also be enabled manually to run on any or all channels even if the other channels are playing audio. DC Diagnostics can be started from any operating

condition but if the channel is in play state then the time to complete the diagnostic is longer because the device must ramp down the audio signal of that channel before transitioning to the Hi-Z state. The DC diagnostics are available as soon as the device supplies are within the recommended operating range. The DC diagnostics do not rely on the audio input clocks to be available to function. DC Diagnostic results are reported for each channel separately through the I<sup>2</sup>C registers.

### 9.3.7.1 DC Load Diagnostics

The DC load diagnostics are used to verify the load connected. The DC diagnostics consists of four tests: short-to-power (S2P), short-to-ground (S2G), open-load (OL), and shorted-load (SL). The S2P and S2G tests trigger if the impedance to GND or a power rail is below that specified in the [Specifications](#) section. The diagnostic detects a short to vehicle battery even when the supply is boosted. The SL test has an I<sup>2</sup>C-configurable threshold depending on the expected load to be connected. Because the speakers connected to each channel might be different, each channel can be assigned a unique threshold value. The OL test reports if the select channel has a load impedance greater than the limits in the [Specifications](#) section.

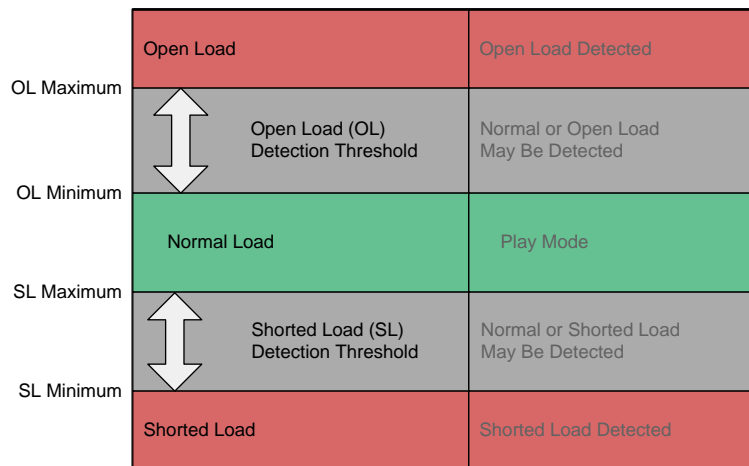

**Figure 40. DC Load Diagnostic Reporting Thresholds**

### 9.3.7.2 Line Output Diagnostics

The device also includes an optional test to detect a line-output load. A line-output load is a high-impedance load that is above the open-load (OL) threshold such that the DC-load diagnostics report an OL condition. After an OL condition is detected on a channel, if the line output detection bit is also set, the channel checks if a line-output load is present as well. This test is not pop free, so if an external amplifier is connected it should be muted.

### 9.3.7.3 AC Load Diagnostics

The AC load diagnostic is used to determine the proper connection of a capacitively coupled speaker or tweeter when used with a passive crossover. The AC load diagnostic is controlled through I<sup>2</sup>C. The AC diagnostics requires an external input signal and reports the approximate load impedance and phase. The selected signal frequency should create current flow through the desired speaker for proper detection. If multiple channels must be tested, the diagnostics should be run in series. The AC load-diagnostic test procedure is as follows.

For load-impedance detection, use the following test procedure:

1. Set the channels to be tested into the Hi-Z state.
2. Set the AC\_DIAGS\_LOOPBACK bit (bit 7 in register 0x16) to 0.
3. Apply a full-scale input signal from the DSP for the tested channels with the desired frequency (recommended 10 kHz to 20 kHz).

#### NOTE

The device ramps the signal up and down automatically to prevent pops and clicks.

4. Set the device into the AC diagnostic mode (set bits 3:0 in register 0x15 to 1 for CH1 and CH2, set bit 3 in register 0x15 to 1, and set bit 1 in register 0x15 to 1 for PBT12).



## 5. Read back the AC impedance (register 0x17 through register 0x1A).

When the test is complete the channel reporting register indicates the status change from the AC diagnostic mode to the Hi-Z state. The detected impedance is stored in the appropriate I<sup>2</sup>C register.

For loopback delay detection, use the following test procedure for either BTL mode or PBTL mode:

- BTL mode

- Set the AC\_DIAGS\_LOOPBACK bit (bit 7 in register 0x16) to 1 to enable AC loopback mode.
- Apply a 0-dBFS 19K signal and enable AC load diagnostics. CH1 and CH2 reuse the AC sensing loop of CH1 (set bit 3 in register 0x15 to 1).
- Read back the AC\_LDG\_PHASE1 value (register 0x1B and register 0x1C).

When the test is complete, the channel reporting register indicates the status change from the AC diagnostic mode to the Hi-Z state. The detected impedance is stored in the appropriate I<sup>2</sup>C register.

- PBTL mode

- Set the AC\_DIAGS\_LOOPBACK bit (bit 7 in register 0x16) to 1 to enable AC loopback mode.
- Set the PBTL CH12 bits (see register 0x00) to 0 without toggling SDz pin to enter BTL mode only for load diagnostics.
- Apply a 0-dBFS 19K signal and enable AC load diagnostics. For PBTL\_12, enable the AC sensing loop of CH1 (set bit 3 in register 0x15 to 1).
- Read back the AC\_LDG\_PHASE1 (register 0x1B and register 0x1C).
- Set the PBTL CH12 bits (see register 0x00) to 1 to go back to PBTL mode for load diagnostics.

**Table 4. AC Impedance Code to Magnitude**

SETTING	GAIN AT 19 kHz	I(A)	MEASUREMENT RANGE (Ω)	MAPPING FROM CODE TO MAGNITUDE (Ω/Code)
Gain = 4, I = 10 mA (recommended)	4.28	0.01	12	0.05832
Gain = 4, I = 19 mA	4.28	0.019	6	0.0307
Gain = 1, I = 10 mA (recommended)	1	0.01	48	0.2496
Gain = 1, I = 19 mA	1	0.019	24	0.1314

### 9.3.8 Protection and Monitoring

#### 9.3.8.1 Overcurrent Limit ( $I_{LIMIT}$ )

The overcurrent limit terminates each PWM pulse to limit the output current flow when the current limit ( $I_{LIMIT}$ ) is exceeded. Power is limited but operation continues without disruption and prevents undesired shutdown for transient music events.  $I_{LIMIT}$  is not reported as a fault condition to either registers or the  $\overline{FAULT}$  pin. Each channel is independently monitored and limited. The two programmable levels can be set by bit 4 in the miscellaneous control 1 register (address 0x01).

#### 9.3.8.2 Overcurrent Shutdown ( $I_{SD}$ )

If the output load current reaches  $I_{SD}$ , such as an output short to GND, then a peak current limit occurs which shuts down the channel. The time to shutdown the channel varies depending on the severity of the short condition. The affected channel is placed into the Hi-Z state, the fault is reported to the register, and the  $\overline{FAULT}$  pin is asserted. If the diagnostics are enabled then the device automatically starts diagnostics on the channel and, if no load failure is found, the device restarts. If a load fault is found the device continues to rerun the diagnostics once per second. Because this hiccup mode is using the diagnostics, no high current is created. If the diagnostics are disabled the device sets the state for that channel to Hi-Z and requires the MCU to take the appropriate action.

Two programmable levels can be set by bit 4 in the miscellaneous control 1 register (address 0x01).

### 9.3.8.3 DC Detect

This circuit detects a DC offset continuously during normal operation at the output of the amplifier. If the DC offset exceeds the threshold, that channel is placed in the Hi-Z state, the fault is reported to the I<sup>2</sup>C register, and the FAULT pin is asserted. A register bit can be used to mask reporting to the FAULT pin if required.

### 9.3.8.4 Clip Detect

The clip detect is reported on the  $\overline{\text{WARN}}$  pin if 100% duty-cycle PWM is reached for a minimum of 20 cycles. If any channel is clipping, the clipping is reported to the pin. The clip detect is latched and can be cleared by I<sup>2</sup>C. Masking the clip reporting to the pin is possible through I<sup>2</sup>C.

### 9.3.8.5 Global Overtemperature Warning (OTW), Overtemperature Shutdown (OTSD)

Four overtemperature warning levels are available in the device that can be selected (see the [Register Maps](#) section for thresholds). When the junction temperature exceeds the warning level, the  $\overline{\text{WARN}}$  pin is asserted unless the mask bit has been set to disable reporting. The device functions until the OTSD value is reached at which point all channels are placed in the Hi-Z state and the FAULT pin is asserted. When the junction temperature returns to normal levels, the device automatically recovers and places all channels into the state indicated by the register settings.

### 9.3.8.6 Channel Overtemperature Warning [OTW(i)] and Shutdown [OTSD(i)]

In addition to the global OTW, each channel also has an individual overtemperature warning and shutdown. If a channel exceeds the OTW(i) threshold, the warning register bit is set as the  $\overline{\text{WARN}}$  pin is asserted unless the mask bit has been set to disable reporting. If the channel temperature exceeds the OTSD(i) threshold then that channel goes to the Hi-Z state until the temperature drops below the OTW(i) threshold at which point the channel goes to the state indicated by the state control register.

### 9.3.8.7 Undervoltage (UV) and Power-On-Reset (POR)

The undervoltage (UV) protection detects low voltages on the PVDD and VBAT pins. In the event of an UV condition, the FAULT pin is asserted and the I<sup>2</sup>C register is updated. A power-on reset (POR) on the VDD pin causes the I<sup>2</sup>C to go to the high-impedance (Hi-Z) state and all registers are reset to default values. At power-on or after a POR event, the POR warning bit and  $\overline{\text{WARN}}$  pin are asserted.

### 9.3.8.8 Overvoltage (OV) and Load Dump

The overvoltage (OV) protection detects high voltages on the PVDD pin. If the PVDD pin reaches the OV threshold, the FAULT pin is asserted and the I<sup>2</sup>C register is updated. The device can withstand 40-V load-dump voltage spikes.

## 9.3.9 Power Supply

The device has three power supply inputs, VDD, PVDD, and VBAT, which are described as follows:

- VDD** This pin is a 3.3-V supply pin that provides power to the low voltage circuitry.
- VBAT** This pin is a higher voltage supply that can be connected to the vehicle battery or the regulated voltage rail in a boosted system within the recommended limits. For best performance, this rail should be 10 V or higher. See the [Recommended Operating Conditions](#) table for the maximum supply voltage. This supply rail is used for higher voltage analog circuits but not the output FETs.
- PVDD** This pin is a high-voltage supply that can either be connected to the vehicle battery or to another voltage rail in a boosted system. The PVDD pin supplies the power to the output FETs and can be within the recommended operating limits, even if that is below the VBAT supply, to allow for dynamic voltage systems.

Several on-chip regulators are included generating the voltages necessary for the internal circuitry. The external pins are provided only for bypass capacitors to filter the supply and should not be used to power other circuits.

The device can withstand fortuitous open ground and power conditions within the absolute maximum ratings for the device. Fortuitous open ground usually occurs when a speaker wire is shorted to ground, allowing for a second ground path through the body diode in the output FETs.

### 9.3.9.1 Vehicle-Battery Power-Supply Sequence

The device can accept any sequence of the VBAT, PVDD and VDD supply.

In a typical system, the VBAT and PVDD supplies are both connected to the vehicle battery and power up at the same time. The VDD supply should be applied after the VBAT and PVDD supplies are within the recommended operating range. When removing power from the device, TI recommends to deassert the VDD supply first then the VBAT, PVDD, or both supplies which provides the lowest click and pop performance.

### 9.3.9.2 Boosted Power-Supply Sequence

In this case, the VBAT and PVDD inputs are not connected to the same supply.

When powering up, apply the VBAT supply first, the VDD supply second, and the PVDD supply last.

When powering down, remove the PVDD supply first, the VDD supply second, and the VBAT supply last.

### 9.3.10 Hardware Control Pins

The device has four pins for control and device status:  $\overline{\text{FAULT}}$ ,  $\overline{\text{MUTE}}$ ,  $\overline{\text{WARN}}$ , and  $\overline{\text{STANDBY}}$ .

#### 9.3.10.1 $\overline{\text{FAULT}}$

The  $\overline{\text{FAULT}}$  pin reports faults and is active low under any of the following conditions:

- Any channel faults (overcurrent or DC detection)
- Overtemperature shutdown
- Overvoltage or undervoltage conditions on the VBAT or PVDD pins
- Clock errors

The  $\overline{\text{FAULT}}$  pin is deactivated when none of the previously listed conditions exist.

Register bits are available to mask fault categories from reporting to the  $\overline{\text{FAULT}}$  pin. These bits only mask the setting of the pin and do not affect the register reporting or protection of the device. By default all faults are reported to the pin. See the [Register Maps](#) section for a description of the mask settings.

This pin is an open-drain output with an internal 100-k $\Omega$  pullup resistor to VDD.

#### 9.3.10.2 $\overline{\text{WARN}}$

This active-low output pin reports audio clipping, overtemperature warnings, and POR events.

Clipping is reported if any channel is at the maximum modulation for 20 consecutive PWM clocks which results in a 10- $\mu$ s delay to report the onset of clipping. The warning bit is sticky and can be cleared by the CLEAR FAULT bit (bit 7) in register 0x21.

An overtemperature warning (OTW) is reported if the general temperature or any of the channel temperature warnings are set. The warning temperature can be set through bits 5 and 6 in register 0x01.

Register bits are available to mask either clipping or OTW reporting to the pin. These bits only mask the setting of the pin and do not affect the register reporting. By default both clipping and OTW are reported.

The  $\overline{\text{WARN}}$  pin is latched and can be cleared by writing the CLEAR FAULT bit (bit 7) in register 0x21.

This pin is an open-drain output with an internal 100-k $\Omega$  pullup resistor to VDD.

#### 9.3.10.3 $\overline{\text{MUTE}}$

This active-low input pin is used for hardware control of the mute and unmute function for all channels.

This pin has a 100-k $\Omega$  internal pulldown resistor.

#### 9.3.10.4 $\overline{\text{STANDBY}}$

When this active-low input pin is asserted, the device goes into shutdown and current draw is limited. This pin can be used to shut down the device rapidly. The outputs are ramped down in less than 5 ms if the device is not already in the Hi-Z state. The I<sup>2</sup>C bus goes into the high-impedance (Hi-Z) state when in  $\overline{\text{STANDBY}}$ .

This pin has a 100-k $\Omega$  internal pulldown resistor.

## 9.4 Device Functional Modes

### 9.4.1 Operating Modes and Faults

The operating modes and faults are listed in the following tables.

**Table 5. Operating Modes**

STATE NAME	OUTPUT FETS	OSCILLATOR	I <sup>2</sup> C
STANDBY	Hi-Z	Stopped	Stopped
Hi-Z	Hi-Z	Active	Active
MUTE	Switching at 50%	Active	Active
PLAY	Switching with audio	Active	Active

**Table 6. Global Faults and Actions**

FAULT/ EVENT	FAULT/EVENT CATEGORY	MONITORING MODES	REPORTING METHOD	ACTION RESULT
POR	Voltage fault	All	I <sup>2</sup> C + $\overline{\text{WARN}}$ pin	Standby
VBAT UV		Hi-Z, mute, normal	I <sup>2</sup> C + $\overline{\text{FAULT}}$ pin	Hi-Z
PVDD UV				
VBAT or PVDD OV				
OTW	Thermal warning	Hi-Z, mute, normal	I <sup>2</sup> C + $\overline{\text{WARN}}$ pin	None
OTSD	Thermal shutdown	Hi-Z, mute, normal	I <sup>2</sup> C + $\overline{\text{FAULT}}$ pin	Hi-Z

**Table 7. Channel Faults and Actions**

FAULT/ EVENT	FAULT/EVENT CATEGORY	MONITORING MODES	REPORTING METHOD	ACTION TYPE
Clipping	Warning	Mute and play	$\overline{\text{WARN}}$ pin	None
Overcurrent limiting	Protection			Current limit
Overcurrent fault	Output channel fault		I <sup>2</sup> C + $\overline{\text{FAULT}}$ pin	Hi-Z
DC detect				

## 9.5 Programming

### 9.5.1 I<sup>2</sup>C Serial Communication Bus

The device communicates with the system processor through the I<sup>2</sup>C serial communication bus as an I<sup>2</sup>C slave-only device. The processor can poll the device through I<sup>2</sup>C to determine the operating status, configure settings, or run diagnostics. For a complete list and description of all I<sup>2</sup>C controls, see the [Register Maps](#) section.

The device includes two I<sup>2</sup>C address pins, so up to four devices can be used together in a system with no additional bus switching hardware. The I<sup>2</sup>C ADDR<sub>x</sub> pins set the slave address of the device as listed in [Table 8](#).

**Table 8. I<sup>2</sup>C Addresses**

DESCRIPTION	I <sup>2</sup> C ADDR1	I <sup>2</sup> C ADDR0	I <sup>2</sup> C Write	I <sup>2</sup> C Read
Device 0	0	0	0xD4	0xD5
Device 1	0	1	0xD6	0xD7
Device 2	1	0	0xD8	0xD9
Device 3	1	1	0xDA	0xDB

### 9.5.2 I<sup>2</sup>C Bus Protocol

The device has a bidirectional serial-control interface that is compatible with the Inter IC (I<sup>2</sup>C) bus protocol and supports 100-kbps and 400-kbps data transfer rates for random and sequential write and read operations. The TAS6422-Q1 device is a slave-only device that does not support a multimaster bus environment or wait-state insertion. The control interface is used to program the registers of the device and to read device status.

The I<sup>2</sup>C bus uses two signals, SDA (data) and SCL (clock), to communicate between integrated circuits in a system. Data is transferred on the bus serially, one bit at a time. The address and data are transferred in byte (8-bit) format with the most-significant bit (MSB) transferred first. In addition, each byte transferred on the bus is acknowledged by the receiving device with an acknowledge bit. Each transfer operation begins with the master device driving a start condition on the bus and ends with the master device driving a stop condition on the bus. The bus uses transitions on the data terminal (SDA) while the clock is HIGH to indicate a start and stop conditions. A HIGH-to-LOW transition on SDA indicates a start, and a LOW-to-HIGH transition indicates a stop. Normal data bit transitions must occur within the low time of the clock period. The master generates the 7-bit slave address and the read/write (R/W) bit to open communication with another device and then wait for an acknowledge condition. The device holds SDA LOW during the acknowledge-clock period to indicate an acknowledgment. When this occurs, the master transmits the next byte of the sequence. Each device is addressed by a unique 7-bit slave address plus a R/W bit (1 byte). All compatible devices share the same signals via a bidirectional bus using a wired-AND connection. An external pullup resistor must be used for the SDA and SCL signals to set the HIGH level for the bus. The number of bytes that can be transmitted between start and stop conditions is unlimited. When the last word transfers, the master generates a stop condition to release the bus.

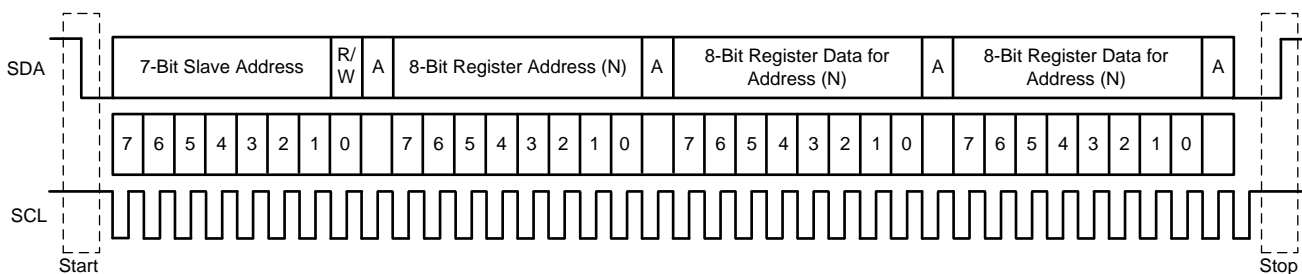

**Figure 41. Typical I<sup>2</sup>C Sequence**

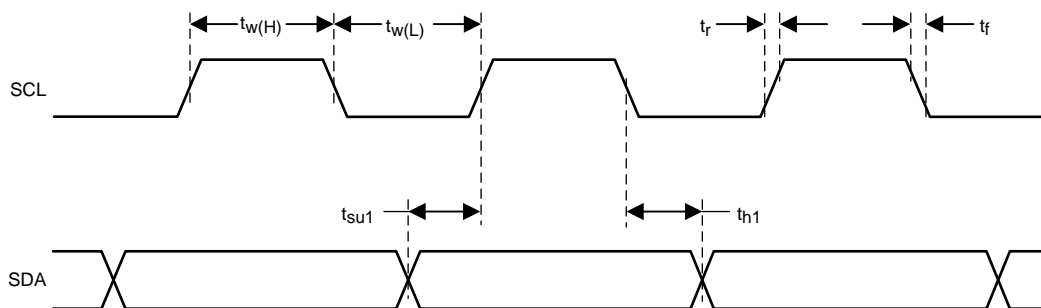

**Figure 42. SCL and SDA Timing**

Use the I<sup>2</sup>C ADDR<sub>x</sub> pins to program the device slave address. Read and write data can be transmitted using single-byte or multiple-byte data transfers.

### 9.5.3 Random Write

As shown in Figure 43, a single-byte data-write transfer begins with the master device transmitting a start condition followed by the I<sup>2</sup>C device address and the R/W bit. The R/W bit determines the direction of the data transfer. For a write data transfer, the R/W bit is a 0. After receiving the correct I<sup>2</sup>C device address and the R/W bit, the device responds with an acknowledge bit. Next, the master transmits the address byte or bytes corresponding to the internal memory address being accessed. After receiving the address byte, the device again responds with an acknowledge bit. Next, the master device transmits the data byte to be written to the memory address being accessed. After receiving the data byte, the device again responds with an acknowledge bit. Finally, the master device transmits a stop condition to complete the single-byte data-write transfer.

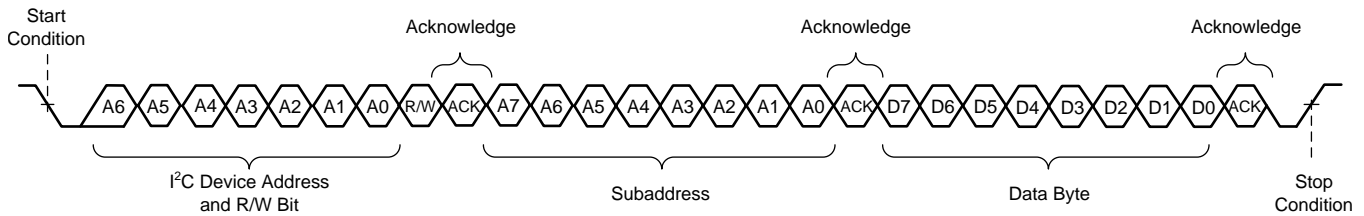

Figure 43. Random Write Transfer

### 9.5.4 Sequential Write

A sequential data-write transfer is identical to a single-byte data-write transfer except that multiple data bytes are transmitted by the master to the device as shown in Figure 44. After receiving each data byte, the device responds with an acknowledge bit and the I<sup>2</sup>C subaddress is automatically incremented by one.

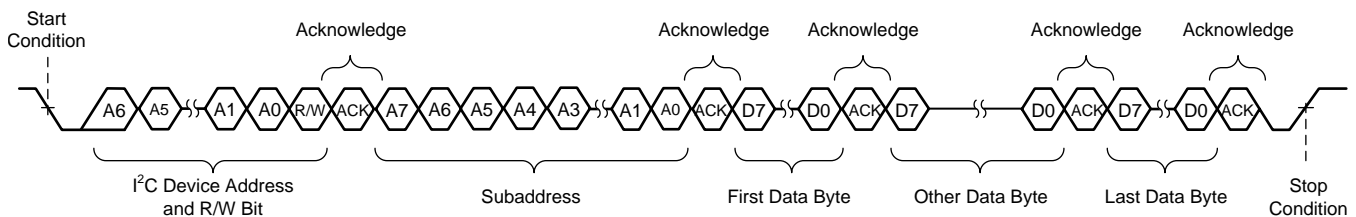

Figure 44. Sequential Write Transfer

### 9.5.5 Random Read

As shown in Figure 45, a single-byte data-read transfer begins with the master device transmitting a start condition followed by the I<sup>2</sup>C device address and the R/W bit. For the data-read transfer, both a write followed by a read occur. Initially, a write occurs to transfer the address byte or bytes of the internal memory address to be read. As a result, the R/W bit is a 0. After receiving the address and the R/W bit, the device responds with an acknowledge bit. In addition, after sending the internal memory address byte or bytes, the master device transmits another start condition followed by the address and the R/W bit again. This time the R/W bit is a 1, indicating a read transfer. After receiving the address and the R/W bit, the device again responds with an acknowledge bit. Next, the device transmits the data byte from the memory address being read. After receiving the data byte, the master device transmits a not-acknowledge followed by a stop condition to complete the single-byte data-read transfer.

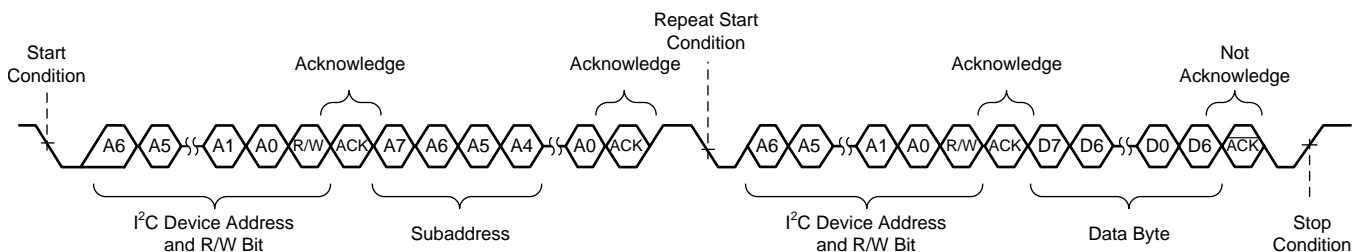

Figure 45. Random Read Transfer

### 9.5.6 Sequential Read

A sequential data-read transfer is identical to a single-byte data-read transfer except that multiple data bytes are transmitted by the device to the master device as shown in Figure 46. Except for the last data byte, the master device responds with an acknowledge bit after receiving each byte and automatically increments the I<sup>2</sup>C subaddress by one. After receiving the last data byte, the master device transmits a not-acknowledge bit followed by a stop condition to complete the transfer.

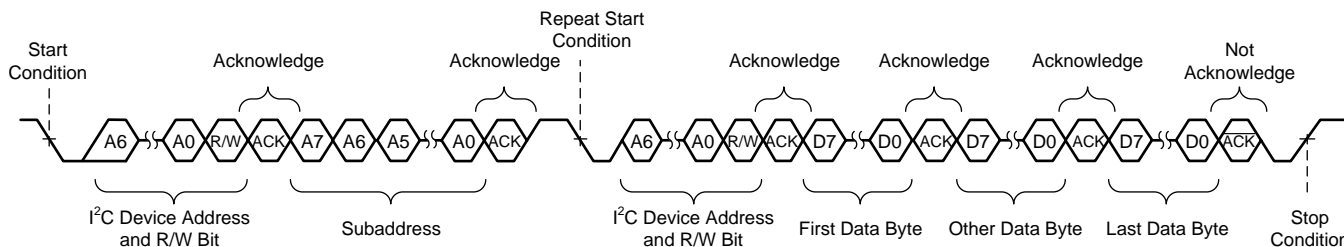

Figure 46. Sequential Read Transfer



## 9.6 Register Maps

**Table 9. I<sup>2</sup>C Address Register Definitions**

Address	Type	Register Description	Section
0x00	R/W	Mode control	<a href="#">Go</a>
0x01	R/W	Miscellaneous control 1	<a href="#">Go</a>
0x02	R/W	Miscellaneous control 2	<a href="#">Go</a>
0x03	R/W	SAP control (serial audio-port control)	<a href="#">Go</a>
0x04	R/W	Channel state control	<a href="#">Go</a>
0x05	R/W	Channel 1 volume control	<a href="#">Go</a>
0x06	R/W	Channel 2 volume control	<a href="#">Go</a>
0x07	R/W	RESERVED	<a href="#">Go</a>
0x08	R/W	RESERVED	<a href="#">Go</a>
0x09	R/W	DC diagnostic control 1	<a href="#">Go</a>
0x0A	R/W	DC diagnostic control 2	<a href="#">Go</a>
0x0B	R/W	RESERVED	
0x0C	R	DC load diagnostic report 1 (channels 1 and 2)	<a href="#">Go</a>
0x0D	R	RESERVED	
0x0E	R	DC load diagnostic report 3—line output	<a href="#">Go</a>
0x0F	R	Channel state reporting	<a href="#">Go</a>
0x10	R	Channel faults (overcurrent, DC detection)	<a href="#">Go</a>
0x11	R	Global faults 1	<a href="#">Go</a>
0x12	R	Global faults 2	<a href="#">Go</a>
0x13	R	Warnings	<a href="#">Go</a>
0x14	R/W	Pin control	<a href="#">Go</a>
0x15	R/W	AC load diagnostic control 1	<a href="#">Go</a>
0x16	R/W	AC load diagnostic control 2	<a href="#">Go</a>
0x17	R	AC load diagnostic report channel 1	<a href="#">Go</a>
0x18	R	AC load diagnostic report channel 2	<a href="#">Go</a>
0x19	R	RESERVED	<a href="#">Go</a>
0x1A	R	RESERVED	<a href="#">Go</a>
0x1B	R	AC load diagnostic phase report high	<a href="#">Go</a>
0x1C	R	AC load diagnostic phase report low	<a href="#">Go</a>
0x1D	R	AC load diagnostic STI report high	<a href="#">Go</a>
0x1E	R	AC load diagnostic STI report low	<a href="#">Go</a>
0x1F	R	RESERVED	
0x20	R	RESERVED	
0x21	R/W	Miscellaneous control 3	<a href="#">Go</a>
0x22	R/W	Clip control	<a href="#">Go</a>
0x23	R/W	Clip window	<a href="#">Go</a>
0x24	R/W	Clip warning	<a href="#">Go</a>
0x25	R/W	ILIMIT status	<a href="#">Go</a>
0x26	R/W	Miscellaneous control 4	<a href="#">Go</a>
0x27	R	RESERVED	
0x28	R/W	RESERVED	



### 9.6.1 Mode Control Register (address = 0x00) [default = 0x00]

The Mode Control register is shown in [Figure 47](#) and described in [Table 10](#).

**Figure 47. Mode Control Register**

7	6	5	4	3	2	1	0
RESET	RESERVED	RESERVED	PBTL CH12	CH1 LO MODE	CH2 LO MODE	RESERVED	RESERVED
R/W-0	R/W-0	R/W-0	R/W-0	R/W-0	R/W-0	R/W-0	R/W-0

**Table 10. Mode Control Field Descriptions**

Bit	Field	Type	Reset	Description
7	RESET	R/W	0	<b>0: Normal operation</b> 1: Resets the device
6	RESERVED	R/W	0	RESERVED
5	RESERVED	R/W	0	RESERVED
4	PBTL CH12	R/W	0	<b>0: Channels 1 and 2 are in BTL mode</b> 1: Channels 1 and 2 are in parallel BTL mode
3	CH1 LO MODE	R/W	0	<b>0: Channel 1 is in normal/speaker mode</b> 1: Channel 1 is in line output mode
2	CH2 LO MODE	R/W	0	<b>0: Channel 2 is in normal/speaker mode</b> 1: Channel 2 is in line output mode
1	RESERVED	R/W	0	RESERVED
0	RESERVED	R/W	0	RESERVED

### 9.6.2 Miscellaneous Control 1 Register (address = 0x01) [default = 0x32]

The Miscellaneous Control 1 register is shown in [Figure 48](#) and described in [Table 11](#).

**Figure 48. Miscellaneous Control 1 Register**

7	6	5	4	3	2	1	0
HPF BYPASS	OTW CONTROL		OC CONTROL	VOLUME RATE		GAIN	
R/W-0	R/W-01		R/W-1	R/W-00		R/W-10	

**Table 11. Misc Control 1 Field Descriptions**

Bit	Field	Type	Reset	Description
7	HPF BYPASS	R/W	0	<b>0: High pass filter enabled</b> 1: High pass filter disabled
6–5	OTW CONTROL	R/W	01	00: Global overtemperature warning set to 140°C <b>01: Global overtemperature warning set to 130C</b> 10: Global overtemperature warning set to 120°C 11: Global overtemperature warning set to 110°C
4	OC CONTROL	R/W	1	0: Overcurrent is level 1 <b>1: Overcurrent is level 2</b>
3–2	VOLUME RATE	R/W	00	<b>00: Volume update rate is 1 step / FSYNC</b> 01: Volume update rate is 1 step / 2 FSYNCs 10: Volume update rate is 1 step / 4 FSYNCs 11: Volume update rate is 1 step / 8 FSYNCs
1–0	GAIN	R/W	10	00: Gain level 1 = 7.6-V peak output voltage 01: Gain Level 2 = 15-V peak output voltage <b>10: Gain Level 3 = 21-V peak output voltage</b> 11: Gain Level 4 = 29-V peak output voltage

### 9.6.3 Miscellaneous Control 2 Register (address = 0x02) [default = 0x62]

The Miscellaneous Control 2 register is shown in Figure 49 and described in Table 12.

**Figure 49. Miscellaneous Control 2 Register**

7	6	5	4	3	2	1	0
RESERVED	PWM FREQUENCY			RESERVED	SDM_OSR	OUTPUT PHASE	
R/W-110				R/W-0		R/W-10	

**Table 12. Misc Control 2 Field Descriptions**

Bit	Field	Type	Reset	Description
7	RESERVED			<b>0</b>
6–4	PWM FREQUENCY	R/W	110	000: $8 \times f_S$ (352.8 kHz / 384 kHz) 001: $10 \times f_S$ (441 kHz / 480 kHz) 010: RESERVED 011: RESERVED 100: RESERVED 101: $38 \times f_S$ (1.68 MHz / 1.82 MHz) <b>110: <math>44 \times f_S</math> (1.94 MHz / 2.11 MHz)</b> 111: $48 \times f_S$ (2.12 MHz / not supported)
3	RESERVED		0	<b>0</b>
2	SDM_OSR	R/W	0	<b>0: 64x OSR</b> 1: 128x OSR
1–0	OUTPUT PHASE	R/W	10	00: 0 degrees output-phase switching offset 01: 30 degrees output-phase switching offset <b>10: 45 degrees output-phase switching offset</b> 11: 60 degrees output-phase switching offset

### 9.6.4 SAP Control (Serial Audio-Port Control) Register (address = 0x03) [default = 0x04]

The SAP Control (serial audio-port control) register is shown in Figure 50 and described in Table 13.

**Figure 50. SAP Control Register**

7	6	5	4	3	2	1	0
INPUT SAMPLING RATE		8 Ch TDM SLOT SELECT	TDM SLOT SIZE	TDM SLOT SELECT 2	INPUT FORMAT		
R/W-00		R/W-0	R/W-0	R/W-0	R/W-100		

**Table 13. SAP Control Field Descriptions**

Bit	Field	Type	Reset	Description
7–6	INPUT SAMPLING RATE	R/W	00	<b>00: 44.1 kHz</b> 01: 48 kHz 10: 96 kHz 11: RESERVED
5	8 Ch TDM SLOT SELECT	R/W	0	<b>0: First four TDM slots</b> 1: Last four TDM slots
4	TDM SLOT SIZE	R/W	0	<b>0: TDM slot size is 24-bit or 32-bit</b> 1: TDM slot size is 16-bit
3	TDM SLOT SELECT 2	R/W	0	<b>0: Normal</b> 1: swap channel 1/2 with channel 3/4

**Table 13. SAP Control Field Descriptions (continued)**

Bit	Field	Type	Reset	Description
2–0	INPUT FORMAT	R/W	100	000: 24-bit right justified 001: 20-bit right justified 010: 18-bit right justified 011: 16-bit right justified <b>100: I<sup>2</sup>S (16-bit or 24-bit)</b> 101: Left justified (16-bit or 24-bit) 110: DSP mode (16-bit or 24-bit) 111: RESERVED

### 9.6.5 Channel State Control Register (address = 0x04) [default = 0x55]

The Channel State Control register is shown in [Figure 51](#) and described in [Table 14](#).

**Figure 51. Channel State Control Register**

7	6	5	4	3	2	1	0
CH1 STATE CONTROL		CH2 STATE CONTROL		RESERVED		RESERVED	
R/W-01		R/W-01		R/W-01		R/W-01	

**Table 14. Channel State Control Field Descriptions**

Bit	Field	Type	Reset	Description
7–6	CH1 STATE CONTROL	R/W	01	00: PLAY <b>01: Hi-Z</b> 10: MUTE 11: DC load diagnostics
5–4	CH2 STATE CONTROL	R/W	01	00: PLAY <b>01: Hi-Z</b> 10: MUTE 11: DC load diagnostics
3–2	RESERVED	R/W	01	RESERVED
1–0	RESERVED	R/W	01	RESERVED

### 9.6.6 Channel 1 Through 2 Volume Control Registers (address = 0x05–0x06) [default = 0xCF]

The Channel 1 Through 2 Volume Control registers are shown in [Figure 52](#) and described in [Table 15](#).

**Figure 52. Channel x Volume Control Register**

7	6	5	4	3	2	1	0
CH x VOLUME							
R/W-CF							

**Table 15. Ch x Volume Control Field Descriptions**

Bit	Field	Type	Reset	Description
7–0	CH x VOLUME	R/W	CF	8-Bit Volume Control for each channel, register address for Ch1 is 0x05, Ch2 is 0x06, 0.5 dB/step: 0xFF: 24 dB <b>0xCF: 0 dB</b> 0x07: –100 dB < 0x07: MUTE

### 9.6.7 DC Load Diagnostic Control 1 Register (address = 0x09) [default = 0x00]

The DC Diagnostic Control 1 register is shown in [Figure 53](#) and described in [Table 16](#).

**Figure 53. DC Load Diagnostic Control 1 Register**

7	6	5	4	3	2	1	0
DC LDG ABORT	2x_RAMP	2x_SETTLE	RESERVED			LDG LO ENABLE	LDG BYPASS
R/W-0	R/W-0	R/W-0				R/W-0	R/W-0

**Table 16. DC Load Diagnostics Control 1 Field Descriptions**

Bit	Field	Type	Reset	Description
7	DC LDG ABORT	R/W	0	<b>0: Default state, clear after abort</b> 1: Aborts the load diagnostics in progress
6	2x_RAMP	R/W	0	<b>0: Normal ramp time</b> 1: Double ramp time
5	2x_SETTLE	R/W	0	<b>0: Normal Settle time</b> 1: Double settling time
4–2	RESERVED		0	<b>0</b>
1	LDG LO ENABLE	R/W	0	<b>0: Line output diagnostics are disabled</b> 1: Line output diagnostics are enabled
0	LDG BYPASS	R/W	0	<b>0: Automatic diagnostics when leaving Hi-Z and after channel fault</b> 1: Diagnostics are not run automatically

### 9.6.8 DC Load Diagnostic Control 2 Register (address = 0x0A) [default = 0x11]

The DC Diagnostic Control 2 register is shown in [Figure 54](#) and described in [Table 17](#).

**Figure 54. DC Load Diagnostic Control 2 Register**

7	6	5	4	3	2	1	0
CH1 DC LDG SL				CH2 DC LDG SL			
R/W-0001				R/W-0001			

**Table 17. DC Load Diagnostics Control 2 Field Descriptions**

Bit	Field	Type	Reset	Description
7–4	CH1 DC LDG SL	R/W	0001	DC load diagnostics shorted-load threshold 0000: 0.5 $\Omega$ <b>0001: 1 <math>\Omega</math></b> 0010: 1.5 $\Omega$ ... 1001: 5 $\Omega$
3–0	CH2 DC LDG SL	R/W	0001	DC load diagnostics shorted-load threshold 0000: 0.5 $\Omega$ <b>0001: 1 <math>\Omega</math></b> 0010: 1.5 $\Omega$ ... 1001: 5 $\Omega$

### 9.6.9 DC Load Diagnostic Report 1 Register (address = 0x0C) [default = 0x00]

DC Load Diagnostic Report 1 register is shown in [Figure 55](#) and described in [Table 18](#).

**Figure 55. DC Load Diagnostic Report 1 Register**

7	6	5	4	3	2	1	0
CH1 S2G	CH1 S2P	CH1 OL	CH1 SL	CH2 S2G	CH2 S2P	CH2 OL	CH2 SL
R-0	R-0	R-0	R-0	R-0	R-0	R-0	R-0

**Table 18. DC Load Diagnostics Report 1 Field Descriptions**

Bit	Field	Type	Reset	Description
7	CH1 S2G	R	0	<b>0: No short-to-GND detected</b> 1: Short-To-GND Detected
6	CH1 S2P	R	0	<b>0: No short-to-power detected</b> 1: Short-to-power detected
5	CH1 OL	R	0	<b>0: No open load detected</b> 1: Open load detected
4	CH1 SL	R	0	<b>0: No shorted load detected</b> 1: Shorted load detected
3	CH2 S2G	R	0	<b>0: No short-to-GND detected</b> 1: Short-to-GND detected
2	CH2 S2P	R	0	<b>0: No short-to-power detected</b> 1: Short-to-power detected
1	CH2 OL	R	0	<b>0: No open load detected</b> 1: Open load detected
0	CH2 SL	R	0	<b>0: No shorted load detected</b> 1: Shorted load detected

### 9.6.10 DC Load Diagnostics Report 3—Line Output—Register (address = 0x0E) [default = 0x00]

The DC Load Diagnostic Report, Line Output, register is shown in [Figure 56](#) and described in [Table 19](#).

**Figure 56. DC Load Diagnostics Report 3—Line Output—Register**

7	6	5	4	3	2	1	0
RESERVED				CH1 LO LDG	CH2 LO LDG	RESERVED	RESERVED
				R-0	R-0	R-0	R-0

**Table 19. DC Load Diagnostics Report 3—Line Output—Field Descriptions**

Bit	Field	Type	Reset	Description
7–4	RESERVED			<b>0</b>
3	CH1 LO LDG	R	0	<b>0: No line output detected on channel 1</b> 1: Line output detected on channel 1
2	CH2 LO LDG	R	0	<b>0: No line output detected on channel 2</b> 1: Line output detected on channel 2
1	RESERVED	R	0	RESERVED
0	RESERVED	R	0	RESERVED

### 9.6.11 Channel State Reporting Register (address = 0x0F) [default = 0x55]

The Channel State Reporting register is shown in [Figure 57](#) and described in [Table 20](#).

**Figure 57. Channel State-Reporting Register**

7	6	5	4	3	2	1	0
CH1 STATE REPORT		CH2 STATE REPORT		RESERVED		RESERVED	
R-01		R-01		R-01		R-01	

**Table 20. State-Reporting Field Descriptions**

Bit	Field	Type	Reset	Description
7–6	CH1 STATE REPORT	R	01	00: PLAY <b>01: Hi-Z</b> 10: MUTE 11: DC load diagnostics
5–4	CH2 STATE REPORT	R	01	00: PLAY <b>01: Hi-Z</b> 10: MUTE 11: DC load diagnostics
3–2	RESERVED	R	01	RESERVED
1–0	RESERVED	R	01	RESERVED

**9.6.12 Channel Faults (Overcurrent, DC Detection) Register (address = 0x10) [default = 0x00]**

The Channel Faults (overcurrent, DC detection) register is shown in [Figure 58](#) and described in [Table 21](#).

**Figure 58. Channel Faults Register**

7	6	5	4	3	2	1	0
CH1 OC	CH2 OC	RESERVED	RESERVED	CH1 DC	CH2 DC	RESERVED	RESERVED
R-0	R-0	R-0	R-0	R-0	R-0	R-0	R-0

**Table 21. Channel Faults Field Descriptions**

Bit	Field	Type	Reset	Description
7	CH1 OC	R	0	<b>0: No overcurrent fault detected</b> 1: Overcurrent fault detected
6	CH2 OC	R	0	<b>0: No overcurrent fault detected</b> 1: Overcurrent fault detected
5	RESERVED	R	0	RESERVED
4	RESERVED	R	0	RESERVED
3	CH1 DC	R	0	<b>0: No DC fault detected</b> 1: DC fault detected
2	CH2 DC	R	0	<b>0: No DC fault detected</b> 1: DC fault detected
1	RESERVED	R	0	RESERVED
0	RESERVED	R	0	RESERVED

**9.6.13 Global Faults 1 Register (address = 0x11) [default = 0x00]**

The Global Faults 1 register is shown in [Figure 59](#) and described in [Table 22](#).

**Figure 59. Global Faults 1 Register**

7	6	5	4	3	2	1	0
RESERVED			INVALID CLOCK	PVDD OV	VBAT OV	PVDD UV	VBAT UV
			R-0	R-0	R-0	R-0	R-0

**Table 22. Global Faults 1 Field Descriptions**

Bit	Field	Type	Reset	Description
7–5	RESERVED		0	<b>0</b>
4	INVALID CLOCK	R	0	<b>0: No clock fault detected</b> 1: Clock fault detected
3	PVDD OV	R	0	<b>0: No PVDD overvoltage fault detected</b> 1: PVDD overvoltage fault detected
2	VBAT OV	R	0	<b>0: No VBAT overvoltage fault detected</b> 1: VBAT overvoltage fault detected
1	PVDD UV	R	0	<b>0: No PVDD undervoltage fault detected</b> 1: PVDD undervoltage fault detected
0	VBAT UV	R	0	<b>0: No VBAT undervoltage fault detected</b> 1: VBAT undervoltage fault detected

#### 9.6.14 Global Faults 2 Register (address = 0x12) [default = 0x00]

The Global Faults 2 register is shown in [Figure 60](#) and described in [Table 23](#).

**Figure 60. Global Faults 2 Register**

7	6	5	4	3	2	1	0
RESERVED			OTSD	CH1 OTSD	CH2 OTSD	RESERVED	RESERVED
			R-0	R-0	R-0	R-0	R-0

**Table 23. Global Faults 2 Field Descriptions**

Bit	Field	Type	Reset	Description
7–5	RESERVED			<b>0</b>
4	OTSD	R	0	<b>0: No global overtemperature shutdown</b> 1: Global overtemperature shutdown
3	CH1 OTSD	R	0	<b>0: No overtemperature shutdown on Ch1</b> 1: Overtemperature shutdown on Ch1
2	CH2 OTSD	R	0	<b>0: No overtemperature shutdown on Ch2</b> 1: Overtemperature shutdown on Ch2
1	RESERVED	R	0	RESERVED
0	RESERVED	R	0	RESERVED

#### 9.6.15 Warnings Register (address = 0x13) [default = 0x20]

The Warnings register is shown in [Figure 61](#) and described in [Table 24](#).

**Figure 61. Warnings Register**

7	6	5	4	3	2	1	0
RESERVED		VDD POR	OTW	OTW CH1	OTW CH2	RESERVED	RESERVED
		R-0	R-0	R-0	R-0	R-0	R-0

**Table 24. Warnings Field Descriptions**

Bit	Field	Type	Reset	Description
7 -6	RESERVED		00	<b>0</b>
5	VDD POR	R	0	<b>0: No VDD POR has occurred</b> <b>1 VDD POR occurred</b>

**Table 24. Warnings Field Descriptions (continued)**

Bit	Field	Type	Reset	Description
4	OTW	R	0	<b>0: No global overtemperature warning</b> 1: Global overtemperature warning
3	OTW CH1	R	0	<b>0: No overtemperature warning on channel 1</b> 1: Overtemperature warning on channel 1
2	OTW CH2	R	0	<b>0: No overtemperature warning on channel 2</b> 1: Overtemperature warning on channel 2
1	RESERVED	R	0	RESERVED
0	RESERVED	R	0	RESERVED

**9.6.16 Pin Control Register (address = 0x14) [default = 0x00]**

 The Pin Control register is shown in [Figure 62](#) and described in [Table 25](#).

**Figure 62. Pin Control Register**

7	6	5	4	3	2	1	0
MASK OC	MASK OTSD	MASK UV	MASK OV	MASK DC	MASK ILIMIT	MASK CLIP	MASK OTW
R/W-1	R/W-1	R/W-1	R/W-1	R/W-1	R/W-1	R/W-1	R/W-1

**Table 25. Pin Control Field Descriptions**

Bit	Field	Type	Reset	Description
7	MASK OC	R/W	0	0: Report overcurrent faults on the $\overline{\text{FAULT}}$ pin 1: Do not report overcurrent faults on the $\overline{\text{FAULT}}$ Pin
6	MASK OTSD	R/W	0	0: Report overtemperature faults on the $\overline{\text{FAULT}}$ pin 1: Do not report overtemperature faults on the $\overline{\text{FAULT}}$ pin
5	MASK UV	R/W	0	0: Report undervoltage faults on the $\overline{\text{FAULT}}$ pin 1: Do not report undervoltage faults on the $\overline{\text{FAULT}}$ pin
4	MASK OV	R/W	0	0: Report overvoltage faults on the $\overline{\text{FAULT}}$ pin 1: Do not report overvoltage faults on the $\overline{\text{FAULT}}$ pin
3	MASK DC	R/W	0	0: Report DC faults on the $\overline{\text{FAULT}}$ pin 1: Do not report DC faults on the $\overline{\text{FAULT}}$ pin
2	MASK ILIMIT	R/W	0	0: Report Ilimit on the $\overline{\text{FAULT}}$ pin 1: Do not report Ilimit on the $\overline{\text{FAULT}}$ pin
1	MASK CLIP	R/W	0	0: Report clipping on the $\overline{\text{WARN}}$ pin 1: Do not report clipping on the $\overline{\text{WARN}}$ pin
0	MASK OTW	R/W	0	0: Report overtemperature warnings on the $\overline{\text{WARN}}$ pin 1: Do not report overtemperature warnings on the $\overline{\text{WARN}}$ pin

**9.6.17 AC Load Diagnostic Control 1 Register (address = 0x15) [default = 0x00]**

 The AC Load Diagnostic Control 1 register is shown in [Figure 63](#) and described in [Table 26](#).

**Figure 63. AC Load Diagnostic Control 1 Register**

7	6	5	4	3	2	1	0
CH1 GAIN	RESERVED	RESERVED	RESERVED	CH1 ENABLE	CH2 ENABLE	RESERVED	RESERVED
R/W-0	R/W-0	R/W-0	R/W-0	R/W-0	R/W-0	R/W-0	R/W-0



**Table 26. AC Load Diagnostic Control 1 Field Descriptions**

Bit	Field	Type	Reset	Description
7	CH1, CH2, PBTL12: GAIN	R/W	0	<b>0: Gain 1</b> 1: Gain 4
6	RESERVED	R/W	0	0
5	RESERVED	R/W	0	RESERVED
4	RESERVED	R/W	0	0
3	CH1 ENABLE	R/W	0	<b>0: AC diagnostics disabled</b> 1: Enable AC diagnostics
2	CH2 ENABLE	R/W	0	<b>0: AC diagnostics disabled</b> 1: Enable AC diagnostics
1	RESERVED	R/W	0	RESERVED
0	RESERVED	R/W	0	RESERVED

**9.6.18 AC Load Diagnostic Control 2 Register (address = 0x16) [default = 0x00]**

The AC Load Diagnostic Control 1 register is shown in [Figure 63](#) and described in [Table 26](#).

**Figure 64. AC Load Diagnostic Control 2 Register**

7	6	5	4	3	2	1	0
AC_DIAGS_LO OPBACK	RESERVED		AC TIMING	AC CURRENT		RESERVED	
R/W-0	R/W-0	R/W-0	R/W-0	R/W-0	R/W-0	R/W-0	R/W-0

**Table 27. AC Load Diagnostic Control 2 Field Descriptions**

Bit	Field	Type	Reset	Description
7	AC_DIAGS_LOOPBACK	R/W	0	<b>0: disable AC Diag loopback</b> 1: Enable AC Diag loopback
6-5	RESERVED	R/W	00	<b>00</b>
4	AC TIMING	R/W	0	<b>0: 32 Cycles</b> 1: 64 Cycles
3-2	AC CURRENT	R/W	00	<b>00: 10mA</b> 01: 19 mA 10: RESERVED 11: RESERVED
1-0	RESERVED	R/W	00	<b>00</b>

**9.6.19 AC Load Diagnostic Impedance Report Ch1 through CH2 Registers (address = 0x17–0x18) [default = 0x00]**

The AC Load Diagnostic Report Ch1 through CH2 registers are shown in [Figure 65](#) and described in [Table 28](#).

**Figure 65. AC Load Diagnostic Impedance Report Chx Register**

7	6	5	4	3	2	1	0
CHx IMPEDANCE							
R-00							

**Table 28. Chx AC LDG Impedance Report Field Descriptions**

Bit	Field	Type	Reset	Description
7–0	CH x IMPEDANCE	R	00	8-bit AC-load diagnostic report for each channel with a step size of 0.2496 $\Omega$ /bit (control by register 0x15 and register 0x16) <b>0x00: 0 <math>\Omega</math></b> 0x01: 0.2496 $\Omega$ ... 0xFF: 63.65 $\Omega$

**9.6.20 AC Load Diagnostic Phase Report High Register (address = 0x1B) [default = 0x00]**

 The AC Load Diagnostic Phase High value registers are shown in [Figure 66](#) and described in [Table 29](#).

**Figure 66. AC Load Diagnostic (LDG) Phase High Report Register**

7	6	5	4	3	2	1	0
AC Phase High							
R-00							

**Table 29. AC LDG Phase High Report Field Descriptions**

Bit	Field	Type	Reset	Description
7–0	AC Phase High	R	00	Bit 15:8

**9.6.21 AC Load Diagnostic Phase Report Low Register (address = 0x1C) [default = 0x00]**

 The AC Load Diagnostic Phase Low value registers are shown in [Figure 67](#) and described in [Table 30](#).

**Figure 67. AC Load Diagnostic (LDG) Phase Low Report Register**

7	6	5	4	3	2	1	0
AC Phase Low							
R-00							

**Table 30. AC LDG Phase Low Report Field Descriptions**

Bit	Field	Type	Reset	Description
7–0	AC Phase Low	R	00	Bit 7:0

**9.6.22 AC Load Diagnostic STI Report High Register (address = 0x1D) [default = 0x00]**

 The AC Load Diagnostic STI High value registers are shown in [Figure 68](#) and described in [Table 31](#).

**Figure 68. AC Load Diagnostic (LDG) STI High Report Register**

7	6	5	4	3	2	1	0
AC STI High							
R-00							

**Table 31. AC LDG STI High Report Field Descriptions**

Bit	Field	Type	Reset	Description
7–0	AC STI High	R	00	Bit 15:8

**9.6.23 AC Load Diagnostic STI Report Low Register (address = 0x1E) [default = 0x00]**

 The AC Load Diagnostic STI Low value registers are shown in [Figure 65](#) and described in [Table 32](#).

Figure 69. AC Load Diagnostic (LDG) STI Low Report Register

7	6	5	4	3	2	1	0
AC STI Low							
R-00							

Table 32. Chx AC LDG STI Low Report Field Descriptions

Bit	Field	Type	Reset	Description
7–0	AC STI Low	R	00	Bit 7:0

#### 9.6.24 Miscellaneous Control 3 Register (address = 0x21) [default = 0x00]

The Miscellaneous Control 3 register is shown in Figure 71 and described in Table 33.

Figure 70. Miscellaneous Control 3 Register

7	6	5	4	3	2	1	0
CLEAR FAULT	PBTL_CH_SEL	MASK ILIMIT WARNING	RESERVED	OTSD AUTO RECOVERY	RESERVED		
R/W-0	R/W-0	R/W-0	R/W-1	R/W-0			

Table 33. Misc Control 3 Field Descriptions

Bit	Field	Type	Reset	Description
7	CLEAR FAULT	R/W	0	<b>0: Normal operation</b> 1: Clear fault
6	PBTL_CH_SEL	R/W	0	<b>0: PBTL normal signal source</b> 1: PBTL flip signal source
5	MASK ILIMIT WARNING	R/W	0	<b>0: Report ILIMIT on the <math>\overline{\text{WARN}}</math> pin</b> 1: Do not report ILIMIT on the $\overline{\text{WARN}}$ pin
4	RESERVED	R/W	0	0
3	OTSD AUTO RECOVERY	R/W	0	<b>0: Latch overtemperature faults</b> 0: Automatic temperature protection recovery.
2–0	RESERVED		0	0

#### 9.6.25 Clip Control Register (address = 0x22) [default = 0x01]

The Clip Detect register is shown in Figure 71 and described in Table 34.

Figure 71. Clip Control Register

7	6	5	4	3	2	1	0
RESERVED							CLIPDET_EN
							R/W-1

Table 34. Clip Control Field Descriptions

Bit	Field	Type	Reset	Description
7-1	RESERVED			0
0	CLIPDET_EN	R/W	1	0: Clip detect disable <b>1: Clip Detect Enable</b>

#### 9.6.26 Clip Window Register (address = 0x23) [default = 0x14]

The Clip Window register is shown in Figure 72 and described in Table 35.

**Figure 72. Clip Window Register**

7	6	5	4	3	2	1	0
CLIP_WINDOW_SEL[7:1]							
R/W-0001110							

**Table 35. Clip Window Field Descriptions**

Bit	Field	Type	Reset	Description
7-0	CLIP_WINDOW_SEL[7:1]	R/W	00010100	00000000 00000001 00000010 00000011 00000100 00000101 00000110 00000111 00001000 00001001 00001010 00001110 00010100

**9.6.27 Clip Warning Register (address = 0x24) [default = 0x00]**

The Clip Window register is shown in [Figure 73](#) and described in [Table 36](#).

**Figure 73. Clip Warning Register**

7	6	5	4	3	2	1	0
RESERVED				RESERVED	RESERVED	CH2_CLIP	CH1_CLIP
				R-0	R-0	R-0	R-0

**Table 36. Clip Warning Field Descriptions**

Bit	Field	Type	Reset	Description
7-4	RESERVED		0	RESERVED
3	RESERVED	R	0	RESERVED
2	RESERVED	R	0	RESERVED
1	CH2_CLIP	R	0	<b>0: No Clip Detect</b> 1: Clip Detect
0	CH1_CLIP	R	0	<b>0: No Clip Detect</b> 1: Clip Detect

**9.6.28 ILIMIT Status Register (address = 0x25) [default = 0x00]**

The ILIMIT Status register is shown in [Figure 74](#) and described in [Table 37](#).

**Figure 74. ILIMIT Status Register**

7	6	5	4	3	2	1	0
RESERVED				RESERVED	RESERVED	CH2_ILIMIT_W ARN	CH1_ILIMIT_W ARN
				R-0	R-0	R-0	R-0

**Table 37. ILIMIT Status Field Descriptions**

Bit	Field	Type	Reset	Description
7	RESERVED		0	RESERVED
6	RESERVED		0	RESERVED
5	RESERVED		0	RESERVED
4	RESERVED		0	RESERVED
3	RESERVED	R	0	RESERVED
2	RESERVED	R	0	RESERVED
1	CH2_ILIMIT_WARN	R	0	<b>0: No ILIMIT</b> 1: ILIMIT Warning
0	CH1_ILIMIT_WARN	R	0	<b>0: No ILIMIT</b> 1: ILIMIT Warning

**9.6.29 Miscellaneous Control 4 Register (address = 0x26) [default = 0x40]**

The Miscellaneous Control 4 register is shown in [Figure 75](#) and described in [Table 38](#).

**Figure 75. Miscellaneous Control 4 Register**

7	6	5	4	3	2	1	0
RESERVED					HPF_CORNER[2:0]		
R/W-00000					R/W-000		

**Table 38. Misc Control 4 Field Descriptions**

Bit	Field	Type	Reset	Description
7-3	RESERVED	R/W	01000	<b>01000: DEFAULT</b>
2-0	HPF_CORNER[2:0]	R/W	000	<b>000: 3.7 Hz</b> 001: 7.4 Hz 010: 15 Hz 011: 30 Hz 100: 59 Hz 101: 118 Hz 110: 235 Hz 111: 463 Hz

## 10 Application and Implementation

### NOTE

Information in the following applications sections is not part of the TI component specification, and TI does not warrant its accuracy or completeness. TI's customers are responsible for determining suitability of components for their purposes. Customers should validate and test their design implementation to confirm system functionality.

### 10.1 Application Information

The TAS6422-Q1 is a two-channel class-D digital-input audio-amplifier design for use in automotive head units and external amplifier modules. The TAS6422-Q1 incorporates the necessary functionality to perform in demanding OEM applications.

#### 10.1.1 AM-Radio Band Avoidance

AM-radio frequency interference can be avoided by setting the switching frequency of the device above the AM band. The switching frequency options available are  $38 f_s$ ,  $44 f_s$ , and  $48 f_s$ . If the switch frequency cannot be set above the AM band, then use the two options of  $8 f_s$  and  $10 f_s$ . These options should be changed to avoid AM active channels.

#### 10.1.2 Parallel BTL Operation (PBTL)

The device can drive more current-parallel BTL channels on the load side of the LC output filter. For parallel operation, the parallel BTL mode, PBTL, must be used and the paralleled channels must have the same state in the state control register. If the two states are not aligned the device reports a fault condition.

To set the requested channels to PBTL mode the device must be in standby mode for the commands to take effect.

A load diagnostic is supported for PBTL channels. Paralleling on the device side of the LC output filter is not supported.

#### 10.1.3 Demodulation Filter Design

The amplifier outputs are driven by high-current LDMOS transistors in an H-bridge configuration. These transistors are either fully off or fully on. The result is a square-wave output signal with a duty cycle that is proportional to the amplitude of the audio signal. An LC demodulation filter is used to recover the audio signal. The filter attenuates the high-frequency components of the output signals that are out of the audio band. The design of the demodulation filter significantly affects the audio performance of the power amplifier. Therefore, to meet the system THD+N requirements, the selection of the inductors used in the output filter should be carefully considered.

#### 10.1.4 Line Driver Applications

In many automotive audio applications, the same head unit must drive either a speaker (with several ohms of impedance) or an external amplifier input (with several kilohms of impedance). The design is capable of supporting both applications and has special line-drive gain and diagnostics. Coupled with the high switching frequency, the device is well suited for this type of application. Set the desired channel in line driver mode through I<sup>2</sup>C register 0x00, the externally connected amplifier must have a differential impedance from 600  $\Omega$  to 4.7 k $\Omega$  for the DC line diagnostic to detect the connected external amplifier. [Figure 76](#) shows the recommended external amplifier input configuration.

Application Information (continued)

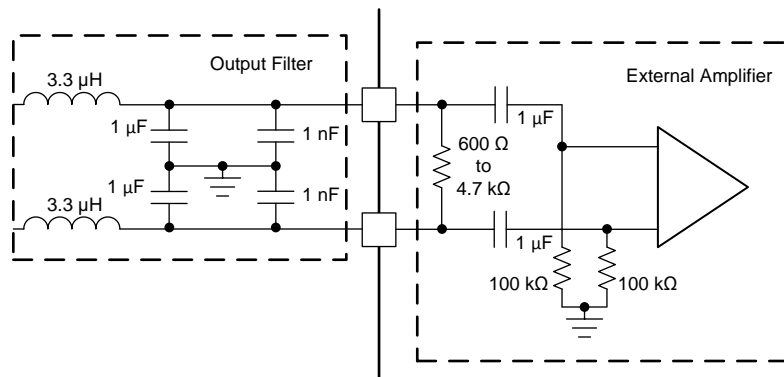

Figure 76. External Amplifier Input Configuration for Line Driver

10.2 Typical Application

10.2.1 BTL Application

Figure 77 shows the schematic of a typical 2-channel solution for a head-rest amplifier application.

Typical Application (continued)

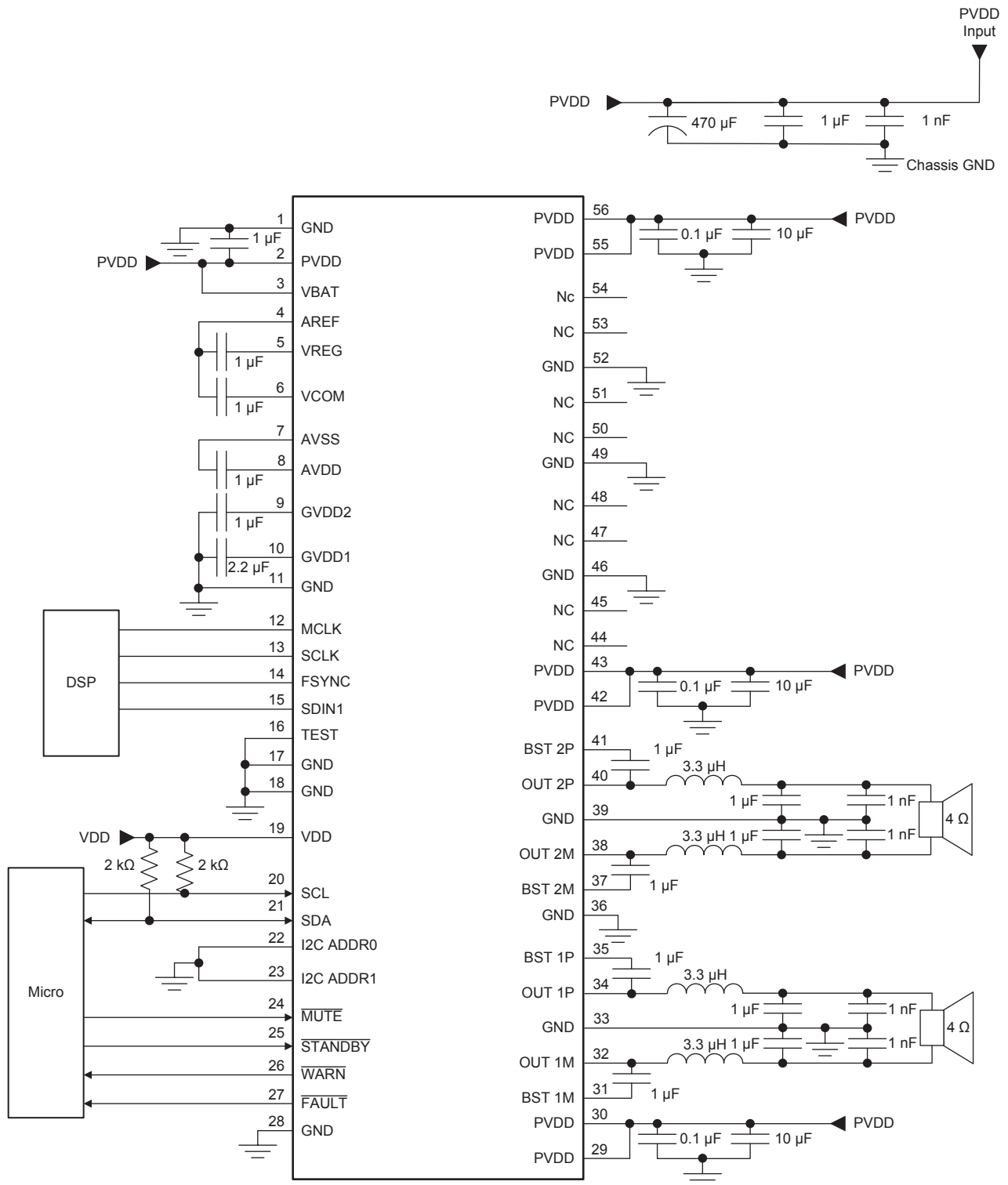

Figure 77. Typical 2-Channel BTL Application Schematic



## Typical Application (continued)

### 10.2.1.1 Design Requirements

Use the following requirements for this design:

- This headrest amplifier example is focused on the smallest solution size for  $2 \times 50\text{-W}$  output power into  $2 \Omega$  with a battery supply of 14.4 V.
- The switching frequency is set above the AM-band with 44 times the input sample rate of 48 kHz which results in a frequency of 2.11 MHz.
- The selection of a 2.11-MHz switch frequency enables the use of a small output inductor value of  $3.3 \mu\text{H}$  which leads to a very small solution size.

### 10.2.1.2 Communication

All communications to the TAS6422-Q1 are through the I<sup>2</sup>C protocol. A system controller can communicate with the device through the SDA pins and SCL pins. The TAS6422-Q1 is an I<sup>2</sup>C slave device and requires a master. The device cannot generate an I<sup>2</sup>C clock or initiate a transaction. The maximum clock speed accepted by the device is 400 kHz. If multiple TAS6422-Q1 devices are on the same I<sup>2</sup>C bus, the I<sup>2</sup>C address must be different for each device. Up to four TAS6422-Q1 devices can be on the same I<sup>2</sup>C bus.

The I<sup>2</sup>C bus is shared internally.

---

#### NOTE

Complete any internal operations, such as load diagnostics, before reading the registers for the results.

---

### 10.2.1.3 Detailed Design Procedure

#### 10.2.1.3.1 Hardware Design

Use the following procedure for the hardware design:

- Determine the input format. The input format can be either I<sup>2</sup>S or TDM mode. The mode determines the correct pin connections and the I<sup>2</sup>C register settings.
- Determine the power output that is required into the load. The power requirement determines the required power-supply voltage and current. The output reconstruction-filter components that are required are also driven by the output power.
- With the requirements, adjust the typical application schematic in [Figure 77](#) for the input connections.

## Typical Application (continued)

### 10.2.1.3.2 Digital Input and the Serial Audio Port

The TAS6422-Q1 device supports four different digital input formats which are: I<sup>2</sup>S, Right Justified, Left Justified, and TDM mode. Depending on the format, the device can support 16-, 18-, 20-, 24-, and 32-bit data. The supported frequencies are 96 kHz, 48 kHz, and 44.1 kHz. Please see [Table 13](#) for the I<sup>2</sup>C register, SAP Control, for the complete matrix to set up the serial audio port.

---

#### NOTE

Bits 3, 4, and 5 in this register are ignored in all input formats except for TDM. Setting up all the control registers to the system requirements should be done before the device is placed in Mute mode or Play mode. After the registers are setup, use bit 7 in register 0x21 to clear any faults. Then read the fault registers to make sure no faults are present. When no faults are present, use register 0x04 to place the device properly into play mode.

---

### 10.2.1.3.3 Bootstrap Capacitors

The bootstrap capacitors provide the gate-drive voltage of the upper N-channel FET. These capacitors must be sized appropriately for the system specification. A special condition can occur where the bootstrap may sag if the capacitor is not sized accordingly. The special condition is just below clipping where the PWM is slightly less than 100% duty cycle with sustained low-frequency signals. Changing the bootstrap capacitor value to 2.2  $\mu$ F for driving subwoofers that require frequencies below 30 Hz may be necessary.

### 10.2.1.3.4 Output Reconstruction Filter

The output FETs drive the amplifier outputs in an H-Bridge configuration. These transistors are either fully off or fully on. The result is a square-wave output signal with a duty cycle that is proportional to the amplitude of the audio signal. The amplifier outputs require a reconstruction filter that comprises a series inductor and a capacitor to ground on each output, generally called an LC filter. The LC filter attenuates the PWM frequency and reduces electromagnetic emissions, allowing the reconstructed audio signal to pass to the speakers. refer to the [Class-D LC Filter Design](#), (SLOA119) for a detailed description of proper component description and design of the LC filter based upon the specified load and frequency response. The recommended low-pass cutoff frequency of the LC filter is dependent on the selected switching frequency. The low-pass cutoff frequency can be as high as 100 kHz for a PWM frequency of 2.1 MHz. At a PWM frequency of 384 kHz the low-pass cutoff frequency should be less than 40 kHz. Certain specifications must be understood for a proper inductor. The inductance value is given at zero current, but the TAS6422-Q1 device will have current. Use the inductance versus current curve for the inductor to make sure the inductance does not drop below 2  $\mu$ H (for  $f_{SW} = 2.1$  MHz) at the maximum current provided by the system design. The DCR of the inductor directly affects the output power of the system design. The lower the DCR, the more power is provided to the speakers. The typical inductor DCR for a 4- $\Omega$  system is 40 to 50 m $\Omega$  and for a 2- $\Omega$  system is 20 to 25 m $\Omega$ .

## Typical Application (continued)

### 10.2.1.4 Application Curves

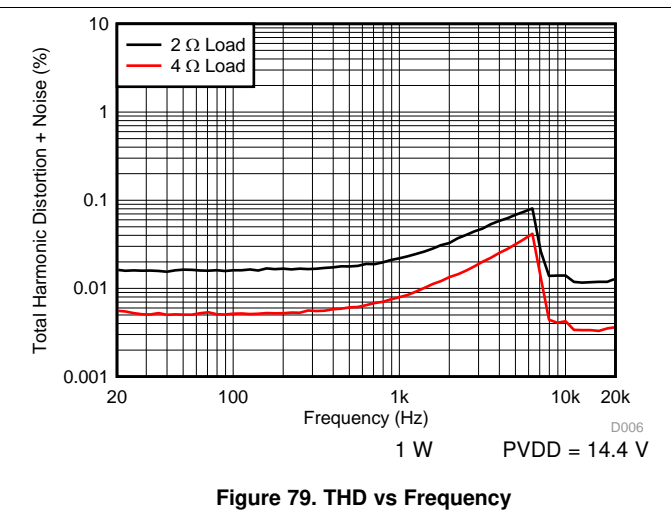
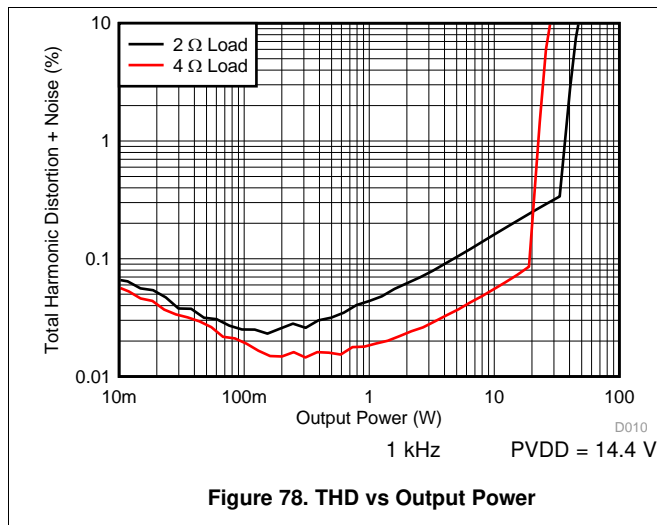

## 11 Power Supply Recommendations

The TAS6422-Q1 requires three power supplies. The PVDD supply is the high-current supply in the recommended supply range. The VBAT supply is lower current supply that must be in the recommended supply range. The PVDD and VBAT pins can be connected to the same supply if the recommended supply range for VBAT is maintained. The VDD supply is the 3.3-Vdc logic supply and must be maintained in the tolerance as shown in the [Recommended Operating Conditions](#) table.

## 12 Layout

### 12.1 Layout Guidelines

The pinout of the TAS6422-Q1 was selected to provide flowthrough layout with all high-power connections on the right side, and all low-power signals and supply decoupling on the left side.

[Figure 80](#) shows the area for the components in the application example (see the [Typical Application](#) section).

The TAS6422-Q1 EVM uses a four-layer PCB. The copper thickness was selected as 70  $\mu\text{m}$  to optimize power loss.

The small value of the output filter provides a small size and, in this case, the low height of the inductor enables double-sided mounting.

The EVM PCB shown in [Figure 80](#) is the basis for the layout guidelines.

The TAS6422-Q1 is pinout compatible with the TAS6424-Q1. It will fit the TAS6424-Q1 layout if the output filter and bootstrap components for TAS6424-Q1 channels 3 and 4 are not stuffed, this gives the option to use a single PCB layout with stuffing options for different end equipments

#### 12.1.1 Electrical Connection of Thermal pad and Heat Sink

For the DKQ package, the heat sink connected to the thermal pad of the device should be connected to GND. The heat slug must not be connected to any other electrical node.

## Layout Guidelines (continued)

### 12.1.2 EMI Considerations

Automotive-level EMI performance depends on both careful integrated circuit design and good system-level design. Controlling sources of electromagnetic interference (EMI) was a major consideration in all aspects of the design. The design has minimal parasitic inductances because of the short leads on the package which reduces the EMI that results from current passing from the die to the system PCB. Each channel also operates at a different phase. The design also incorporates circuitry that optimizes output transitions that cause EMI.

For optimizing the EMI a solid ground layer plane is recommended, for a PCB design the fulfills the CISPR25 level 5 requirements, see the TAS6422-Q1 EVM layout.

### 12.1.3 General Guidelines

The EVM layout is optimized for low noise and EMC performance.

The TAS6422-Q1 has an exposed thermal pad that is up, away from the PCB. The layout must consider an external heat sink.

Refer to [Figure 80](#) for the following guidelines:

- A ground plane, *A*, on the same side as the device pins helps reduce EMI by providing a very-low loop impedance for the high-frequency switching current.
- The decoupling capacitors on PVDD, *B*, are very close to the device with the ground return close to the ground pins.
- The ground connections for the capacitors in the LC filter, *C*, have a direct path back to the device and also the ground return for each channel is the shared. This direct path allows for improved common mode EMI rejection.
- The traces from the output pins to the inductors, *D*, should have the shortest trace possible to allow for the smallest loop of large switching currents.
- Heat-sink mounting screws, *E*, should be close to the device to keep the loop short from the package to ground.
- Many vias, *F*, stitching together the ground planes can create a shield to isolate the amplifier and power supply.

## 12.2 Layout Example

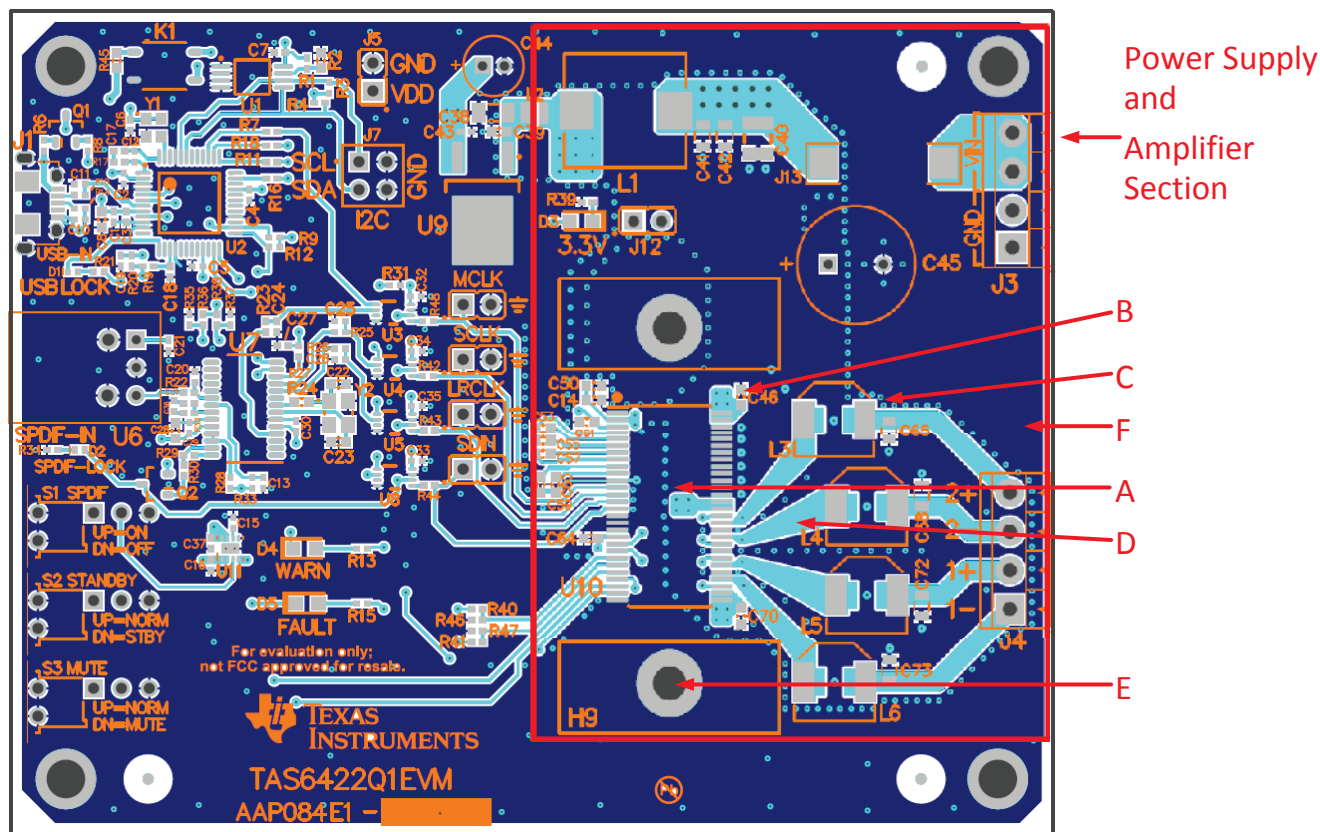

Figure 80. EVM Layout

## 12.3 Thermal Considerations

The thermally enhanced PowerPAD package has an exposed pad up for connection to a heat sink. The output power of any amplifier is determined by the thermal performance of the amplifier as well as limitations placed on it by the system, such as the ambient operating temperature. The heat sink absorbs heat from the TAS6422-Q1 and transfers it to the air. With proper thermal management this process can reach equilibrium and heat can be continually transferred from the device. Heat sinks can be smaller than that of classic linear amplifier design because of the excellent efficiency of class-D amplifiers. This device is intended for use with a heat sink, therefore,  $R_{\theta JC}$  will be used as the thermal resistance from junction to the exposed metal package. This resistance will dominate the thermal management, so other thermal transfers will not be considered. The thermal resistance of  $R_{\theta JA}$  (junction to ambient) is required to determine the full thermal solution. The thermal resistance is comprised of the following components:

- $R_{\theta JC}$  of the TAS6422-Q1
- Thermal resistance of the thermal interface material
- Thermal resistance of the heat sink

The thermal resistance of the thermal interface material can be determined from the manufacturer's value for the area thermal resistance (expressed in  $^{\circ}\text{C}\text{-mm}^2/\text{W}$ ) and the area of the exposed metal package. For example, a typical, white, thermal grease with a 0.0254-mm (0.001-inch) thick layer is approximately  $4.52^{\circ}\text{C}\text{-mm}^2/\text{W}$ . The TAS6422-Q1 in the DKQ package has an exposed area of  $47.6\text{ mm}^2$ . By dividing the area thermal resistance by the exposed metal area determines the thermal resistance for the thermal grease. The thermal resistance of the thermal grease is  $0.094^{\circ}\text{C}/\text{W}$

lists the modeling parameters for one device on a heat sink. The junction temperature is assumed to be  $115^{\circ}\text{C}$  while delivering an average power of 10 watts per channel into a  $4\text{-}\Omega$  load. The thermal-grease example previously described is used for the thermal interface material. Use Equation 1 to design the thermal system.

## Thermal Considerations (continued)

$$R_{\theta JA} = R_{\theta JC} + \text{thermal interface resistance} + \text{heat sink resistance} \tag{1}$$

**Table 39. Thermal Modeling**

Description	Value
Ambient Temperature	25°C
Average Power to load	20W (2x 10w)
Power dissipation	4W (2x 2w)
Junction Temperature	115°C
ΔT inside package	5.6°C (1.4°C/W × 4W)
ΔT through thermal interface material	0.38°C (0.094°C/W × 4W)
Required heat sink thermal resistance	21°C/W ([115°C – 25°C – 5.6°C – 0.38°C] / 4W)
System thermal resistance to ambient $R_{\theta JA}$	21.4°C/W

## 13 Device and Documentation Support

### 13.1 Documentation Support

#### 13.1.1 Related Documentation

For related documentation see the following:

- [PurePath™ Console 3 User Manual](#) (SLOU408)
- [TAS6424-Q1 EVM User's Guide](#) (SLOU453)

### 13.2 Receiving Notification of Documentation Updates

To receive notification of documentation updates, navigate to the device product folder on ti.com. In the upper right corner, click on *Alert me* to register and receive a weekly digest of any product information that has changed. For change details, review the revision history included in any revised document.

### 13.3 Community Resources

The following links connect to TI community resources. Linked contents are provided "AS IS" by the respective contributors. They do not constitute TI specifications and do not necessarily reflect TI's views; see TI's [Terms of Use](#).

**TI E2E™ Online Community** *TI's Engineer-to-Engineer (E2E) Community*. Created to foster collaboration among engineers. At e2e.ti.com, you can ask questions, share knowledge, explore ideas and help solve problems with fellow engineers.

**E2E Audio Amplifier Forum** *TI's Engineer-to-Engineer (E2E) Community for Audio Amplifiers*. Created to foster collaboration among engineers. Ask questions and receive answers in real-time.

### 13.4 Trademarks

PowerPAD, PurePath, E2E are trademarks of Texas Instruments. All other trademarks are the property of their respective owners.

### 13.5 Electrostatic Discharge Caution



These devices have limited built-in ESD protection. The leads should be shorted together or the device placed in conductive foam during storage or handling to prevent electrostatic damage to the MOS gates.

### 13.6 Glossary

[SLYZ022](#) — *TI Glossary*.

This glossary lists and explains terms, acronyms, and definitions.

## 14 Mechanical, Packaging, and Orderable Information

The following pages include mechanical, packaging, and orderable information. This information is the most current data available for the designated devices. This data is subject to change without notice and revision of this document. For browser-based versions of this data sheet, refer to the left-hand navigation.

**PACKAGING INFORMATION**

Orderable Device	Status (1)	Package Type	Package Drawing	Pins	Package Qty	Eco Plan (2)	Lead finish/ Ball material (6)	MSL Peak Temp (3)	Op Temp (°C)	Device Marking (4/5)	Samples
TAS6422QDKQRQ1	ACTIVE	HSSOP	DKQ	56	1000	RoHS & Green	NIPDAU	Level-3-260C-168 HR	-40 to 125	TAS6422	Samples

(1) The marketing status values are defined as follows:

**ACTIVE:** Product device recommended for new designs.

**LIFEBUY:** TI has announced that the device will be discontinued, and a lifetime-buy period is in effect.

**NRND:** Not recommended for new designs. Device is in production to support existing customers, but TI does not recommend using this part in a new design.

**PREVIEW:** Device has been announced but is not in production. Samples may or may not be available.

**OBSOLETE:** TI has discontinued the production of the device.

(2) **RoHS:** TI defines "RoHS" to mean semiconductor products that are compliant with the current EU RoHS requirements for all 10 RoHS substances, including the requirement that RoHS substance do not exceed 0.1% by weight in homogeneous materials. Where designed to be soldered at high temperatures, "RoHS" products are suitable for use in specified lead-free processes. TI may reference these types of products as "Pb-Free".

**RoHS Exempt:** TI defines "RoHS Exempt" to mean products that contain lead but are compliant with EU RoHS pursuant to a specific EU RoHS exemption.

**Green:** TI defines "Green" to mean the content of Chlorine (Cl) and Bromine (Br) based flame retardants meet JS709B low halogen requirements of <=1000ppm threshold. Antimony trioxide based flame retardants must also meet the <=1000ppm threshold requirement.

(3) MSL, Peak Temp. - The Moisture Sensitivity Level rating according to the JEDEC industry standard classifications, and peak solder temperature.

(4) There may be additional marking, which relates to the logo, the lot trace code information, or the environmental category on the device.

(5) Multiple Device Markings will be inside parentheses. Only one Device Marking contained in parentheses and separated by a "-" will appear on a device. If a line is indented then it is a continuation of the previous line and the two combined represent the entire Device Marking for that device.

(6) Lead finish/Ball material - Orderable Devices may have multiple material finish options. Finish options are separated by a vertical ruled line. Lead finish/Ball material values may wrap to two lines if the finish value exceeds the maximum column width.

**Important Information and Disclaimer:** The information provided on this page represents TI's knowledge and belief as of the date that it is provided. TI bases its knowledge and belief on information provided by third parties, and makes no representation or warranty as to the accuracy of such information. Efforts are underway to better integrate information from third parties. TI has taken and continues to take reasonable steps to provide representative and accurate information but may not have conducted destructive testing or chemical analysis on incoming materials and chemicals. TI and TI suppliers consider certain information to be proprietary, and thus CAS numbers and other limited information may not be available for release.

In no event shall TI's liability arising out of such information exceed the total purchase price of the TI part(s) at issue in this document sold by TI to Customer on an annual basis.



## TAPE AND REEL INFORMATION



### QUADRANT ASSIGNMENTS FOR PIN 1 ORIENTATION IN TAPE



\*All dimensions are nominal

Device	Package Type	Package Drawing	Pins	SPQ	Reel Diameter (mm)	Reel Width W1 (mm)	A0 (mm)	B0 (mm)	K0 (mm)	P1 (mm)	W (mm)	Pin1 Quadrant
TAS6422QDKQRQ1	HSSOP	DKQ	56	1000	330.0	32.4	11.35	18.67	3.1	16.0	32.0	Q1

TAPE AND REEL BOX DIMENSIONS



\*All dimensions are nominal

Device	Package Type	Package Drawing	Pins	SPQ	Length (mm)	Width (mm)	Height (mm)
TAS6422QDKQRQ1	HSSOP	DKQ	56	1000	367.0	367.0	55.0

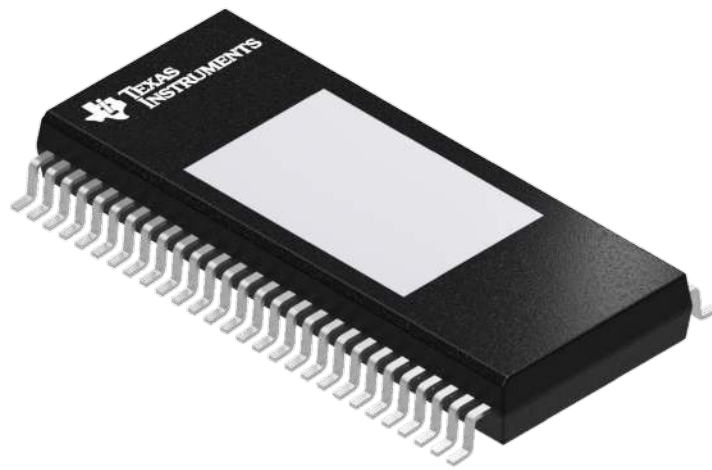

Images above are just a representation of the package family, actual package may vary.  
Refer to the product data sheet for package details.

## IMPORTANT NOTICE AND DISCLAIMER

TI PROVIDES TECHNICAL AND RELIABILITY DATA (INCLUDING DATA SHEETS), DESIGN RESOURCES (INCLUDING REFERENCE DESIGNS), APPLICATION OR OTHER DESIGN ADVICE, WEB TOOLS, SAFETY INFORMATION, AND OTHER RESOURCES "AS IS" AND WITH ALL FAULTS, AND DISCLAIMS ALL WARRANTIES, EXPRESS AND IMPLIED, INCLUDING WITHOUT LIMITATION ANY IMPLIED WARRANTIES OF MERCHANTABILITY, FITNESS FOR A PARTICULAR PURPOSE OR NON-INFRINGEMENT OF THIRD PARTY INTELLECTUAL PROPERTY RIGHTS.

These resources are intended for skilled developers designing with TI products. You are solely responsible for (1) selecting the appropriate TI products for your application, (2) designing, validating and testing your application, and (3) ensuring your application meets applicable standards, and any other safety, security, regulatory or other requirements.

These resources are subject to change without notice. TI grants you permission to use these resources only for development of an application that uses the TI products described in the resource. Other reproduction and display of these resources is prohibited. No license is granted to any other TI intellectual property right or to any third party intellectual property right. TI disclaims responsibility for, and you will fully indemnify TI and its representatives against, any claims, damages, costs, losses, and liabilities arising out of your use of these resources.

TI's products are provided subject to [TI's Terms of Sale](#) or other applicable terms available either on [ti.com](https://www.ti.com) or provided in conjunction with such TI products. TI's provision of these resources does not expand or otherwise alter TI's applicable warranties or warranty disclaimers for TI products.

TI objects to and rejects any additional or different terms you may have proposed.

Mailing Address: Texas Instruments, Post Office Box 655303, Dallas, Texas 75265  
Copyright © 2023, Texas Instruments Incorporated