

## 800 mA ultra low drop, high PSRR voltage regulator

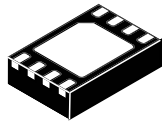

DFN8 2x3 mm

### Features

- Input voltage from 1 to 5.5 V
- Ultra low-dropout voltage (90 mV max. @ 800 mA load)
- Low ground current (35  $\mu$ A typ. @ no load)
- Output voltage tolerance:  $\pm 2.0\%$  @ 25 °C
- High PSRR: 80 dB @ 100 Hz, 50 dB @ 1 MHz
- 800 mA guaranteed output current
- Wide range of output voltages available on request: from 0.5 V to 4 V and adjustable
- Logic-controlled electronic shutdown
- Internal current and thermal limit
- Power Good function
- Available in DFN8 2x3 mm package
- Temperature range: -40 °C to 125 °C
- Input voltage control for the ST1L08Sxx

### Applications

- Consumer
- Hard disk drives, SSD
- Computer
- Battery-powered systems
- Low voltage point of load

Maturity status link

ST1L08

### Description

The **ST1L08** provides 0.8 A of maximum current from an input voltage in the range from 1 V to 5.5 V, with a typical dropout voltage as low as 70 mV.

It is stabilized with a ceramic capacitor on the output.

The very low drop voltage, low quiescent current and high PSRR features make it suitable for low power battery-powered applications.

Enable logic control function puts the **ST1L08** in shutdown mode, reducing the total current consumption.

Power Good function and input voltage control feature the ST1L08Sxx version.

The device is equipped with current limit and thermal protection.

# 1 Diagram

Figure 1. Block diagram

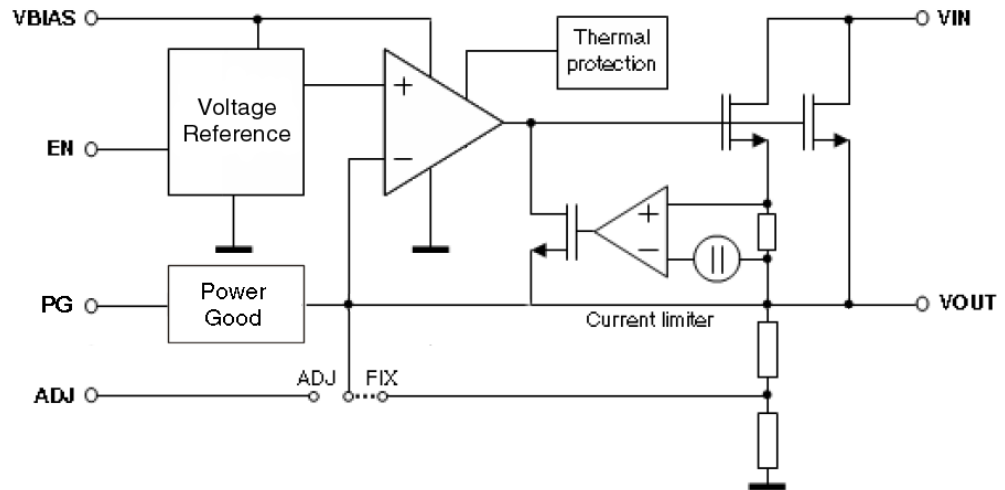

GIPD151020151423MT

## 2 Pin configuration

Figure 2. Pin connection (top view)



GIPD151020151427MT

Table 1. Pin description

Symbol	Function
$V_{IN}$	Input voltage of the LDO (power element)
$V_{BIAS}$	Bias input of the LDO
GND	Common ground
EN	Enable pin logic input: low = shutdown, high = active
ADJ	Adjustable pin (on adjustable version)
$V_{OUT}$	Output voltage of the LDO
PG	Power Good pin (not connected on the ST1L08PUR)
NC	Not connected
EXP	Exposed pad (should be connected to GND)

### 3 Typical application

**Figure 3. Typical application circuits**

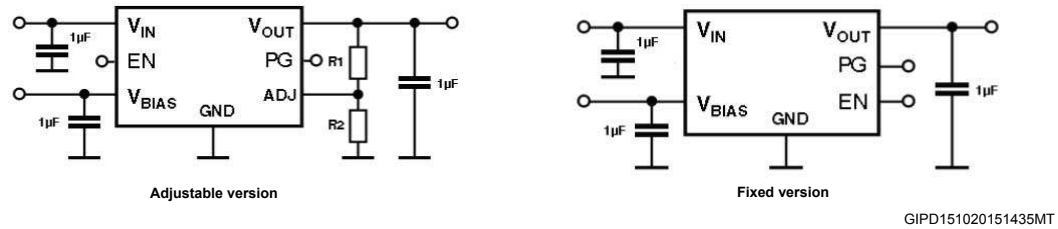

*Note:* Power Good feature is not present on the ST1L08PUR.

## 4 Maximum ratings

**Table 2. Absolute maximum ratings**

Symbol	Parameter	Value	Unit
$V_{IN}$	DC input voltage	- 0.3 to 7	V
$V_{BIAS}$	DC bias voltage	- 0.3 to 7	V
$V_{OUT}$	DC output voltage	- 0.3 to $V_I + 0.3$	V
$V_{EN}$	Enable input voltage	- 0.3 to $V_{BIAS} + 0.3$	V
$V_{PG}$	Power Good pin voltage	- 0.3 to $V_{BIAS} + 0.3$	V
$V_{ADJ}$	ADJ pin voltage	- 0.3 to $V_{BIAS} + 0.3$	V
$I_{OUT}$	Output current	Internally limited	mA
$P_D$	Power dissipation	Internally limited	mW
$T_{STG}$	Storage temperature range	- 65 to 150	°C
$T_{OP}$	Operating junction temperature range	- 40 to 125	°C

*Note:* Absolute maximum ratings are those values beyond which damage to the device may occur. Functional operation under these conditions is not implied. All values are referred to GND.

**Table 3. Thermal data**

Symbol	Parameter	DFN8 (2x3 mm)	Unit
$R_{thJA}$	Thermal resistance junction-ambient	55	°C/W
$R_{thJC}$	Thermal resistance junction-case	12	°C/W

## 5 Electrical characteristics

$T_J = 25\text{ °C}$ ,  $V_{IN} = 1.5\text{ V}$ ,  $V_{BIAS} = 3.6\text{ V}$ ,  $V_{OUT} = V_{ADJ}$ ,  $C_{IN} = C_{BIAS} = 1\text{ }\mu\text{F}$ ,  $C_{OUT} = 4.7\text{ }\mu\text{F}$ ,  $V_{EN} = V_{BIAS}$ , unless otherwise specified.

**Table 4. Electrical characteristics for the ST1L08 (adjustable)**

Symbol	Parameter	Test conditions	Min.	Typ.	Max.	Unit
$V_{IN}$	Operating input voltage		1		5.5	V
$V_{BIAS}$	Operating bias voltage <sup>(1)</sup>		2.7		5.5	V
$I_{IN}$	$V_{IN}$ operating current			0.2	10	$\mu\text{A}$
$I_{BIAS}$	$V_{BIAS}$ operating current	$I_{OUT} = 10\text{ }\mu\text{A}$		40	150	$\mu\text{A}$
$V_{ADJ}$	$V_{ADJ}$ accuracy	$I_{OUT} = 1\text{ mA to }800\text{ mA } T_J = 25\text{ °C}$	0.490	0.500	0.510	V
		$-40\text{ °C} < T_J < 125\text{ °C } V_{OUT} = 0.5\text{ V}$	0.487	0.500	0.512	
$\Delta V_{OUT}$	$V_{IN}$ static line regulation	$I_{OUT} = 1\text{ mA } V_{OUT} = 0.5\text{ V}$ $V_{BIAS} = 3.6\text{ V}, 1\text{ V} \leq V_{IN} \leq 5.5\text{ V}$		0.002	0.01	%/V
	$V_{BIAS}$ static line regulation	$I_{OUT} = 100\text{ mA } V_{OUT} = 0.5\text{ V}$ $V_{IN} = 1.5\text{ V } 2.7\text{ V} \leq V_{BIAS} \leq 5.5\text{ V}$		0.04	0.2	%/V
$\Delta V_{OUT}$	Static load regulation	$I_{OUT} = 1\text{ mA to }800\text{ mA}$		0.0002	0.001	%/mA
$V_{DROP}$	Dropout voltage	$I_{OUT} = 800\text{ mA } V_{BIAS} = 3.6\text{ V}$		70	90	mV
		$40\text{ °C} < T_J < 125\text{ °C}$			120	
$e_N$	Output noise voltage	10 Hz to 100 kHz $I_{OUT} = 10\text{ mA}$		50		$\mu\text{VRMS}$
SVR	Supply voltage rejection	$V_{IN} > V_{OUT} + 0.5\text{ V } +/- V_{RIPPLE}$ $V_{RIPPLE} = 0.1\text{ V } f = 100\text{ Hz}$		80		dB
		$f = 10\text{ kHz}$		60		
		$f = 1\text{ MHz}$		50		
$I_{GND}$	Ground current	$I_{OUT} = 0\text{ mA } T_J = 25\text{ °C}$		35		$\mu\text{A}$
		$I_{OUT} = 500\text{ mA } T_J = 25\text{ °C}$		40		
		$I_{OUT} = 800\text{ mA } 40\text{ °C} < T_J < 125\text{ °C}$		40	150	
$I_{SC}$	Short-circuit current	$R_L = 0$		1.8		A
$V_{EN}$	Enable input logic low				0.8	
	Enable input logic high		1.3			V
$I_{EN}$	Enable pin input current	$V_{EN} = 1.3\text{ V}$			1	$\mu\text{A}$
PG <sup>(2)</sup>	Power Good output threshold	Rising edge		$0.92 \cdot V_{OUT}$		V
		Falling edge		$0.8 \cdot V_{OUT}$		
	Power Good output voltage low	$I_{sink} = 6\text{ mA open drain output}$				0.4
$T_{SHDN}$	Thermal shutdown			165		$^{\circ}\text{C}$
	Hysteresis			20		

1. Important: in any case  $V_{BIAS} \geq V_{OUT} + 1.5\text{ V}$ .
2. Power Good feature is not available on the ST1L08PUR.

$T_J = 25\text{ }^\circ\text{C}$ ,  $V_{IN} = V_{OUT} + 0.5\text{ V}$ ,  $V_{BIAS} = V_{OUT} + 1.5\text{ V}$  (Important: in any case  $V_{BIAS} \geq V_{OUT} + 1.5\text{ V}$ ),  $C_{IN} = C_{BIAS} = 1\text{ }\mu\text{F}$ ,  $C_{OUT} = 4.7\text{ }\mu\text{F}$ ,  $V_{EN} = V_{BIAS}$ , unless otherwise specified.

Symbol	Parameter	Test conditions	Min.	Typ.	Max.	Unit
$V_{IN}$	Operating input voltage		1		5.5	V
$V_{BIAS}$	Operating bias voltage <sup>(1)</sup>		2.7		5.5	V
$V_{OUT}$	Output voltage range		0.5		4	V
$I_{IN}$	$V_{IN}$ operating current			4	10	$\mu\text{A}$
$I_{BIAS}$	$V_{BIAS}$ operating current	$I_{OUT} = 10\text{ }\mu\text{A}$		45	150	$\mu\text{A}$
$V_{OUT}$	$V_{OUT}$ accuracy	$I_{OUT} = 1\text{ mA to }800\text{ mA } T_J = 25\text{ }^\circ\text{C}$	-2		2	
		$-40\text{ }^\circ\text{C} < T_J < 125\text{ }^\circ\text{C}$	-2.5		2.5	%
$\Delta V_{OUT}$	$V_{IN}$ static line regulation	$I_{OUT} = 1\text{ mA } V_{BIAS} = V_{OUT} + 1.5\text{ V}$ $V_{OUT} + 0.5\text{ V} \leq V_{IN} \leq 5.5\text{ V}$		0.003	0.015	%/V
	$V_{BIAS}$ static line regulation	$I_{OUT} = 100\text{ mA } V_{IN} = V_{OUT} + 0.5\text{ V}$ $V_{OUT} + 1.5\text{ V} \leq V_{BIAS} \leq 5.5\text{ V}$		0.04	0.2	%/V
$\Delta V_{OUT}$	Static load regulation	$I_{OUT} = 1\text{ mA to }800\text{ mA}$		0.0005	0.0025	%/mA
$V_{DROP}$	Dropout voltage	$I_{OUT} = 800\text{ mA } V_{BIAS} = 4.8\text{ V},$ $V_{OUT} = 3.3\text{ V}$		100		mV
		$40\text{ }^\circ\text{C} < T_J < 125\text{ }^\circ\text{C}$			150	
eN	Output noise voltage	10 Hz to 100 kHz, $I_{OUT} = 10\text{ mA},$ $V_{OUT} = 3.3\text{ V}$		200		$\mu\text{V}_{RMS}$
SVR	Supply voltage rejection	$V_{IN} > V_{OUT} + 0.5\text{ V } \pm V_{RIPPLE}$ $V_{RIPPLE} = 0.1\text{ V } f = 100\text{ Hz}$		70		dB
		$f = 10\text{ kHz}$		53		
		$f = 1\text{ MHz}$		30		
$I_{GND}$	Ground current	$I_{OUT} = 0\text{ mA } T_J = 25\text{ }^\circ\text{C}$		40		$\mu\text{A}$
		$I_{OUT} = 500\text{ mA } T_J = 25\text{ }^\circ\text{C}$		50		
		$I_{OUT} = 800\text{ mA } 40\text{ }^\circ\text{C} < T_J < 125\text{ }^\circ\text{C}$		50	150	
$I_{SC}$	Short-circuit current	$R_L = 0$		1.8		A
$V_{EN}$	Enable input logic low				0.8	V
	Enable input logic high		1.3			
$I_{EN}$	Enable pin input current	$V_{EN} = 1.3\text{ V}$			1	$\mu\text{A}$
PG	Power Good output threshold	Rising edge		$0.92 * V_{OUT}$		V
		Falling edge		$0.8 * V_{OUT}$		
	Power Good output voltage low	$I_{sink} = 6\text{ mA open drain output}$				0.4
$T_{SHDN}$	Thermal shutdown			165		$^\circ\text{C}$
	Hysteresis			20		

1. Important: in any case  $V_{BIAS} \geq V_{OUT} + 1.5\text{ V}$ .

## 6 Application information

### 6.1 Thermal and short-circuit protections

The ST1L08 is self-protected from short-circuit condition and overtemperature. When the output load is higher than the one supported by the device, the output current increases until the limit of typically 1.8 A is reached, at this point the current is kept constant even when the load impedance is zero.

Thermal protection acts when the junction temperature reaches 165 °C typical. At this point the output of the IC shuts down. As soon as the junction temperature falls below the thermal hysteresis value the device starts working again.

In order to calculate the maximum power that the device can dissipate, keeping the junction temperature below the TOP, the following formula is used:

#### Equation 1

$$P_{\text{DMAX}} = (125 - T_{\text{AMB}}) / R_{\text{THJA}}$$

### 6.2 Output voltage setting for ADJ version

In the adjustable version, the output voltage can be set from 0.5 V up to 4 V, by connecting a resistor divider between the ADJ pin and the output, thus allowing remote voltage sensing.

The resistor divider should be selected using the following equation:

#### Equation 2

$$V_{\text{OUT}} = V_{\text{ADJ}} (1 + R1 / R2), \text{ with } V_{\text{ADJ}} = 0.5 \text{ V (typ.)}$$

The resistors to be used, should have values in the range from 10 kΩ to 100 kΩ.

Lower values can also be suitable, but they increase current consumption.

### 6.3 Bias pin voltage requirements

The bias input is designed for low drop applications. The bias pin must be at least 2.7 V, and at least 1.5 V higher than the output, to ensure proper biasing to the N-channel power pass transistor.

If  $V_{\text{IN}}$  supply voltage meets these requirements, the bias pin can be tied to  $V_{\text{IN}}$ .

### 6.4 External capacitors requirements

The regulator is designed to be stable with ultra low ESR ceramic capacitors on the input and the output. The suggested minimum value of the input, bias and output capacitors is 1 μF. The input capacitor must be connected as closer as possible to the  $V_{\text{IN}}$  terminal. The output capacitor must also be connected as closer as possible to the output pin.



## 7 Typical characteristics

$T_J = 25\text{ }^\circ\text{C}$ ,  $V_{IN} = 1.5\text{ V}$ ,  $V_{BIAS} = 3.6\text{ V}$ ,  $V_{OUT} = V_{ADJ}$ ,  $C_{IN} = C_{BIAS} = 1\text{ }\mu\text{F}$ ,  $C_{OUT} = 4.7\text{ }\mu\text{F}$ ,  $V_{EN} = V_{BIAS}$ , unless otherwise specified.

**Figure 4. Output voltage vs. temperature (adjustable,  $I_{OUT} = 1\text{ mA}$ )**

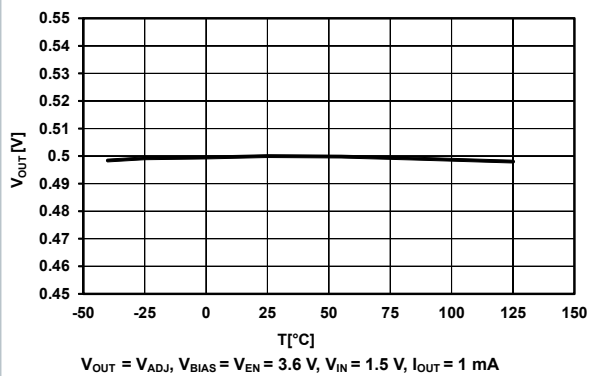

GIPG200620141502RV

**Figure 5. Output voltage vs. temperature (fixed 3.3 V,  $I_{OUT} = 1\text{ mA}$ )**

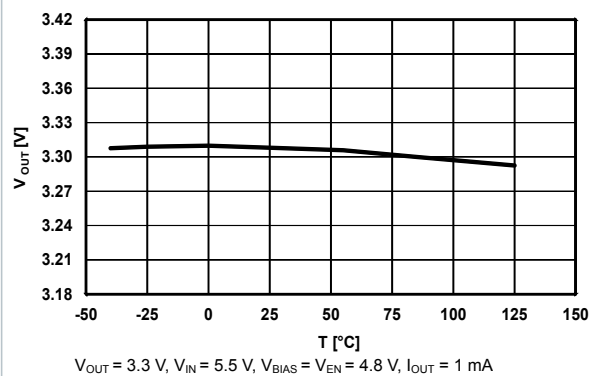

GIPG200620141539RV

**Figure 6. Output voltage vs. temperature (adjustable,  $I_{OUT} = 800\text{ mA}$ )**

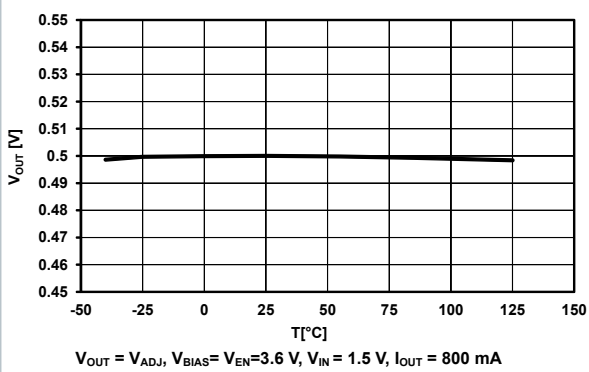

GIPG200620141526RV

**Figure 7. Output voltage vs. temperature (fixed 3.3 V,  $I_{OUT} = 800\text{ mA}$ )**

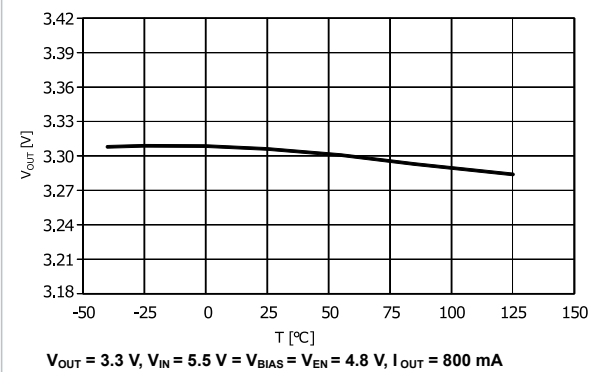

GIPG200620141548RV

**Figure 8.  $V_{IN}$  line regulation vs. temperature (adjustable)**

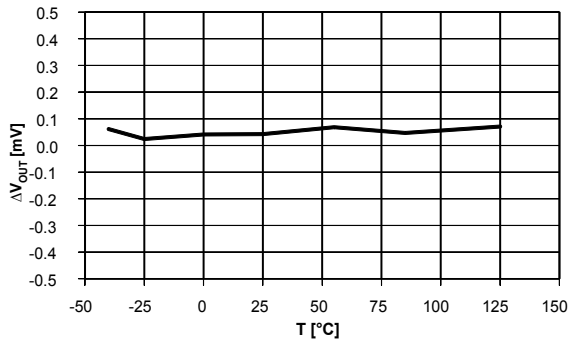

$V_{IN} = 1.0$  to  $5.5$  V,  $V_{BIAS} = 3.6$  V,  $I_{OUT} = 1$  mA,  $V_{OUT} = 0.5$  V

GIPG200620141601RV

**Figure 9.  $V_{BIAS}$  line regulation vs. temperature (adjustable)**

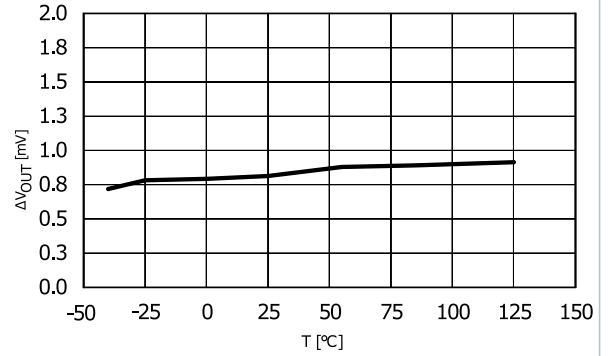

$V_{IN} = 1.0$  V,  $V_{BIAS} = 2.7$  to  $5.5$  V,  $I_{OUT} = 100$  mA,  $V_{OUT} = 0.5$  V

GIPG200620141606RV

**Figure 10. Load regulation vs. temperature (adjustable)**

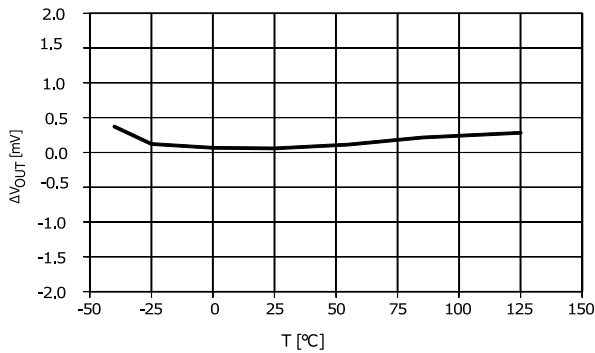

$V_{IN} = 1.5$  V,  $V_{BIAS} = 3.6$  V,  $I_{OUT} = 1$  mA to  $0.8$  A

GIPG200620141616RV

**Figure 11. Ground current vs. temperature (adjustable,  $I_{OUT} = 0$  mA)**

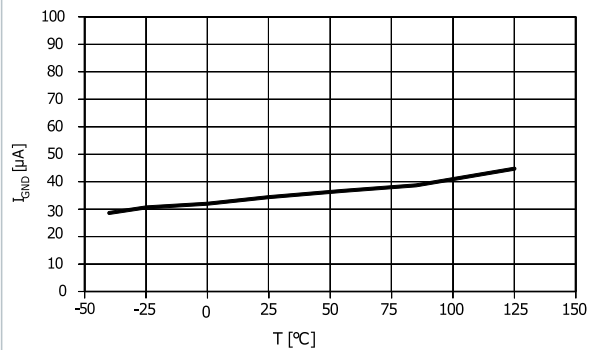

$V_{IN} = 1.5$  V,  $V_{BIAS} = 3.6$  V,  $I_{OUT} = 0$  mA

GIPG200620141623RV

**Figure 12. Ground current vs. temperature (adjustable,  $I_{OUT} = 500$  mA)**

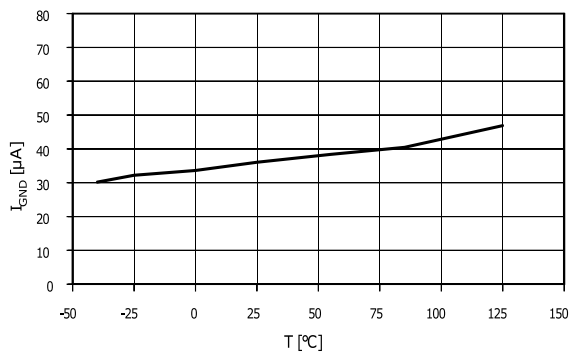

$V_{IN} = 1.5$  V,  $V_{BIAS} = 3.6$  V,  $I_{OUT} = 500$  mA

GIPG200620141641RV

**Figure 13. Ground current vs. temperature (adjustable,  $I_{OUT} = 800$  mA)**

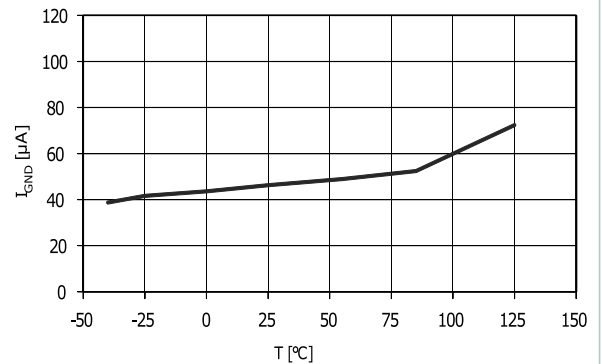

$V_{IN} = 5.5$  V,  $V_{BIAS} = 5.5$  V,  $I_{OUT} = 800$  mA

GIPG200620141649RV

**Figure 14. Ground current in off mode vs. temperature (adjustable)**

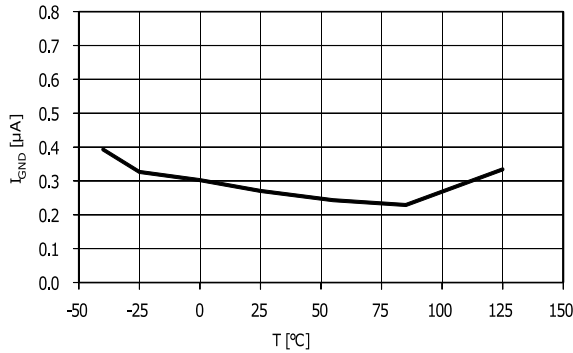

V<sub>IN</sub> = 1.5 V, V<sub>BIAS</sub> = 3.6 V, V<sub>EN</sub> = 0 V, I<sub>OUT</sub> = 0 mA

GIPG240620141112RV

**Figure 15. Ground current vs. output current (adjustable)**

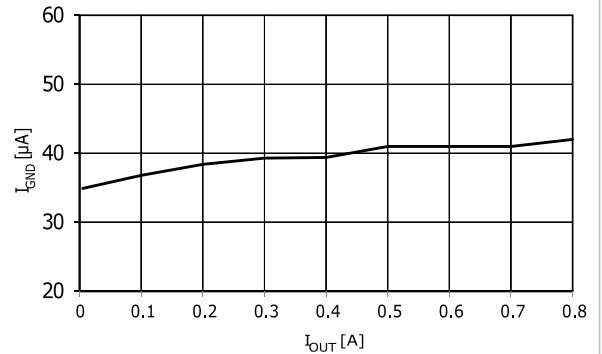

V<sub>IN</sub> = 1.5 V, V<sub>BIAS</sub> = V<sub>EN</sub> = 3.6 V, V<sub>OUT</sub> = V<sub>ADJ</sub>, T = 25 °C

GIPG240620141121RV

**Figure 16. Dropout voltage vs. temperature (adjustable)**

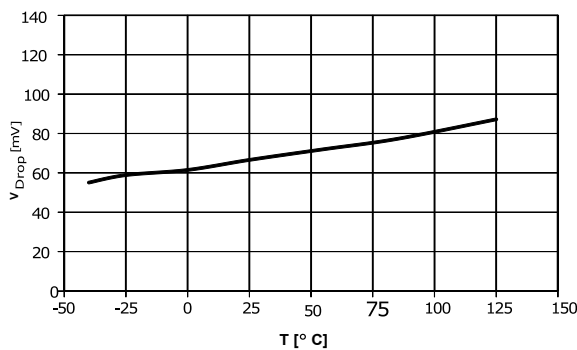

V<sub>BIAS</sub> = V<sub>EN</sub> = 3.6 V, I<sub>OUT</sub> = 800 mA

GIPG240620141129RV

**Figure 17. Dropout voltage temperature (fixed 3.3 V)**

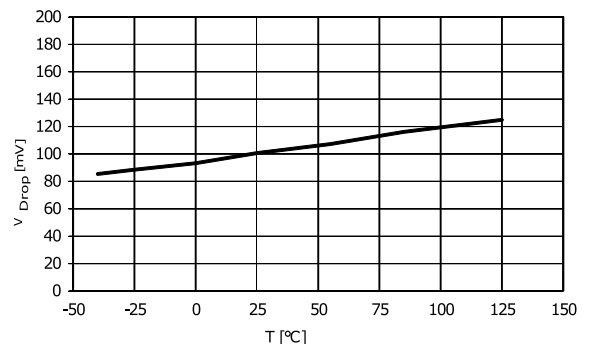

V<sub>BIAS</sub> = V<sub>EN</sub> = 3.6 V, I<sub>OUT</sub> = 800 mA

GIPG2406201451141RV

**Figure 18. Dropout voltage vs. output current**

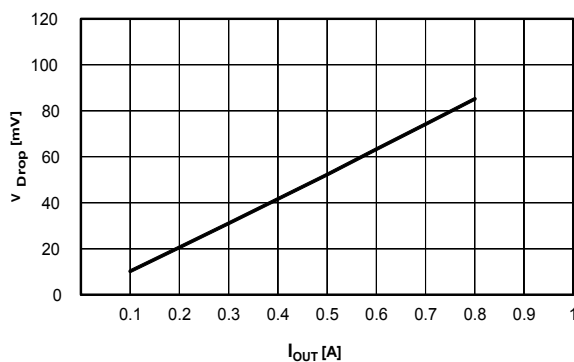

V<sub>BIAS</sub> = V<sub>EN</sub> = 5.5 V, V<sub>OUT</sub> = 3.9 V, T = 25 °C

GIPG240620141148RV

**Figure 19. Supply voltage rejection vs. frequency**

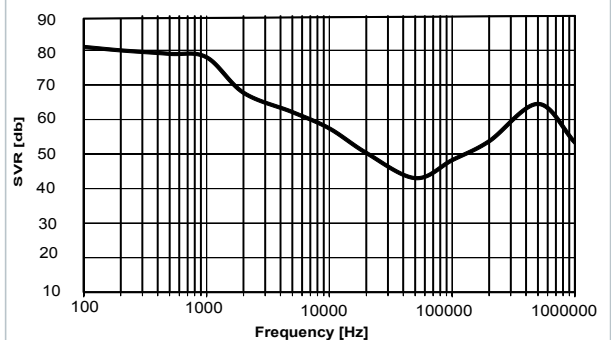

V<sub>OUT</sub> = V<sub>ADJ</sub>, V<sub>IN</sub> = 1 V±0.1 V Ripple, V<sub>EN</sub> = High, V<sub>BIAS</sub> = 3.6 V,  
T = 25 °C, I<sub>OUT</sub> = 100 mA, C<sub>IN</sub> = C<sub>BIAS</sub> = 1 µF, C<sub>OUT</sub> = 10 µF

GIPG240620141153RV

Figure 20. Output noise spectral density

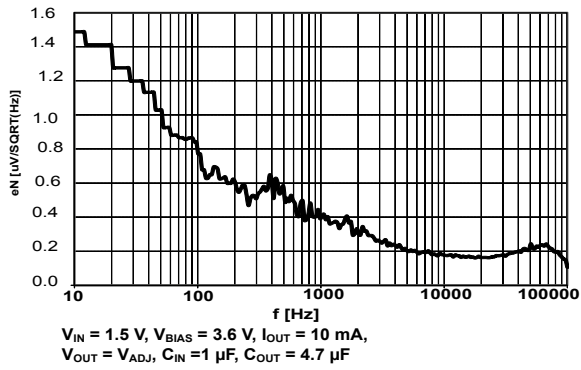

GIPG240620141159RV

Figure 21. Stability area vs. ( $C_{OUT}$ , ESR)

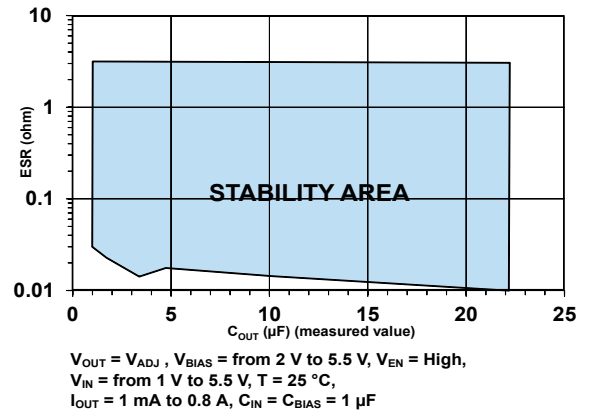

GIPG240620141205RV

Figure 22.  $V_{IN}$  line transient

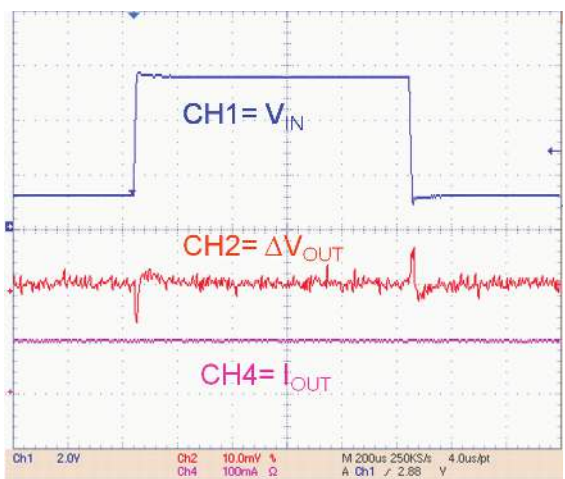

GIPD201020150847MT

Figure 23.  $V_{BIAS}$  line transient

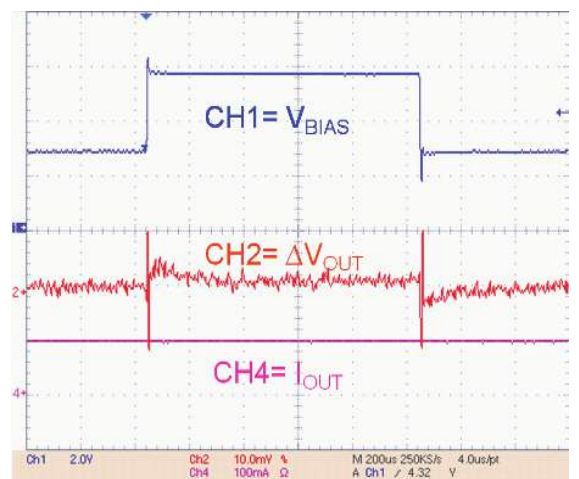

GIPD201020150848MT

Figure 24. Load transient,  $C_{OUT} = 4.7 \mu F$

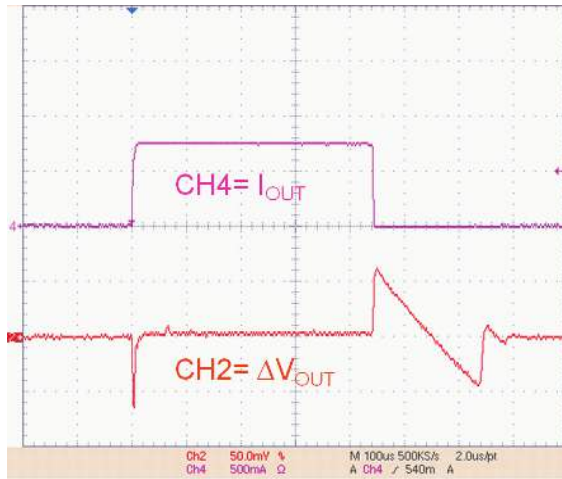

$V_{OUT} = V_{ADJ}$ ,  $V_{IN} = 1V$ ,  $V_{BIAS} = 2.7V$ ,  $I_{OUT}$  = from 5mA to 800mA,  $C_{OUT} = 4.7\mu F$

GIPD201020150849MT

Figure 25. Load transient,  $C_{OUT} = 1 \mu F$

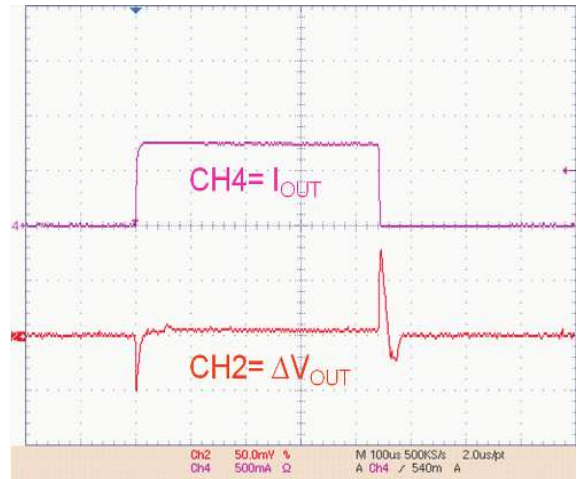

$V_{OUT} = V_{ADJ}$ ,  $V_{IN} = 1V$ ,  $V_{BIAS} = 2.7V$ ,  $I_{OUT}$  = from 5mA to 800mA,  $C_{OUT} = 1\mu F$

GIPD201020150850MT

Figure 26. Enable transient,  $V_{BIAS}$  before  $V_{IN}$

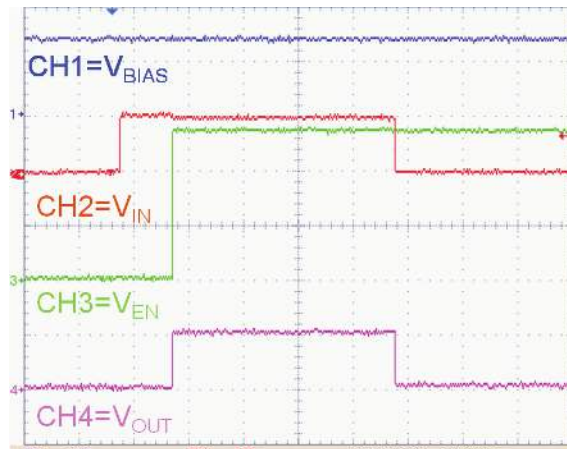

$V_{OUT} = V_{ADJ}$ ,  $V_{EN} = V_{BIAS}$  = from 0 to 2.7V,  $V_{IN}$  = from 0 to 1V,  $I_{OUT} = 800mA$ ,  $t_{RISE} = 1\mu s$

GIPD201020150851MT

Figure 27. Enable transient  $V_{IN}$  before  $V_{BIAS}$

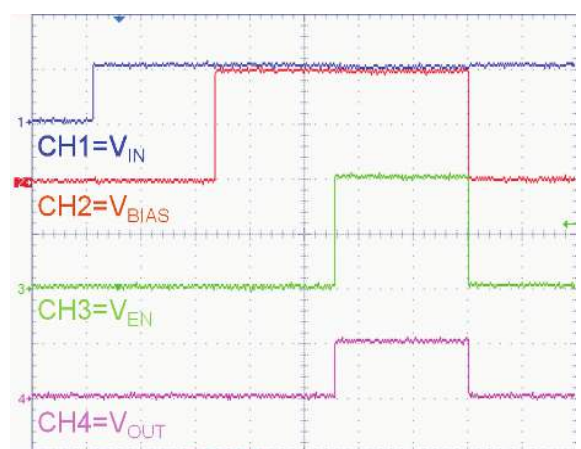

$V_{OUT} = V_{ADJ}$ ,  $V_{IN}$  = from 0 to 1V,  $V_{EN} = V_{BIAS}$  = from 0 to 2V,  $I_{OUT} = 800mA$ ,  $t_{RISE} = 10\mu s$

GIPD201020150852MT

## 8 Package information

In order to meet environmental requirements, ST offers these devices in different grades of **ECOPACK** packages, depending on their level of environmental compliance. ECOPACK specifications, grade definitions and product status are available at: [www.st.com](http://www.st.com). ECOPACK is an ST trademark.

### 8.1 DFN8 (2x3 mm) package information

Figure 28. DFN8 (2x3 mm) package outline

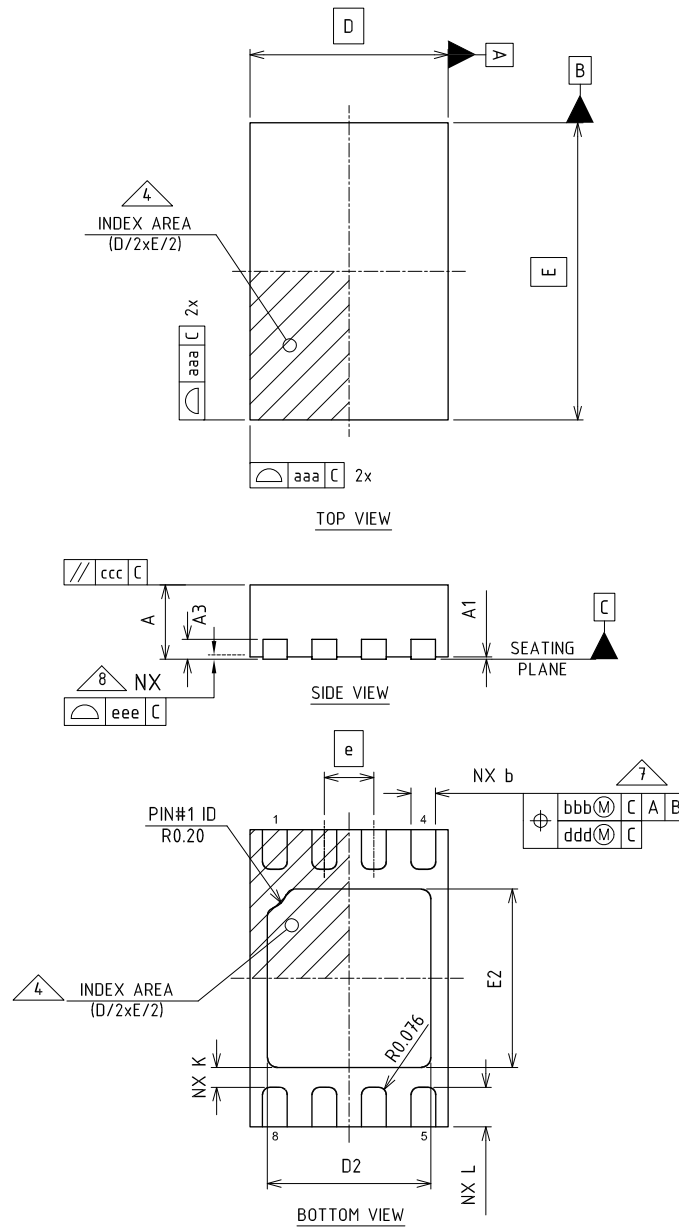

**Table 5. DFN8 (2x3 mm) mechanical data**

Dim.	mm		
	Min.	Typ.	Max.
A	0.80	0.90	1.00
A	0.80	0.90	1.00
A1	0.0	0.02	0.05
A3	0.203 Ref.		
b	0.18	0.25	0.30
D	1.90	2.00	2.10
E	2.90	3.00	3.10
e	0.50BSC		
D2	1.50	1.65	1.75
E2	1.65	1.80	1.90
K	0.20	-	-
L	0.30	0.40	0.50
N	8		
ND	4		
<b>TOLERANCE OF FORM AND POSITION</b>			
aaa	0.05		
bbb	0.10		
ccc	0.10		
ddd	0.05		
eee	0.08		

Figure 29. DFN8 (2x3 mm) recommended footprint

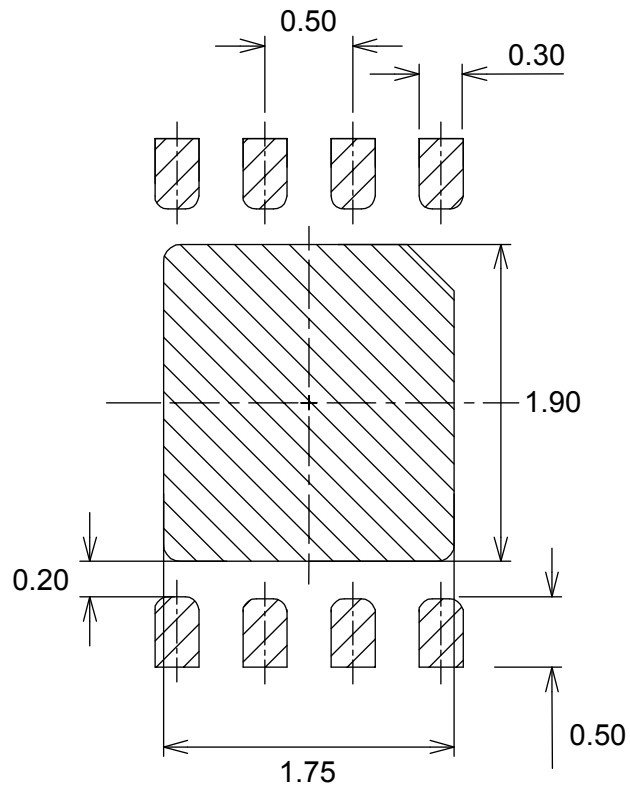



## 8.2 DFN8 (2x3 mm) packing information

Figure 30. DFN8 (2x3 mm) reel outline

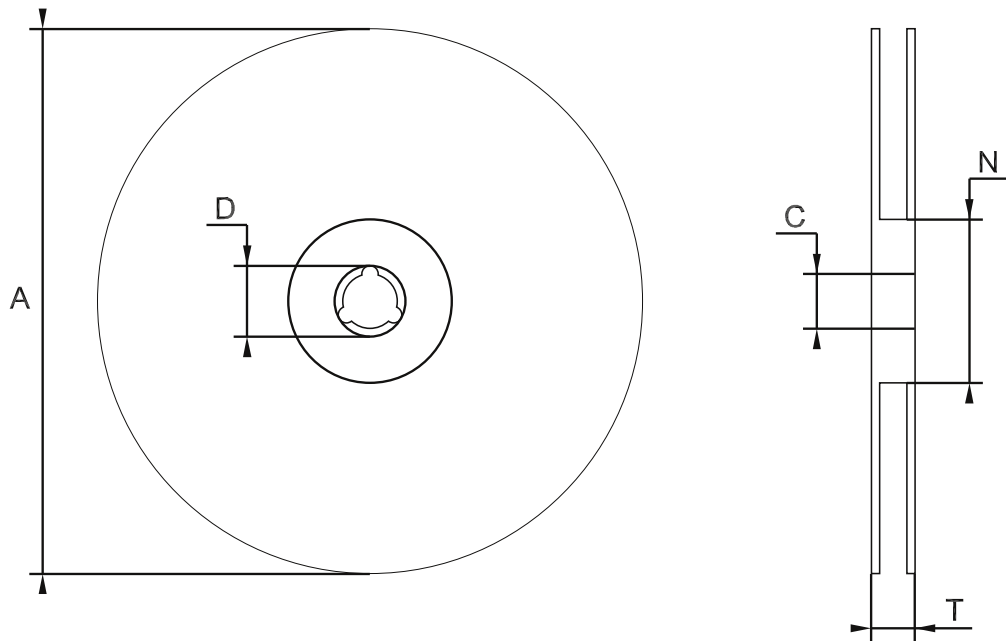
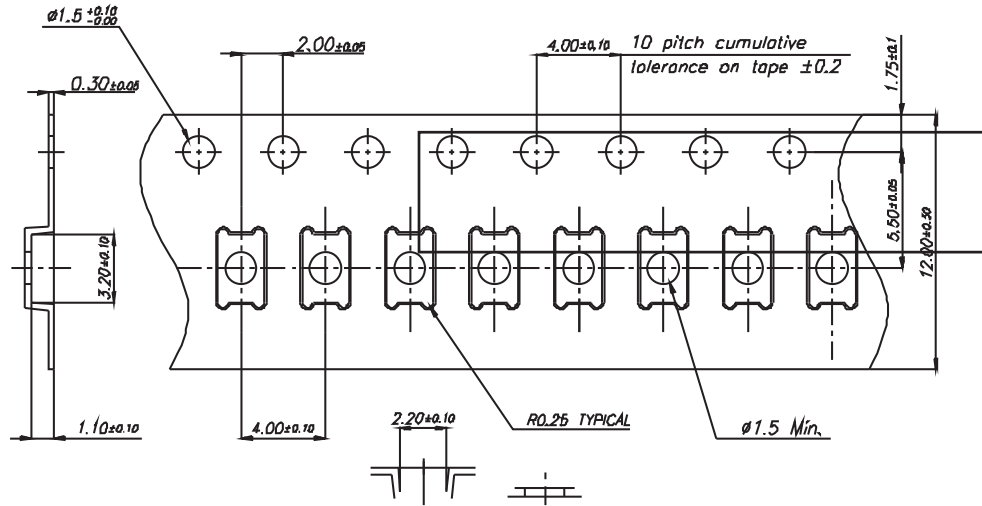

Table 6. DFN8 (2x3 mm) tape and reel mechanical data

Dim.	mm		
	Min.	Typ.	Max.
A			180
C		12.8	13.2
D		20.2	
N		60	
T			14.4

**Figure 31. DFN8 (2x3 mm) tape outline**

## 9 Ordering information

**Table 7. Order codes**

Order code	Power Good and $V_{IN}$ control	Package	Output voltages
ST1L08SPU12R	Yes	DFN8 (2x3 mm)	1.2 V
ST1L08SPU33R	Yes		3.3 V
ST1L08SPUR	Yes		Adjustable
ST1L08PUR	No		Adjustable

## Revision history

**Table 8. Document revision history**

Date	Revision	Changes
23-Oct-2014	1	First release.
16-Nov-2015	2	Updated Table 5: "Electrical characteristics for the ST1L08 (adjustable)". Minor text changes.
17-Nov-2020	3	Updated Section 8.1 DFN8 (2x3 mm) package information.

## List of tables

<b>Table 1.</b>	Pin description . . . . .	3
<b>Table 2.</b>	Absolute maximum ratings . . . . .	5
<b>Table 3.</b>	Thermal data . . . . .	5
<b>Table 4.</b>	Electrical characteristics for the ST1L08 (adjustable) . . . . .	6
<b>Table 5.</b>	DFN8 (2x3 mm) mechanical data . . . . .	15
<b>Table 6.</b>	DFN8 (2x3 mm) tape and reel mechanical data . . . . .	17
<b>Table 7.</b>	Order codes . . . . .	19
<b>Table 8.</b>	Document revision history . . . . .	20

## List of figures

<b>Figure 1.</b>	Block diagram . . . . .	2
<b>Figure 2.</b>	Pin connection (top view) . . . . .	3
<b>Figure 3.</b>	Typical application circuits . . . . .	4
<b>Figure 4.</b>	Output voltage vs. temperature (adjustable, $I_{OUT} = 1 \text{ mA}$ ) . . . . .	9
<b>Figure 5.</b>	Output voltage vs. temperature (fixed 3.3 V, $I_{OUT} = 1 \text{ mA}$ ) . . . . .	9
<b>Figure 6.</b>	Output voltage vs. temperature (adjustable, $I_{OUT} = 800 \text{ mA}$ ) . . . . .	9
<b>Figure 7.</b>	Output voltage vs. temperature (fixed 3.3 V, $I_{OUT} = 800 \text{ mA}$ ) . . . . .	9
<b>Figure 8.</b>	$V_{IN}$ line regulation vs. temperature (adjustable) . . . . .	10
<b>Figure 9.</b>	$V_{BIAS}$ line regulation vs. temperature (adjustable) . . . . .	10
<b>Figure 10.</b>	Load regulation vs. temperature (adjustable) . . . . .	10
<b>Figure 11.</b>	Ground current vs. temperature (adjustable, $I_{OUT} = 0 \text{ mA}$ ) . . . . .	10
<b>Figure 12.</b>	Ground current vs. temperature (adjustable, $I_{OUT} = 500 \text{ mA}$ ) . . . . .	10
<b>Figure 13.</b>	Ground current vs. temperature (adjustable, $I_{OUT} = 800 \text{ mA}$ ) . . . . .	10
<b>Figure 14.</b>	Ground current in off mode vs. temperature (adjustable) . . . . .	11
<b>Figure 15.</b>	Ground current vs. output current (adjustable) . . . . .	11
<b>Figure 16.</b>	Dropout voltage vs. temperature (adjustable) . . . . .	11
<b>Figure 17.</b>	Dropout voltage temperature (fixed 3.3 V) . . . . .	11
<b>Figure 18.</b>	Dropout voltage vs. output current . . . . .	11
<b>Figure 19.</b>	Supply voltage rejection vs. frequency . . . . .	11
<b>Figure 20.</b>	Output noise spectral density . . . . .	12
<b>Figure 21.</b>	Stability area vs. ( $C_{OUT}$ , ESR) . . . . .	12
<b>Figure 22.</b>	$V_{IN}$ line transient . . . . .	12
<b>Figure 23.</b>	$V_{BIAS}$ line transient . . . . .	12
<b>Figure 24.</b>	Load transient, $C_{OUT} = 4.7 \mu\text{F}$ . . . . .	13
<b>Figure 25.</b>	Load transient, $C_{OUT} = 1 \mu\text{F}$ . . . . .	13
<b>Figure 26.</b>	Enable transient, $V_{BIAS}$ before $V_{IN}$ . . . . .	13
<b>Figure 27.</b>	Enable transient $V_{IN}$ before $V_{BIAS}$ . . . . .	13
<b>Figure 28.</b>	DFN8 (2x3 mm) package outline . . . . .	14
<b>Figure 29.</b>	DFN8 (2x3 mm) recommended footprint . . . . .	16
<b>Figure 30.</b>	DFN8 (2x3 mm) reel outline . . . . .	17
<b>Figure 31.</b>	DFN8 (2x3 mm) tape outline . . . . .	18

**IMPORTANT NOTICE – PLEASE READ CAREFULLY**

STMicroelectronics NV and its subsidiaries (“ST”) reserve the right to make changes, corrections, enhancements, modifications, and improvements to ST products and/or to this document at any time without notice. Purchasers should obtain the latest relevant information on ST products before placing orders. ST products are sold pursuant to ST’s terms and conditions of sale in place at the time of order acknowledgement.

Purchasers are solely responsible for the choice, selection, and use of ST products and ST assumes no liability for application assistance or the design of Purchasers’ products.

No license, express or implied, to any intellectual property right is granted by ST herein.

Resale of ST products with provisions different from the information set forth herein shall void any warranty granted by ST for such product.

ST and the ST logo are trademarks of ST. For additional information about ST trademarks, please refer to [www.st.com/trademarks](http://www.st.com/trademarks). All other product or service names are the property of their respective owners.

Information in this document supersedes and replaces information previously supplied in any prior versions of this document.

© 2020 STMicroelectronics – All rights reserved