

Features

- Surface mount
- 2:1 Impedance ratio
- Centre tap on secondary
- Suitable for DOCSIS 3.1
- RoHS compliant and Pb free
- Available on tape and reel

Description

The MABA-011056 is a 2:1 step down flux coupled balun transformer in a low cost surface mount package. Ideally suited for CATV Broadband applications.

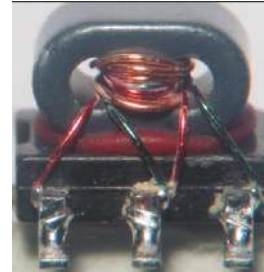

Functional Schematic

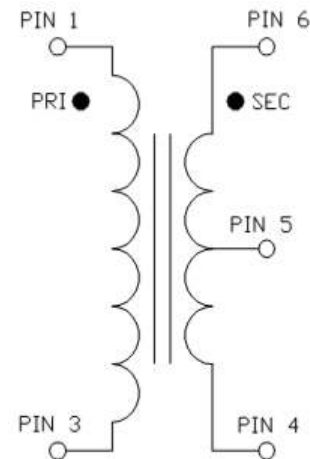

Ordering Information

Part Number	Package
MABA-011056	Tape & Reel
MABA-011056-TB	Customer test board

Pin Configuration

Pin No.	Function
1	Primary Dot
3	Primary
4	Secondary
5	Secondary Centre Tap
6	Secondary Dot

Transformer, 2:1 Flux Coupled Transformer 5 - 300 MHz

Rev. V2

Electrical Specifications: Freq. = 5 - 300 MHz, $T_A = 25^\circ\text{C}$, $Z_0 = 75 \Omega$, $P_{IN} = 0 \text{ dBm}$

Parameter	Conditions	Units	Min.	Typ.	Max.
Impedance Ratio	—	—	—	2:1	—
Insertion Loss (Pin 1 - Pin 6)	5 - 50 MHz	dB	—	0.4	0.6
	50 - 85 MHz			0.5	0.7
	85 - 205 MHz			0.8	1.5
	205 - 300 MHz			1.3	2.2
Insertion Loss (Pin 1 - Pin 4)	5 - 50 MHz	dB	—	0.4	0.6
	50 - 85 MHz			0.5	0.7
	85 - 205 MHz			0.7	1.4
	205 - 300 MHz			1.2	2.0
Amplitude Balance	5 - 50 MHz	dB	—	0.02	0.2
	50 - 85 MHz			0.04	0.3
	85 - 205 MHz			0.04	0.5
	205 - 300 MHz			0.1	0.7
Phase Balance	5 - 50 MHz	°	—	0.1	2.0
	50 - 85 MHz			0.3	3.0
	85 - 205 MHz			1.1	6.0
	205 - 300 MHz			1.2	7.0
Input Return Loss (Pin 1)	5 - 45 MHz	dB	20	25	—
	45 - 85 MHz		15	19	
	85 - 205 MHz		8	13	
	205 - 300 MHz		6	9	

Absolute Maximum Ratings

Parameter	Units
Input RF Power	0.5 W
DC Current	500 mA
Operating Temperature	-40°C to +85°C

Application Circuit

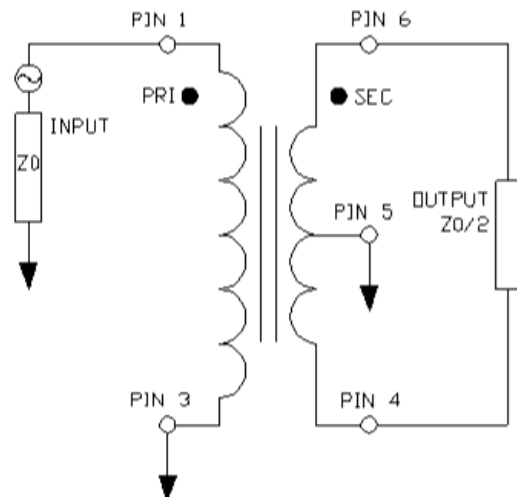

Typical Performance Curves

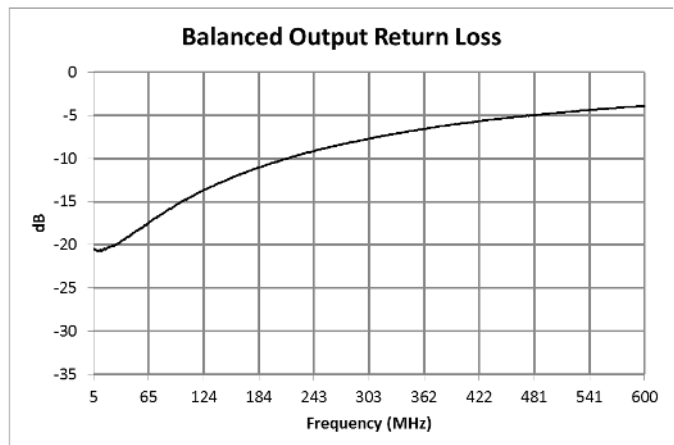
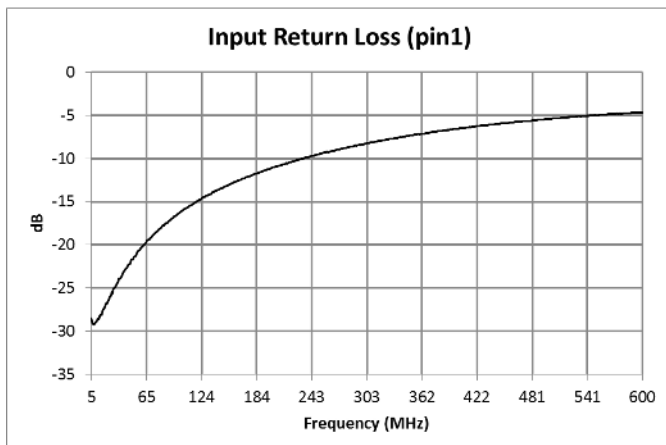
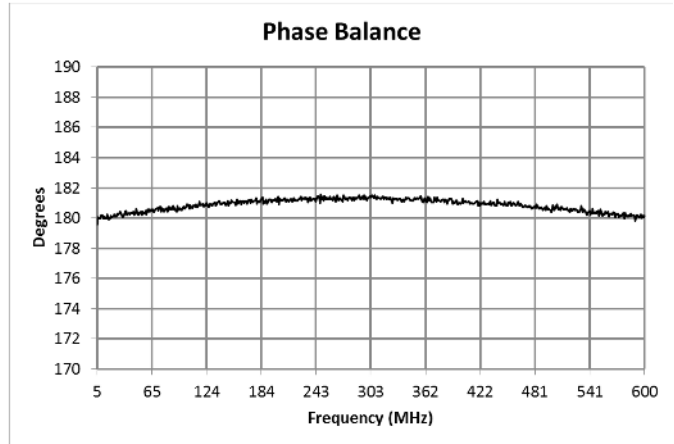
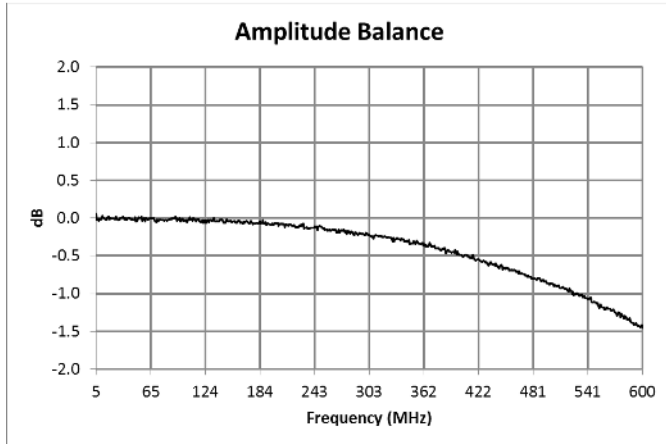
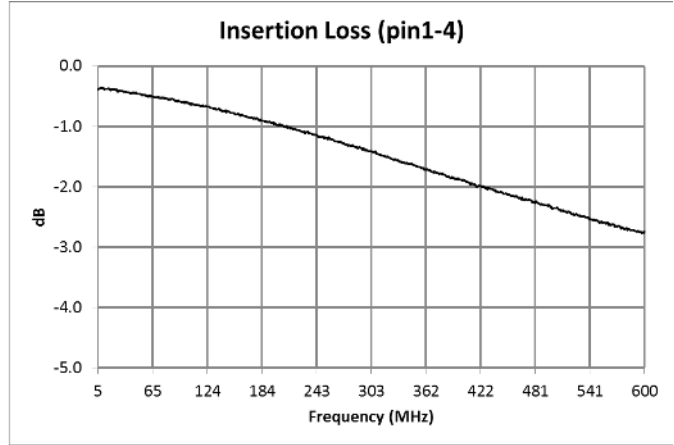
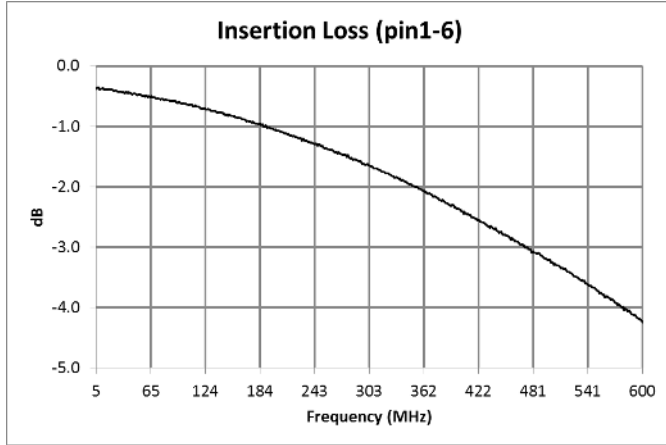

Full temperature plots available on request

Outline Drawing

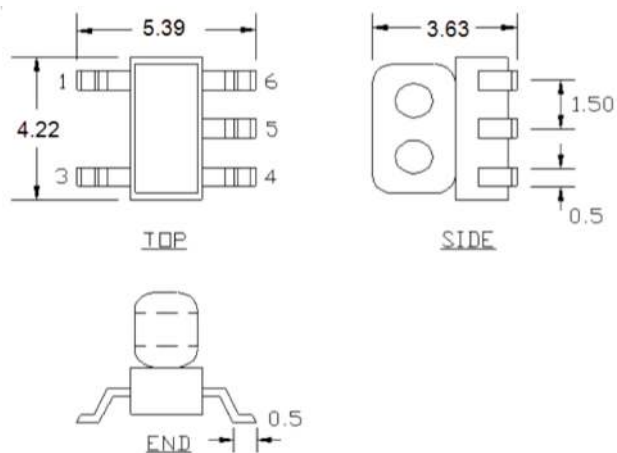

1. Dimensions in mm.
2. Tolerance: ± 0.2 mm unless otherwise noted.
3. Model number and lot code are printed on the reel.
4. Lead finish SAC-305.

PCB Layout

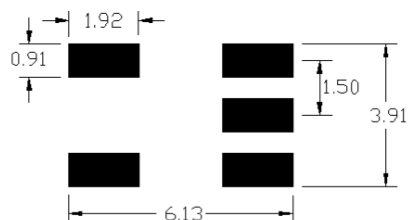

Tape & Reel Information

Parameter	Units	Value
Qty per reel	-	2000
Reel size	mm	330
Tape width (W)	mm	12.00
Pitch (P1)	mm	8.00
A ₀	mm	5.6
B ₀	mm	4.5
K ₀	mm	4.0
Orientation	-	F26
Reference Application note ANI-019 for orientation		

MACOM Technology Solutions Inc. All rights reserved.

Information in this document is provided in connection with MACOM Technology Solutions Inc ("MACOM") products. These materials are provided by MACOM as a service to its customers and may be used for informational purposes only. Except as provided in MACOM's Terms and Conditions of Sale for such products or in any separate agreement related to this document, MACOM assumes no liability whatsoever. MACOM assumes no responsibility for errors or omissions in these materials. MACOM may make changes to specifications and product descriptions at any time, without notice. MACOM makes no commitment to update the information and shall have no responsibility whatsoever for conflicts or incompatibilities arising from future changes to its specifications and product descriptions. No license, express or implied, by estoppel or otherwise, to any intellectual property rights is granted by this document.

THESE MATERIALS ARE PROVIDED "AS IS" WITHOUT WARRANTY OF ANY KIND, EITHER EXPRESS OR IMPLIED, RELATING TO SALE AND/OR USE OF MACOM PRODUCTS INCLUDING LIABILITY OR WARRANTIES RELATING TO FITNESS FOR A PARTICULAR PURPOSE, CONSEQUENTIAL OR INCIDENTAL DAMAGES, MERCHANTABILITY, OR INFRINGEMENT OF ANY PATENT, COPYRIGHT OR OTHER INTELLECTUAL PROPERTY RIGHT. MACOM FURTHER DOES NOT WARRANT THE ACCURACY OR COMPLETENESS OF THE INFORMATION, TEXT, GRAPHICS OR OTHER ITEMS CONTAINED WITHIN THESE MATERIALS. MACOM SHALL NOT BE LIABLE FOR ANY SPECIAL, INDIRECT, INCIDENTAL, OR CONSEQUENTIAL DAMAGES, INCLUDING WITHOUT LIMITATION, LOST REVENUES OR LOST PROFITS, WHICH MAY RESULT FROM THE USE OF THESE MATERIALS.

MACOM products are not intended for use in medical, lifesaving or life sustaining applications. MACOM customers using or selling MACOM products for use in such applications do so at their own risk and agree to fully indemnify MACOM for any damages resulting from such improper use or sale.