

Reflexlichtschranke mit Schmitt-Trigger Reflective Interrupter with Schmitt-Trigger

SFH 9240
SFH 9241

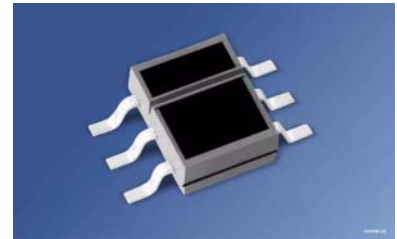

Wesentliche Merkmale

- IR-GaAs-Lumineszenzdiode in Kombination mit einem Schmitt-Trigger IC
- SFH 9240: Output active low
- SFH 9241: Output active high
- Tageslichtsperrfilter
- Einschaltstrom: typ. 3 mA
- Sender und Empfänger galvanisch getrennt

Anwendungen

- Optischer Schalter
- Pulsformer
- Zähler

Features

- IR-GaAs-emitter in combination with a Schmitt-Trigger IC
- SFH 9240: Output active low
- SFH 9241: Output active high
- Daylight cut-off filter
- Threshold current: typ. 3 mA
- Emitter and detector electrically isolated

Applications

- Optical threshold switch
- Pulseformer
- Counter

Typ Type	Bestellnummer Ordering Code	Gehäuse Package
SFH 9240	Q62702-P5118	P-DSO-6 Gehäuse mit Tageslichtsperrfilter, Anschlüsse im 1.27 mm - Raster, Ausgang: active low P-DSO-6 package with daylight-cutoff-filter, lead spacing 1.27 mm (1/20"), Output active low
SFH 9241	Q62702-P5119	P-DSO-6 Gehäuse mit Tageslichtsperrfilter, Anschlüsse im 1.27 mm - Raster, Ausgang: active high P-DSO-6 package with daylight cut-off filter, lead spacing 1.27 mm (1/20"), Output active high

Grenzwerte ($T_A = 25\text{ °C}$)**Maximum Ratings**

Bezeichnung Parameter	Symbol Symbol	Wert Value	Einheit Unit
Sender (GaAs-Diode) Emitter (GaAs diode)			
Sperrspannung Reverse voltage	V_R	5	V
Vorwärtsgleichstrom Forward current	I_F	50	mA
Stoßstrom ($t_p \leq 10\ \mu\text{s}$) Surge current ($t_p \leq 10\ \mu\text{s}$)	I_{FSM}	1.5	A
Verlustleistung Power dissipation	P_{tot}	80	mW

Empfänger (Schmitt-Trigger IC)**Detector** (Schmitt-Trigger IC)

Versorgungsspannung Supply voltage	V_{CC}	- 0.5 ... + 20	V
Ausgangsspannung Output voltage	V_O	- 0.5 ... + 20	V
Ausgangsstrom Output current ($T_A = 25\text{ °C}$)	I_O	20	mA
Verlustleistung Power dissipation	P_{tot}	100	mW

Reflexlichtschranke**Light Reflection Switch**

Betriebs- und Lagertemperatur Operating and storage temperature range	T_{op}, T_{stg}	- 40 ... + 100	°C
Verlustleistung Power dissipation	P_{tot}	150	mW

Kennwerte ($T_A = 25\text{ °C}$)

Characteristics

Bezeichnung Parameter	Symbol Symbol	Wert Value	Einheit Unit
Sender (GaAs-Diode)			
Emitter (GaAs diode)			
Durchlassspannung Forward voltage $I_F = 50\text{ mA}$	V_F	1.25 (≤ 1.65)	V
Sperrstrom Reverse current $V_R = 5\text{ V}$	I_R	0.01 (≤ 1)	μA
Kapazität Capacitance $V_R = 0\text{ V}, f = 1\text{ MHz}$	C_O	25	pF
Wärmewiderstand (Montage auf PC-Board mit > 5 mm ² Padgröße) Thermal resistance (mounting on pcb with > 5 mm ² pad size)	R_{thJA}	400	K/W

Empfänger (Schmitt-Trigger IC) (wenn nicht anders angegeben, $V_{CC} = 5\text{ V}$)

Detector (Schmitt-Trigger IC) (unless otherwise specified, $V_{CC} = 5\text{ V}$)

Ausgangsspannung „high“ Output voltage “high” $I_O = 0$	V_{OH}	$V_{CC} (> 4.0)$	V
Ausgangsspannung „low“ Output voltage “low” $I_O = 16\text{ mA}$	V_{OL}	0.15 (< 0.4)	V
Stromaufnahme Supply current $V_{CC} = 5\text{ V}$ $V_{CC} = 18\text{ V}$	I_{CC}	3.3 (< 5) 5.0	mA
Anstiegszeit 10% bis 90% Rise time 10% to 90% $R_L = 280\ \Omega, I_F = 20\text{ mA}$	t_r	SFH9240	SFH9241
		20	30
Abfallzeit 90% bis 10% Fall time 90% to 10% $R_L = 280\ \Omega, I_F = 20\text{ mA}$	t_f	SFH9240	SFH9241
		10	20

Kennwerte ($T_A = 25\text{ °C}$)**Characteristics** (cont'd)

Bezeichnung Parameter	Symbol Symbol	Wert Value	Einheit Unit
Ausgangsverzögerungszeit Propagation delay time "ON" $R_L = 280\ \Omega$, $I_F = 20\text{ mA}$	t_{ON}	1	μs
Ausgangsverzögerungszeit Propagation delay time "OFF" $R_L = 280\ \Omega$, $I_F = 20\text{ mA}$	t_{OFF}	2	μs

Reflexlichtschranke**Light Reflection Switch**

Schaltsschwelle Threshold current, Kodak neutral white test card with 90% reflection $V_{CC} = 5\text{ V}$, $d = 1\text{ mm}$	$I_{F, ON}$	3 (< 10)	mA
Hysterese Hysteresis	$I_{F, OFF} / I_{F, ON}$	0.6 (0.5 ... 0.9)	–

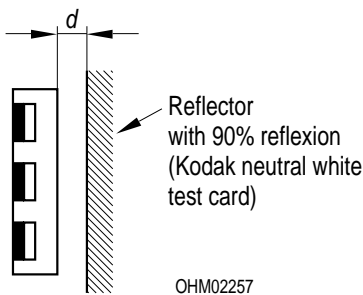
**Zulässiger Arbeitsbereich****Operating Conditions**

Bezeichnung Parameter	Symbol Symbol	Wert Value	Einheit Unit
Versorgungsspannung Supply voltage	V_{CC}	4 ... 18	V
Ausgangsstrom Output current	I_O	< 16	mA

Zur Stabilisierung der Versorgung wird ein Stützkondensator (angeschlossen zwischen V_{CC} und GND) von typ. $0.1\ \mu\text{F}$ empfohlen.

A bypass capacitor, $0.1\ \mu\text{F}$ typical, connected between V_{CC} and GND is recommended in order to stabilize power supply line.

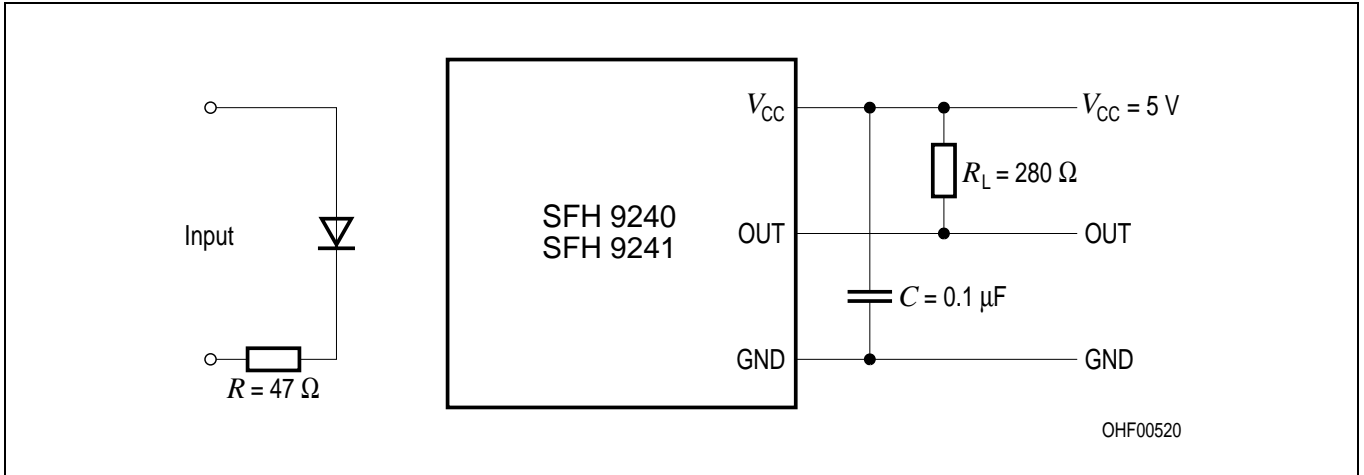

Figure 1 Test Circuit for Switching and Response Time

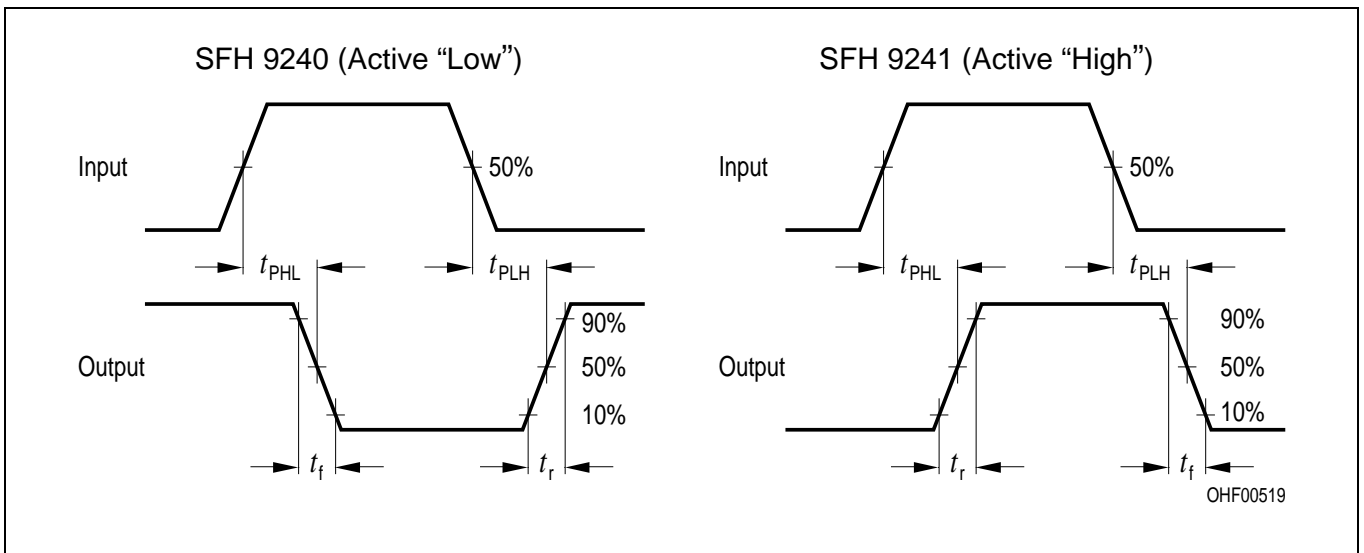
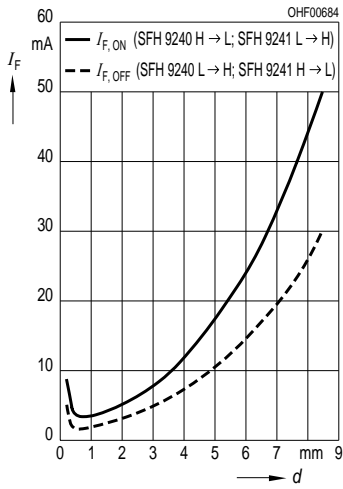
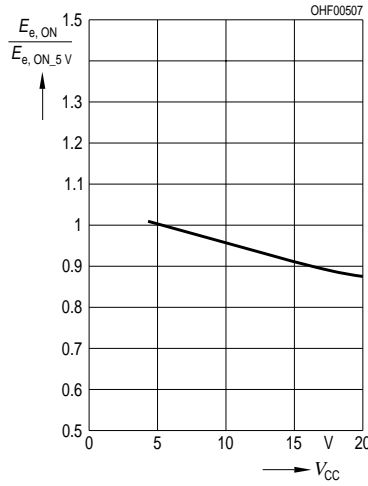

Figure 2 Switching Time Definitions

Threshold Current vs. Distance
 $I_F = f(d)$



Relative Threshold
 $E_{e,ON}/E_{e,ON VCC=5V} = f(V_{CC})$



Supply Current
 $I_{CC} = f(V_{CC})$

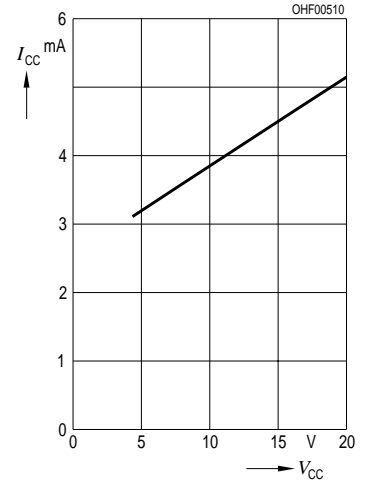

Output Voltage
 $V_{OL} = f(I_{OUT}, V_{CC})$

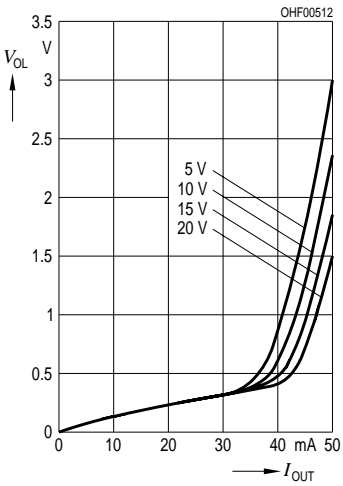

Supply Current vs. Ambient Temperature
 $I_{CC} = f(T_A, V_{CC})$

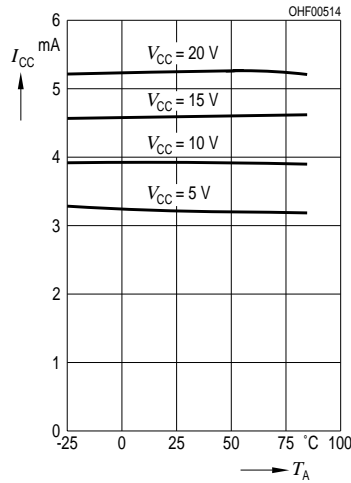

Maßzeichnung
Package Outlines

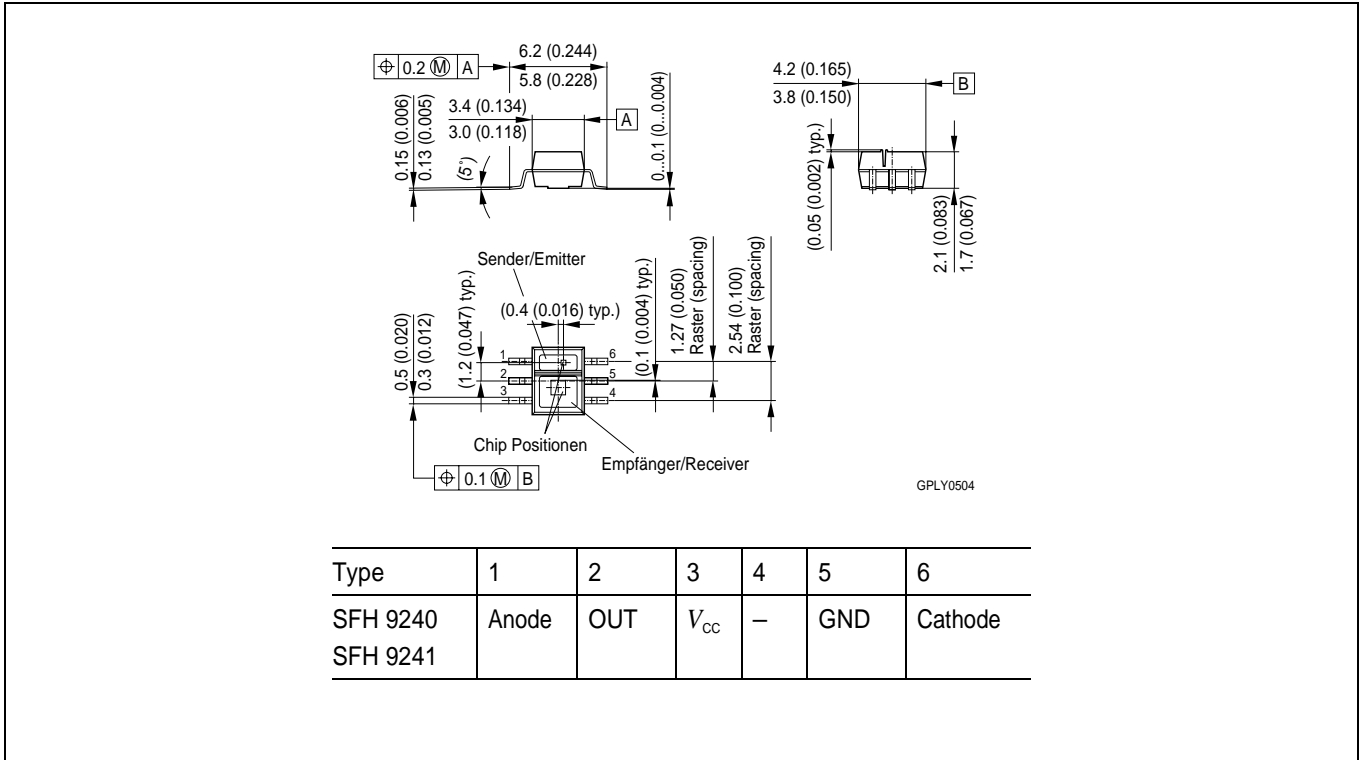

Maße werden wie folgt angegeben: mm (inch) / Dimensions are specified as follows: mm (inch).

Löthinweise
Soldering Conditions

Bauform Type	Drypack Level acc. to JEDEC A112-A	Tauch-, Schwalllötung Dip, Wave Soldering		Reflowlötung Reflow Soldering		Kolbenlötung Iron Soldering (Iron temp.)
		Peak Temp. (solderbath)	Max. Time in Peak Zone	Peak Temp. (package temp.)	Max. Time in Peak Zone	
SFH 9240 SFH 9241	4	n. a.	–	245 °C	10 sec.	n.a.

Bitte Verarbeitungshinweise für SMT-Bauelemente beachten!

Please observe the handling guidelines for SMT devices!

Published by OSRAM Opto Semiconductors GmbH & Co. OHG
 Wernerwerkstrasse 2, D-93049 Regensburg

© All Rights Reserved.

Attention please!

The information describes the type of component and shall not be considered as assured characteristics. Terms of delivery and rights to change design reserved. Due to technical requirements components may contain dangerous substances. For information on the types in question please contact our Sales Organization.

Packing

Please use the recycling operators known to you. We can also help you – get in touch with your nearest sales office. By agreement we will take packing material back, if it is sorted. You must bear the costs of transport. For packing material that is returned to us unsorted or which we are not obliged to accept, we shall have to invoice you for any costs incurred.

Components used in life-support devices or systems must be expressly authorized for such purpose! Critical components ¹, may only be used in life-support devices or systems ² with the express written approval of OSRAM OS.

¹ A critical component is a component used in a life-support device or system whose failure can reasonably be expected to cause the failure of that life-support device or system, or to affect its safety or effectiveness of that device or system.

² Life support devices or systems are intended (a) to be implanted in the human body, or (b) to support and/or maintain and sustain human life. If they fail, it is reasonable to assume that the health of the user may be endangered.