



TE Internal #: 1-2103124-2

PCB Mount Header, Vertical, Wire-to-Panel, 2 Position, 10.4 mm [.409 in] Centerline, Fully Shrouded, Gold / Silver, Sealable, Power & Signal, Natural

[View on TE.com >](#)

Connectors > PCB Connectors > PCB Headers & Receptacles

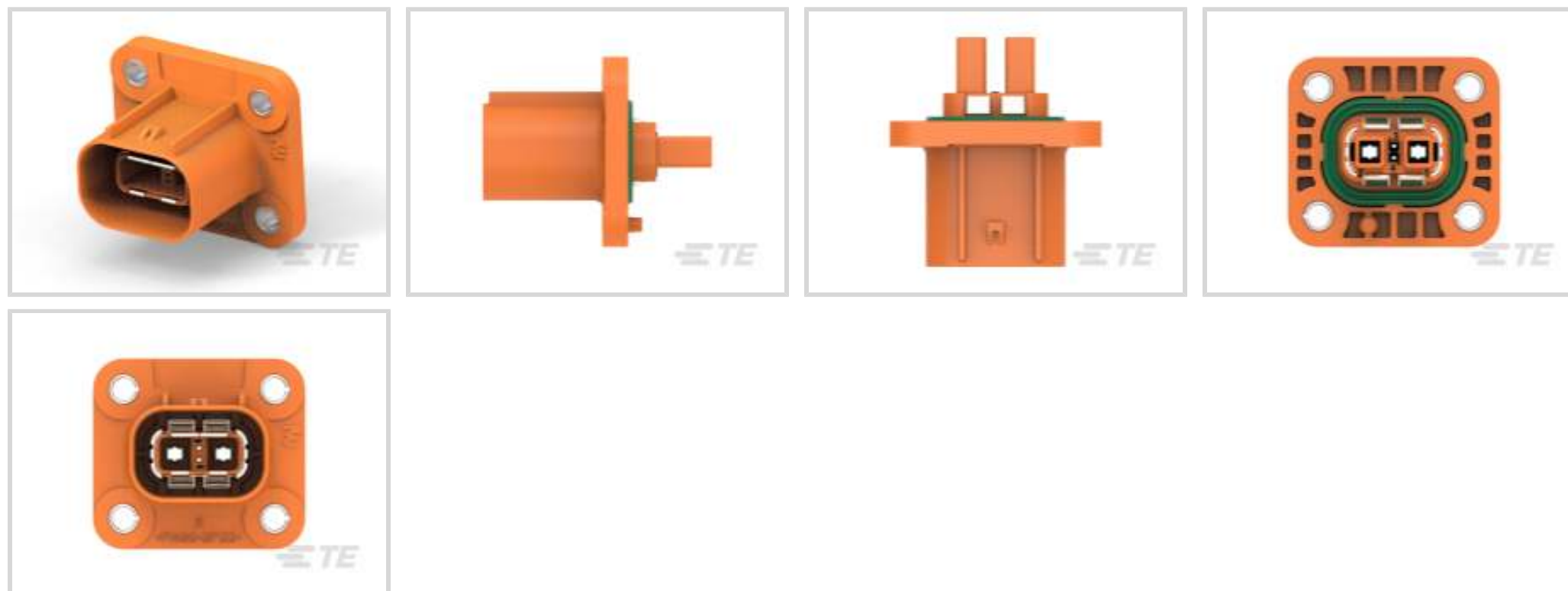

Connector System: **Wire-to-Panel**  
 Number of Positions: **2**  
 Centerline (Pitch): **10.4 mm [ .409 in ]**  
 Sealable: **Yes**  
 PCB Mount Orientation: **Vertical**

### Features

#### Product Type Features

Hybrid Header	No
Connector Shape	Rectangular
PCB Connector Assembly Type	PCB Mount Header
Header Type	Fully Shrouded
Connector System	Wire-to-Panel
Sealable	Yes
Connector & Contact Terminates To	Wire & Cable

#### Configuration Features

Number of Positions	2
PCB Mount Orientation	Vertical
Number of Rows	1

#### Body Features

Primary Product Color	Natural
Connector & Keying Code	B



### Contact Features

Contact Type	Tab
Mating Tab Width	.63 mm, 2.8 mm [.024 in][.11 in]
Mating Tab Thickness	.25 mm, .8 mm [.009 in][.031 in]
Contact Mating Area Plating Material	Gold, Silver
Contact Current Rating (Max)	7.5 A, 30 A

### Mechanical Attachment

Mating Alignment	With
Panel Mount Feature	With
Connector Mounting Type	Panel Mount

### Housing Features

Centerline (Pitch)	10.4 mm [.409 in]
--------------------	-------------------

### Usage Conditions

Operating Temperature Range	-40 – 140 °C [-40 – 284 °F]
-----------------------------	-----------------------------

### Operation/Application

Shielded	Yes
Circuit Application	Power & Signal

### Packaging Features

Packaging Type	Package
Packaging Quantity	1

### Product Compliance

[For compliance documentation, visit the product page on TE.com>](#)

EU RoHS Directive 2011/65/EU	Compliant
EU ELV Directive 2000/53/EC	Compliant
China RoHS 2 Directive MIIT Order No 32, 2016	No Restricted Materials Above Threshold
EU REACH Regulation (EC) No. 1907/2006	Current ECHA Candidate List: JUNE 2023 (235) Candidate List Declared Against: JUNE 2023 (235) SVHC > Threshold: Octamethylcyclotetrasiloxane (D4) (.5% in Component Part) Dodecamethylcyclohexasiloxane (D6) (.5% in Component Part)



Decamethylcyclopentasiloxane (D5) (.5% in Component Part)

**Article Safe Usage Statements:**  
Wash thoroughly after handling. Recycle if possible and dispose of the article by following all applicable governmental regulations relevant to your geographic location.







Halogen Content	Low Bromine/Chlorine - Br and Cl < 900 ppm per homogenous material. Also BFR /CFR/PVC Free
-----------------	--

Solder Process Capability	Not reviewed for solder process capability
---------------------------	--

Product Compliance Disclaimer

This information is provided based on reasonable inquiry of our suppliers and represents our current actual knowledge based on the information they provided. This information is subject to change. The part numbers that TE has identified as EU RoHS compliant have a maximum concentration of 0.1% by weight in homogenous materials for lead, hexavalent chromium, mercury, PBB, PBDE, DBP, BBP, DEHP, DIBP, and 0.01% for cadmium, or qualify for an exemption to these limits as defined in the Annexes of Directive 2011/65/EU (RoHS2). Finished electrical and electronic equipment products will be CE marked as required by Directive 2011/65/EU. Components may not be CE marked. Additionally, the part numbers that TE has identified as EU ELV compliant have a maximum concentration of 0.1% by weight in homogenous materials for lead, hexavalent chromium, and mercury, and 0.01% for cadmium, or qualify for an exemption to these limits as defined in the Annexes of Directive 2000/53/EC (ELV). Regarding the REACH Regulation, the information TE provides on SVHC in articles for this part number is based on the latest European Chemicals Agency (ECHA) 'Guidance on requirements for substances in articles' posted at this URL: <https://echa.europa.eu/guidance-documents/guidance-on-reach>

### Compatible Parts

 <p>TE Part # 2305570-1 Strip Terminal Cutter-Side Feed-No Crimp</p>	 <p>TE Part # CAT-T4827-T273 TIMER, RECEPTACLE AND TAB</p>	 <p>TE Part # CAT-M8793-T273 MQS, RECEPTACLE AND TAB</p>	 <p>TE Part # 2151493-1 OCEAN_2.0_APPLICATOR-S-055F072O</p>
 <p>TE Part # 2151541-1 OCEAN_2.0_APPLICATOR-S-050F072O</p>	 <p>TE Part # 2151620-1 OCEAN_2.0_Applicator-S-100F155O</p>	 <p>TE Part # 2151634-1 OCEAN-2.0-APPLICATOR-S-120F160OV</p>	

### Customers Also Bought



## Documents

### Product Drawings

[HEADER ASSY, Ag SHIELD, KEY B, HVA280-2P](#)

English

### CAD Files

[3D PDF](#)

3D

Customer View Model

[ENG\\_CVM\\_CVM\\_1-2103124-2\\_B.2d\\_dxf.zip](#)

English

Customer View Model

[ENG\\_CVM\\_CVM\\_1-2103124-2\\_B.3d\\_igs.zip](#)

English

Customer View Model

[ENG\\_CVM\\_CVM\\_1-2103124-2\\_B.3d\\_stp.zip](#)

English

By downloading the CAD file I accept and agree to the [Terms and Conditions](#) of use.

### Instruction Sheets



[Instruction Sheet \(U.S.\)](#)

English