

REVISIONS

P	LTR	DESCRIPTION	DATE	DWN	APVD
DI		REVISED (ECR-23-171026)	31MAR2023	CI	KT

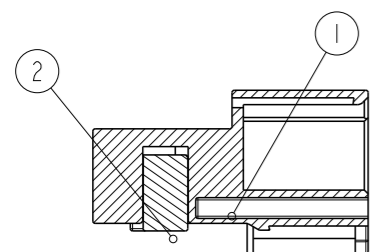

SECTION A - A

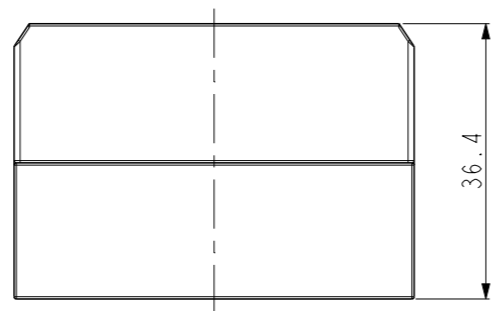
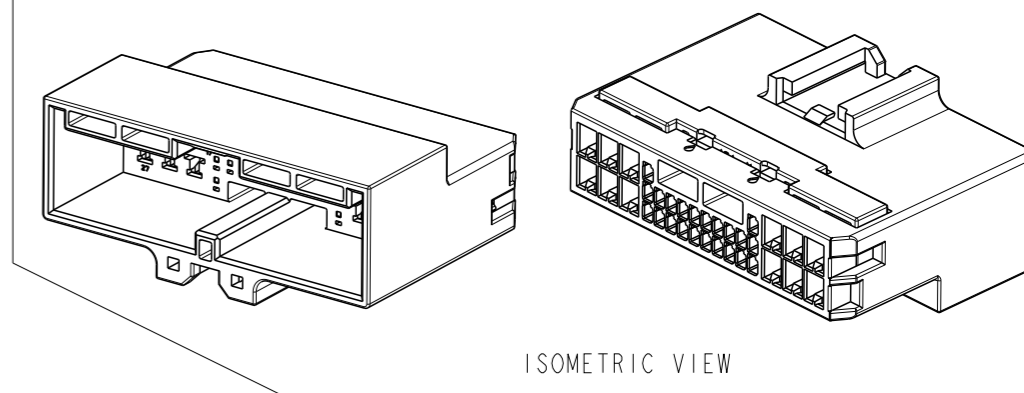
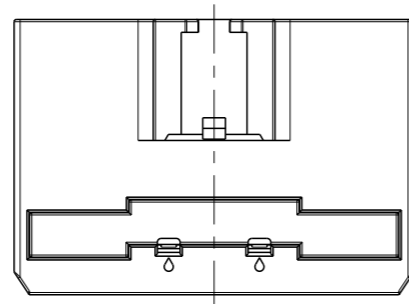
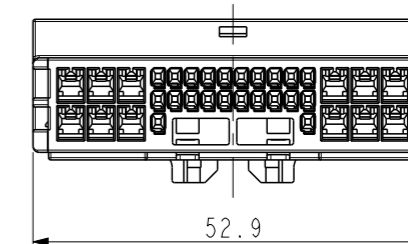
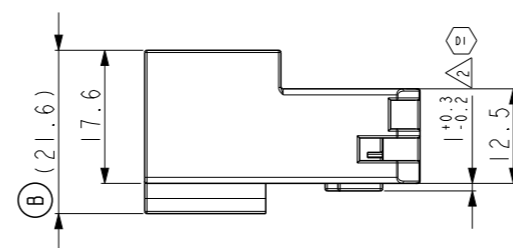
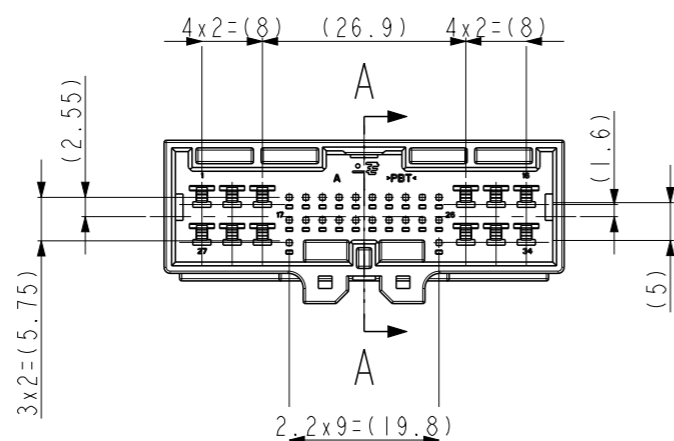

<TABLE 1>

TYPE	FINISH	P/N	WIRE RANGE (mm ²)
.025	PRE-TIN	2005098-1	0.22
	GOLD	2005154-1	0.37~0.56
.090	PRE-TIN	1897752-1	0.22~0.56
		368088-1	0.3~0.5
	GOLD	368087-1	0.85~1.25
		368086-1	2.0~2.5
		1-368088-1	0.3~0.5

NOTE
 1. GENERAL TOLERANCE: ±0.3, ±3°
 2. CONDITION OF DELIVERY
 DBL IN 1st LOCKING POSITION
 3. APPLICABLE PLUG ASS'Y P/N: x-2005431-x
 4. APPLICABLE TAB CONTACT P/N: <TABLE 1>

NO	FINISH/COLOR	MATERIAL	DESCRIPTION	Q'TY
2	WHITE	PBT	CAP DBL HSG	1
1	RED	PBT	CAP HSG	1
	BROWN	PBT	CAP HSG	1
	WHITE	PBT	CAP HSG	1

ASS'Y P/N	DESCRIPTION
2005434-6	HYB 34P CAP ASS'Y
2005434-4	HYB 34P CAP ASS'Y
2005434-1	HYB 34P CAP ASS'Y

THIS DRAWING IS A CONTROLLED DOCUMENT.

DIMENSIONS: mm	TOLERANCES UNLESS OTHERWISE SPECIFIED: 0 PLC ± 1 PLC ± 2 PLC ± 3 PLC ± 4 PLC ± ANGLES ± FINISH ±
MATERIAL SEE TABLE	

DWN CH PARK	NAME 025/090 HYBRID 34P CAP ASS'Y
CHK JW JUNG	
APVD HG CHO	
PRODUCT SPEC	
APPLICATION SPEC	SIZE A3
WEIGHT	CAGE CODE 00779
CUSTOMER DRAWING	DRAWING NO C-2005434

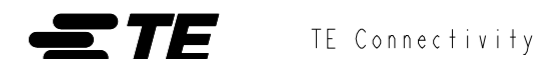

RESTRICTED TO	SCALE 1:1	SHEET 1 OF 1	REV DI
---------------	--------------	-----------------	-----------