

CLIFF

5 PIN XLR CONNECTORS

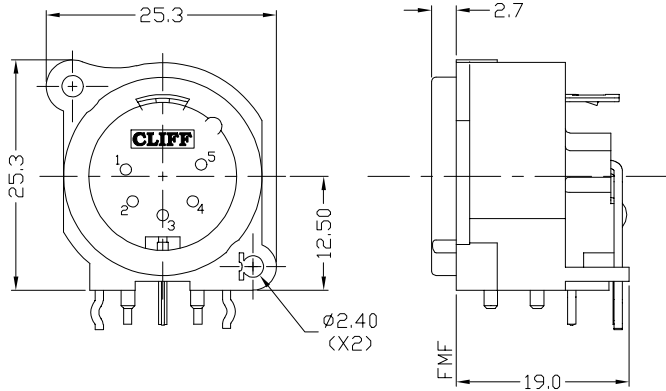

CP300255 - 5XNACM/PC90
Male 5 Pin 90 deg. PCB mount.



PCB LAYOUT (COMPONENT SIDE)

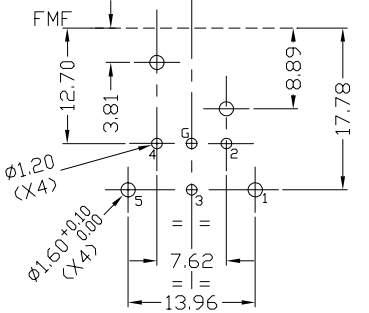

PANEL CUTOUT (COMPONENT SIDE)

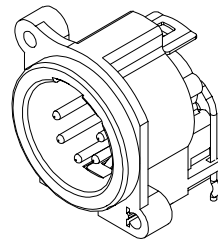
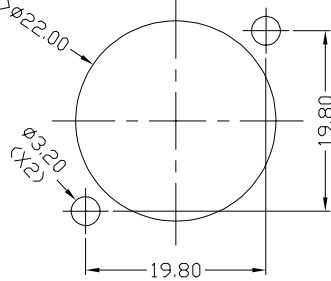

MINIMUM ASSEMBLY DISTANCE

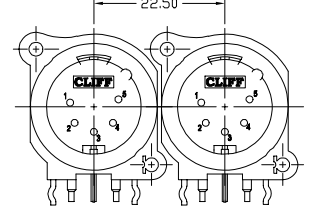

CP300405 - 5XNACF/PC90L
Female 5 Pin 90 deg. PCB mount with latch.

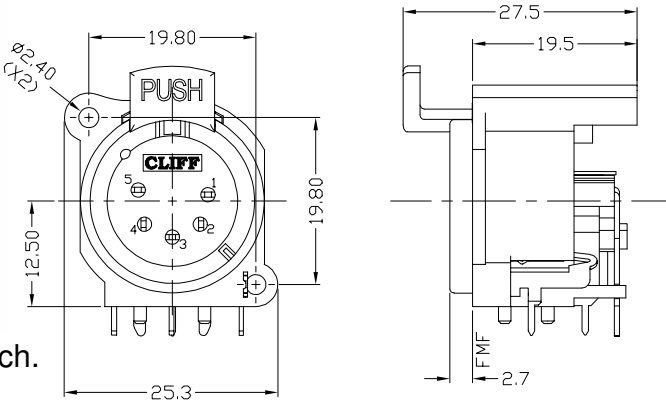

PCB LAYOUT (COMPONENT SIDE)

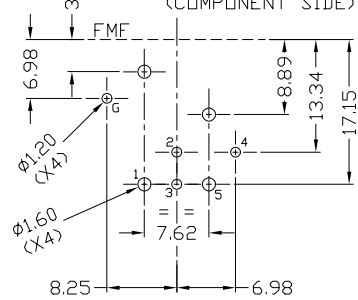

PANEL CUTOUT (COMPONENT SIDE)

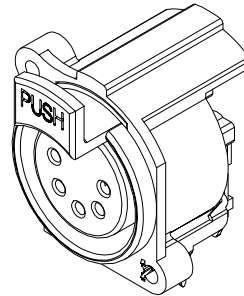
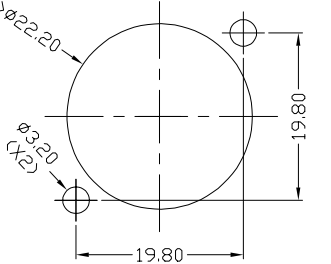

MINIMUM ASSEMBLY DISTANCE

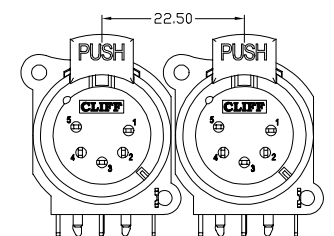

CLIFF

5 PIN XLR CONNECTORS

Main Features

- Space saving design.
- Horizontal PCB mounting.
- Tough plastic shell, reliable long life construction.
- Gold plated contacts.
- Self tap screw fixings to chassis.
- Push latch release mechanism.
- Material rated UL94HB

Electrical Specification

Current Rating:	5 pin 3A. max.
Rated Voltage:	50V AC max.
Contact Resistance New:	<10m Ω
Contact Resistance after 1000 insertions:	<15m Ω
Dielectric Withstand:	1500V DC
Insulation Resistance:	Greater than 10 ⁹ Ω
Capacitance between contacts:	7pf

Mechanical Specification

Insertion Life:	>1000 insertions
Insertion / Withdraw force:	30N / 10N

For further information, contact sales@cliffuk.co.uk

Cliff Electronic Components Limited,
76 Holmethorpe Avenue, Holmethorpe Ind. Estate,
Redhill, Surrey RH1 2PF U.K.
Tel: +44 (0)1737 771375 Fax: +44 (0)1737 766012



Visit us online at:

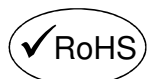

www.cliffuk.co.uk