

ON Semiconductor

Is Now

onsemi™

To learn more about onsemi™, please visit our website at
www.onsemi.com

onsemi and **onsemi** and other names, marks, and brands are registered and/or common law trademarks of Semiconductor Components Industries, LLC dba "**onsemi**" or its affiliates and/or subsidiaries in the United States and/or other countries. **onsemi** owns the rights to a number of patents, trademarks, copyrights, trade secrets, and other intellectual property. A listing of **onsemi** product/patent coverage may be accessed at www.onsemi.com/site/pdf/Patent-Marking.pdf. **onsemi** reserves the right to make changes at any time to any products or information herein, without notice. The information herein is provided "as-is" and **onsemi** makes no warranty, representation or guarantee regarding the accuracy of the information, product features, availability, functionality, or suitability of its products for any particular purpose, nor does **onsemi** assume any liability arising out of the application or use of any product or circuit, and specifically disclaims any and all liability, including without limitation special, consequential or incidental damages. Buyer is responsible for its products and applications using **onsemi** products, including compliance with all laws, regulations and safety requirements or standards, regardless of any support or applications information provided by **onsemi**. "Typical" parameters which may be provided in **onsemi** data sheets and/or specifications can and do vary in different applications and actual performance may vary over time. All operating parameters, including "Typicals" must be validated for each customer application by customer's technical experts. **onsemi** does not convey any license under any of its intellectual property rights nor the rights of others. **onsemi** products are not designed, intended, or authorized for use as a critical component in life support systems or any FDA Class 3 medical devices or medical devices with a same or similar classification in a foreign jurisdiction or any devices intended for implantation in the human body. Should Buyer purchase or use **onsemi** products for any such unintended or unauthorized application, Buyer shall indemnify and hold **onsemi** and its officers, employees, subsidiaries, affiliates, and distributors harmless against all claims, costs, damages, and expenses, and reasonable attorney fees arising out of, directly or indirectly, any claim of personal injury or death associated with such unintended or unauthorized use, even if such claim alleges that **onsemi** was negligent regarding the design or manufacture of the part. **onsemi** is an Equal Opportunity/Affirmative Action Employer. This literature is subject to all applicable copyright laws and is not for resale in any manner. Other names and brands may be claimed as the property of others.

Schottky Barrier Rectifier Trench-based, High Performance

NRTS30120MFS

This Trench Schottky rectifier is high performance device in SO-8 FL package. The lower forward voltage, less leakage current, and small junction capacitance are suitable to high switching frequency high density DC to DC conversion application. Offering higher avalanche energy capability for Oring or reverse protection application. The SO-8 FL package provides an excellent thermal performance, less land area of board space, and low profile.

Features

- Lower Forward Voltage Drop
- Less Leakage Current in High Temperature
- Small Junction Capacitance for High Switching Frequency
- Higher Avalanche Energy Capability
- 175°C Operating Junction Temperature
- Good Alternative Solution of SMC and DPAK Package
- Small Footprint – Land Area: 31.2 mm²
- Low Profile – Maximum Height of 1.1 mm
- These Devices are Pb-Free, Halogen Free/BFR Free and are RoHS Compliant

Mechanical Characteristics:

- Case: Molded Epoxy
- Epoxy Meets UL 94 V-0 @ 0.125 in
- Weight: 95 mg (Approximately)
- Lead and Mounting Surface Temperature for Soldering Purposes: 260°C Maximum for 10 Seconds
- MSL 1

Applications

- High Switching Frequency DC/DC Converter
- 2nd Rectifier
- Freewheeling Diode used with Inductive Load
- Oring / Reverse Protection



ON Semiconductor®

www.onsemi.com

TRENCH SCHOTTKY RECTIFIER 30 AMPERES 120 VOLTS

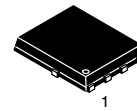

SO-8 FLAT LEAD
CASE 488AA
STYLE 2

MARKING DIAGRAM

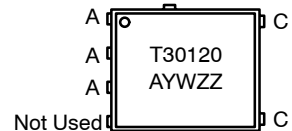

T30120 = Specific Device Code
A = Assembly Location
Y = Year
W = Work Week
ZZ = Lot Traceability

ORDERING INFORMATION

Device	Package	Shipping†
NRTS30120MFST3G	SO-8 FL (Pb-Free)	5000 / Tape & Reel

†For information on tape and reel specifications, including part orientation and tape sizes, please refer to our Tape and Reel Packaging Specification Brochure, BRD8011/D.

NRTS30120MFS

MAXIMUM RATINGS

Rating		Symbol	Value	Unit
Peak Repetitive Reverse Voltage Working Peak Reverse Voltage DC Blocking Voltage		V_{RRM} V_{RWM} V_R	120	V
Continuous Forward Current ($T_C = 162^\circ\text{C}$, DC)		$I_{F(DC)}$	30	A
Peak Repetitive Forward Current ($T_C = 159^\circ\text{C}$, Square Wave, Duty = 0.5)		I_{FRM}	60	A
Non-Repetitive Peak Surge Current	Sinusoidal Halfwave, 8.3 ms	I_{FSM}	300	A
	Square wave, 1 ms		370	
	Square wave, 100 μs		650	
Non-Repetitive Avalanche Energy ($T_J = 25^\circ\text{C}$)		E_{AS}	350	mJ
Storage Temperature Range		T_{stg}	-65 to +175	$^\circ\text{C}$
Operating Junction Temperature Range (Note 1)		T_J	-55 to +175	$^\circ\text{C}$
ESD Rating (Human Body Model)			38	
ESD Rating (Machine Model)			M4	

Stresses exceeding those listed in the Maximum Ratings table may damage the device. If any of these limits are exceeded, device functionality should not be assumed, damage may occur and reliability may be affected.

1. The heat generated must be less than the thermal conductivity from Junction-to-Ambient $dP_D/dT_J < 1/R_{\theta JA}$

THERMAL CHARACTERISTICS

Characteristic	Symbol	Max	Unit
Thermal Resistance, Junction-to-Ambient (Note 2)	$R_{\theta JA}$	56	$^\circ\text{C}/\text{W}$
Thermal Resistance, Junction-to-Case Bottom (Note 2)	$R_{\theta JCB}$	0.71	$^\circ\text{C}/\text{W}$
Thermal Characterization, Junction-to-Case Top (Note 2)	ψ_{JCT}	3.8	$^\circ\text{C}/\text{W}$
Thermal Characterization, Junction-to-Lead of Cathode (Note 2)	ψ_{JLC}	1.6	$^\circ\text{C}/\text{W}$

2. Assume 600 mm², 1 oz. copper bond pad on a FR4 board.

ELECTRICAL CHARACTERISTICS

Characteristic	Symbol	Typ	Max	Unit
Instantaneous Forward Voltage ($I_F = 15\text{ A}$, $T_J = 25^\circ\text{C}$) ($I_F = 15\text{ A}$, $T_J = 125^\circ\text{C}$) ($I_F = 30\text{ A}$, $T_J = 25^\circ\text{C}$) ($I_F = 30\text{ A}$, $T_J = 125^\circ\text{C}$)	V_F	0.65	-	V
		0.58	-	
		0.85	0.95	
		0.67	0.73	
Instantaneous Reverse Current ($V_R = \text{Rated DC Voltage}$, $T_J = 25^\circ\text{C}$) ($V_R = \text{Rated DC Voltage}$, $T_J = 125^\circ\text{C}$)	I_R	22	150	μA
		14	40	mA
Junction Capacitance ($V_R = 1\text{ V}$, $T_J = 25^\circ\text{C}$, $f = 1\text{ MHz}$)	C_J	1470	-	pF

Product parametric performance is indicated in the Electrical Characteristics for the listed test conditions, unless otherwise noted. Product performance may not be indicated by the Electrical Characteristics if operated under different conditions.

3. Pulse Test: Pulse Width = 300 μs , Duty Cycle $\leq 2.0\%$.

TYPICAL CHARACTERISTICS

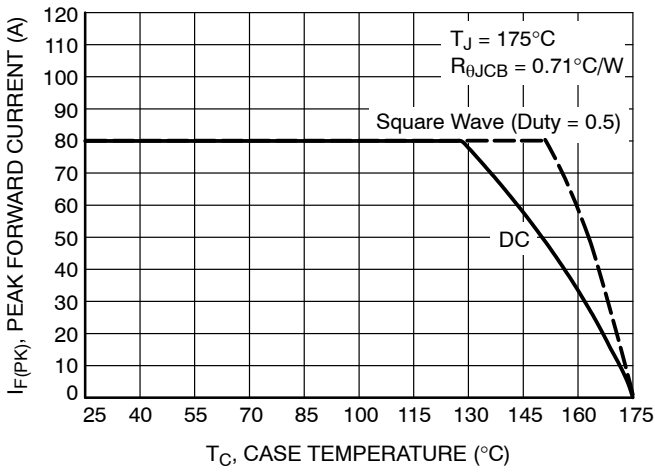

Figure 1. Forward Current Derating of Case Temperature

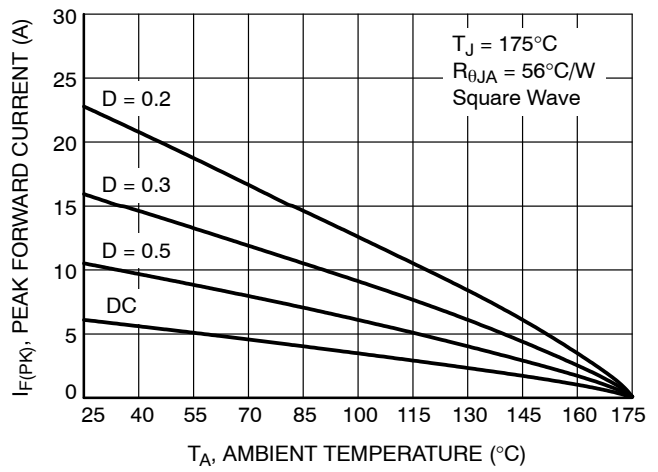

Figure 2. Forward Current Derating of Ambient Temperature

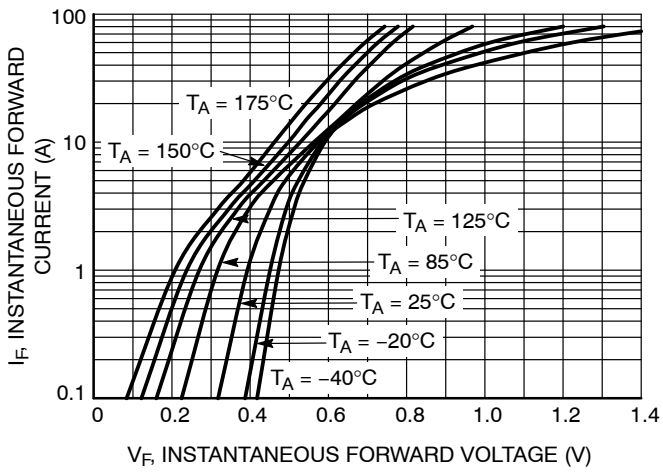

Figure 3. Typical Forward Characteristics

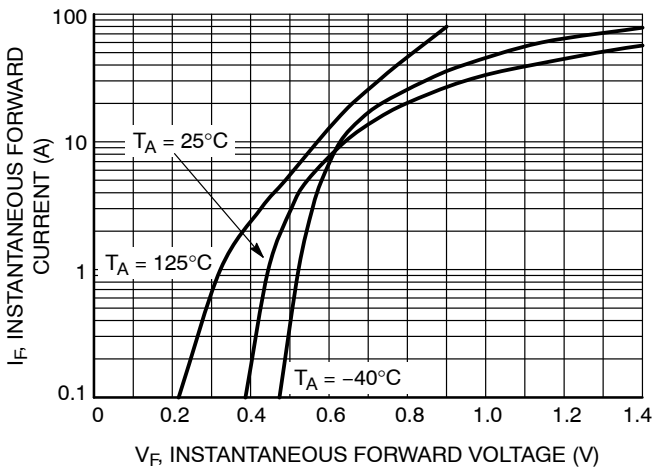

Figure 4. Maximum Forward Characteristics

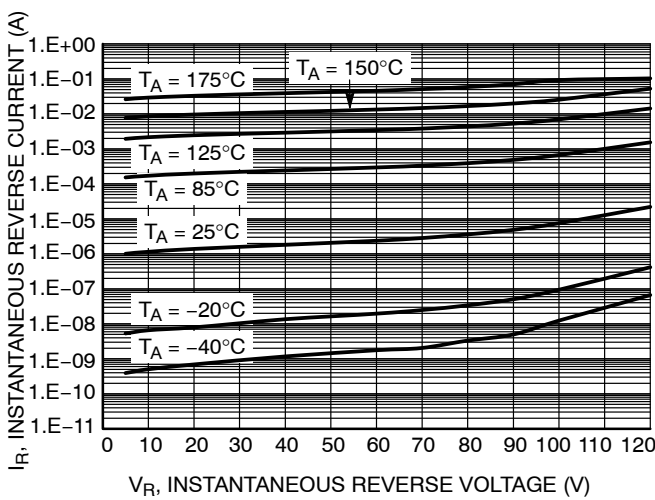

Figure 5. Typical Reverse Characteristics

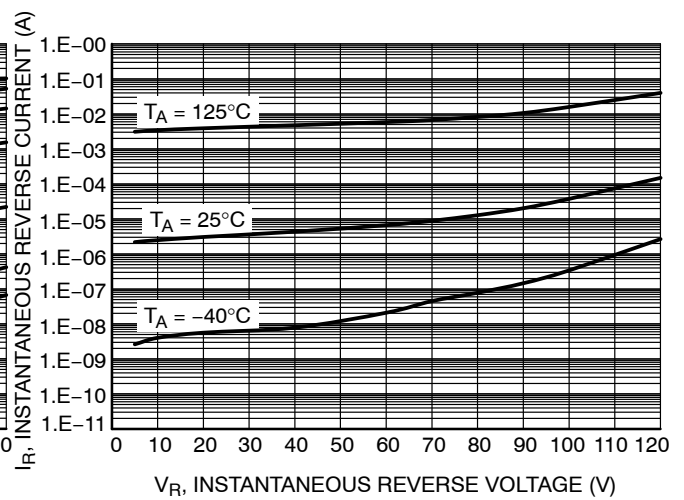

Figure 6. Maximum Reverse Characteristics

NRTS30120MFS

TYPICAL CHARACTERISTICS

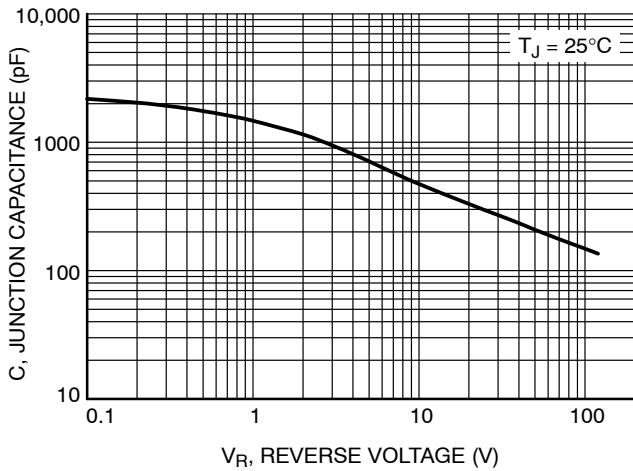

Figure 7. Typical Junction Capacitance

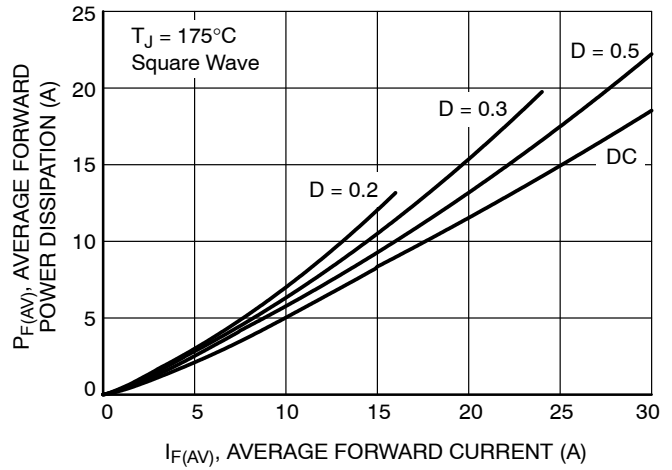

Figure 8. Average Forward Power Dissipation

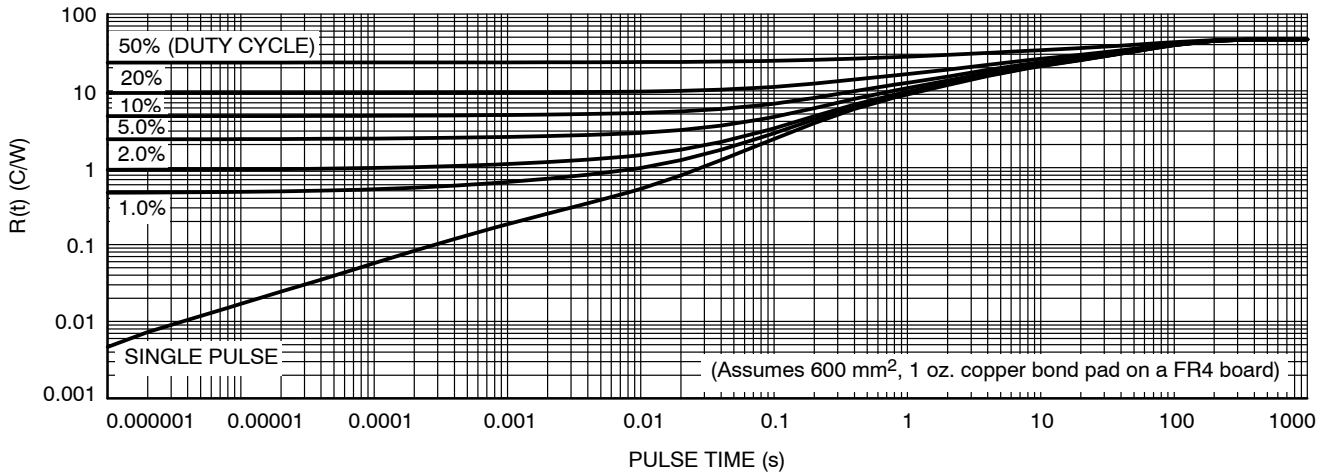

Figure 9. Typical Thermal Characteristics, Junction-to-Ambient

NRTS30120MFS

PACKAGE DIMENSIONS

DFN5 5x6, 1.27P
(SO-8FL)
CASE 488AA
ISSUE N

NOTES:

1. DIMENSIONING AND TOLERANCING PER ASME Y14.5M, 1994.
2. CONTROLLING DIMENSION: MILLIMETER.
3. DIMENSION D1 AND E1 DO NOT INCLUDE MOLD FLASH PROTRUSIONS OR GATE BURRS.

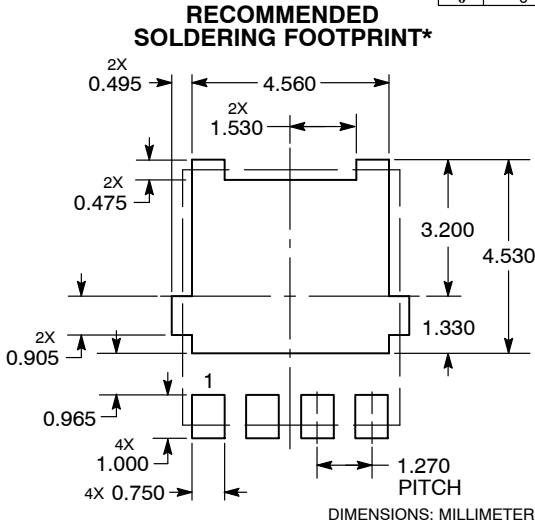
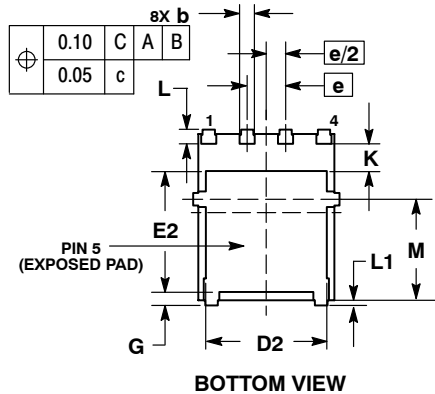
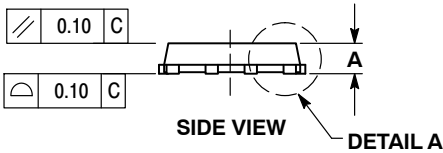
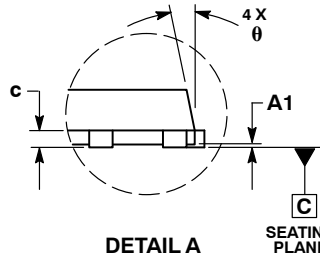
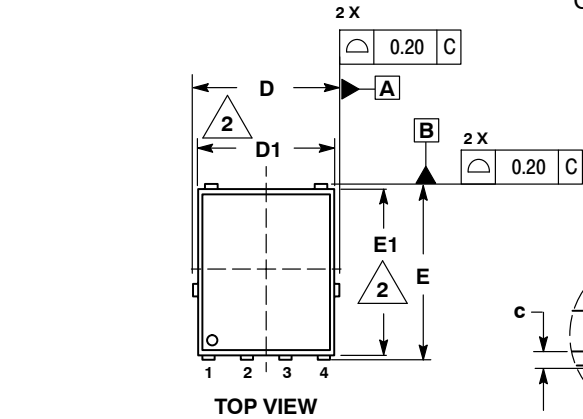

- STYLE 1:
 1. SOURCE
 2. SOURCE
 3. SOURCE
 4. GATE
 5. DRAIN

DIM	MILLIMETERS		
	MIN	NOM	MAX
A	0.90	1.00	1.10
A1	0.00	---	0.05
b	0.33	0.41	0.51
c	0.23	0.28	0.33
D	5.00	5.15	5.30
D1	4.70	4.90	5.10
D2	3.80	4.00	4.20
E	6.00	6.15	6.30
E1	5.70	5.90	6.10
E2	3.45	3.65	3.85
e	1.27 BSC		
G	0.51	0.575	0.71
K	1.20	1.35	1.50
L	0.51	0.575	0.71
L1	0.125 REF		
M	3.00	3.40	3.80
θ	0°	---	12°

*For additional information on our Pb-Free strategy and soldering details, please download the ON Semiconductor Soldering and Mounting Techniques Reference Manual, SOLDERRM/D.

ON Semiconductor and are trademarks of Semiconductor Components Industries, LLC dba ON Semiconductor or its subsidiaries in the United States and/or other countries. ON Semiconductor owns the rights to a number of patents, trademarks, copyrights, trade secrets, and other intellectual property. A listing of ON Semiconductor's product/patent coverage may be accessed at www.onsemi.com/site/pdf/Patent-Marking.pdf. ON Semiconductor reserves the right to make changes without further notice to any products herein. ON Semiconductor makes no warranty, representation or guarantee regarding the suitability of its products for any particular purpose, nor does ON Semiconductor assume any liability arising out of the application or use of any product or circuit, and specifically disclaims any and all liability, including without limitation special, consequential or incidental damages. Buyer is responsible for its products and applications using ON Semiconductor products, including compliance with all laws, regulations and safety requirements or standards, regardless of any support or applications information provided by ON Semiconductor. "Typical" parameters which may be provided in ON Semiconductor data sheets and/or specifications can and do vary in different applications and actual performance may vary over time. All operating parameters, including "Typicals" must be validated for each customer application by customer's technical experts. ON Semiconductor does not convey any license under its patent rights nor the rights of others. ON Semiconductor products are not designed, intended, or authorized for use as a critical component in life support systems or any FDA Class 3 medical devices or medical devices with a same or similar classification in a foreign jurisdiction or any devices intended for implantation in the human body. Should Buyer purchase or use ON Semiconductor products for any such unintended or unauthorized application, Buyer shall indemnify and hold ON Semiconductor and its officers, employees, subsidiaries, affiliates, and distributors harmless against all claims, costs, damages, and expenses, and reasonable attorney fees arising out of, directly or indirectly, any claim of personal injury or death associated with such unintended or unauthorized use, even if such claim alleges that ON Semiconductor was negligent regarding the design or manufacture of the part. ON Semiconductor is an Equal Opportunity/Affirmative Action Employer. This literature is subject to all applicable copyright laws and is not for resale in any manner.

PUBLICATION ORDERING INFORMATION

LITERATURE FULFILLMENT:
 Email Requests to: orderlit@onsemi.com

TECHNICAL SUPPORT
 North American Technical Support:
 Voice Mail: 1 800-282-9855 Toll Free USA/Canada
 Phone: 011 421 33 790 2910

Europe, Middle East and Africa Technical Support:
 Phone: 00421 33 790 2910
 For additional information, please contact your local Sales Representative