

# FEW SERIES

20~30W WIDE INPUT RANGE

# DANUBE

## FEATURES

- 20~30W DIL PACKAGE
- INDUSTRY STANDARD PACKAGE
- 9-18V,18-36V,36-75V,9-36V,18-75V WIDE INPUT RANGE
- REGULATED OUTPUT
- INPUT UVLO & OVLO
- HIGH EFFICIENCY
- UL 94V-0 PACKAGE MATERIAL
- CUSTOM SOLUTIONS AVAILABLE
- 3 YEARS WARRANTY



## OUTPUT SPECIFICATIONS

Voltage Set-point Accuracy	+/-2% max.
Temperature Coefficient	+/-0.05%/°C
Ripple & Noise(20MHz BW) <sup>1</sup>	150mVp-p max.
Line Regulation <sup>2</sup>	+/-0.3% max.
Load Regulation <sup>3</sup>	+/-0.5% max.
Minimum Load <sup>4</sup>	10% of Full Load
Short Circuit Protection	Continuous
Short Circuit Restart	Automatic
Over Load Protection	130%~180%
Transient Response <sup>6</sup>	500uS max.
External Trim Adj. Range	Vout:5V +/-10%
External Trim Adj. Range	Vout:12V,15V -20%~+10%

## ENVIRONMENTAL SPECIFICATIONS

Operating Temperature (20W)	-40°C to +75°C
Operating Temperature (30W)	-40°C to +55°C
Case Temperature	+100°C max.
Storage Temperature	-55°C to +125°C
Humidity	95% max.
Cooling	Free-Air Convection

## INPUT SPECIFICATIONS

Input Voltage Range	2:1 or 4:1 Input Range
Input Filter	Pi Network
Protection	Fuse Recommended
OVLO(Over Voltage Lockout)	See Page 6
UVLO(Under Voltage Lockout)	See Page 6
OVLO & UVLO Circuit Restart	Automatic

## GENERAL SPECIFICATIONS

Efficiency	88% typ.
Isolation Voltage <sup>5</sup>	1500VDC min.
Isolation Resistance	10 <sup>9</sup> ohms min.
Isolation Capacitance	3000pF max.
Switching Frequency	300 KHz typ.
MTBF <sup>7</sup>	>300,000 Hours
Weight	31.2g typ.
Case Material	Six-Side Shielded Case
Case Size	50.8mm*25.4mm*11.2mm
Radiated Emissions	EN55022 Class A

ALL SPECIFICATIONS TYPICAL AT NOMINAL LINE, FULL LOAD, AND 25°C UNLESS OTHERWISE NOTED.

<sup>1</sup> Measured with 1uF ceramic capacitor connect to the output pins.

<sup>2</sup> High Line to Low Line.

<sup>3</sup> Load Regulation is for output load current change from 10% to 100%.

<sup>4</sup> FEWS-XXXXA20T Minimum load 20% of full load.

<sup>5</sup> For 10 seconds.

<sup>6</sup> 25% Step Load Change.

<sup>7</sup> MIL-HDBK-217F @25°C, Ground Benign.

● **SELECTION GUIDE**  
**2:1 20W OUTPUT**

MODEL NUMBER	INPUT VOLTAGE (VDC)	OUTPUT VOLTAGE (VDC)	OUTPUT CURRENT (mA)	INPUT <sup>8</sup> CURRENT(mA)		EFF (%) <sup>9</sup>	CAPACITOR LOAD (Max)	PACKAGE
				FULL LOAD	NO LOAD			
FEWS-1203.3A20	9-18	3.3	5000	1617	65	85	1000uF	<b>A</b>
FEWS-1205A20	9-18	5	4000	1893	65	88	1000uF	
FEWS-1212A20	9-18	12	1666	1893	20	88	220uF	
FEWS-1215A20	9-18	15	1333	1872	20	89	100uF	
FEWD-1212A20	9-18	+/-12	+/-833	1893	20	88	+/-100uF	
FEWD-1215A20	9-18	+/-15	+/-667	1872	20	89	+/-47uF	
FEWS-2403.3A20	18-36	3.3	5000	809	45	85	1000uF	
FEWS-2405A20	18-36	5	4000	947	45	88	1000uF	
FEWS-2412A20	18-36	12	1666	936	20	89	220uF	
FEWS-2415A20	18-36	15	1333	926	20	90	100uF	
FEWD-2412A20	18-36	+/-12	+/-833	936	20	89	+/-100uF	
FEWD-2415A20	18-36	+/-15	+/-667	926	20	89	+/-47uF	
FEWS-4803.3A20	36-75	3.3	5000	404	40	85	1000uF	
FEWS-4805A20	36-75	5	4000	473	40	88	1000uF	
FEWS-4812A20	36-75	12	1666	473	10	88	220uF	
FEWS-4815A20	36-75	15	1333	468	10	89	100uF	
FEWD-4812A20	36-75	+/-12	+/-833	473	10	88	+/-100uF	
FEWD-4815A20	36-75	+/-15	+/-667	473	10	88	+/-47uF	

*Note: Other input to output voltages may be available. Please contact factory.*

<sup>8</sup> NOMINAL INPUT VOLTAGE.

<sup>9</sup> NOMINAL INPUT VOLTAGE, FULL LOAD.

● **SELECTION GUIDE**  
**4:1 20W OUTPUT**

MODEL NUMBER	INPUT VOLTAGE (VDC)	OUTPUT VOLTAGE (VDC)	OUTPUT CURRENT (mA)	INPUT <sup>10</sup> CURRENT (mA)		EFF (%) <sup>11</sup>	CAPACITOR LOAD (Max)	PACKAGE
				FULL LOAD	NO LOAD			
				FEWS-1203.3A20T	9-36			
FEWS-1205A20T	9-36	5	4000	1915	80	87	1000uF	
FEWS-1212A20T	9-36	12	1666	1914	20	87	220uF	
FEWS-1215A20T	9-36	15	1333	1915	20	87	100uF	
FEWS-2403.3A20T	18-75	3.3	5000	808	60	85	1000uF	
FEWS-2405A20T	18-75	5	4000	957	60	87	1000uF	
FEWS-2412A20T	18-75	12	1666	957	20	87	220uF	
FEWS-2415A20T	18-75	15	1333	957	20	87	100uF	

*Note: Other input to output voltages may be available. Please contact factory.*

<sup>10</sup> NOMINAL INPUT VOLTAGE.

<sup>11</sup> NOMINAL INPUT VOLTAGE, FULL LOAD.

● **SELECTION GUIDE**  
**2:1 30W OUTPUT**

MODEL NUMBER	INPUT VOLTAGE (VDC)	OUTPUT VOLTAGE (VDC)	OUTPUT CURRENT (mA)	INPUT <sup>12</sup> CURRENT(mA)		EFF (%) <sup>13</sup>	CAPACITOR LOAD (Max)	PACKAGE
				FULL LOAD	NO LOAD			
FEWS-1203.3B30	9-18	3.3	7000	2292	180	85	1000uF	<b>B</b>
FEWS-1205B30	9-18	5	6000	2841	165	88	1000uF	
FEWS-1212B30	9-18	12	2500	2793	140	89.5	220uF	
FEWS-1215B30	9-18	15	2000	2793	120	89.5	100uF	
FEWS-2403.3B30	18-36	3.3	7000	1119	120	86	1000uF	
FEWS-2405B30	18-36	5	6000	1412	95	88.5	1000uF	
FEWS-2412B30	18-36	12	2500	1404	40	89	220uF	
FEWS-2415B30	18-36	15	2000	1389	40	90	100uF	
FEWS-4803.3B30	36-75	3.3	7000	566	85	85	1000uF	
FEWS-4805B30	36-75	5	6000	710	60	88	1000uF	
FEWS-4812B30	36-75	12	2500	702	55	89	220uF	
FEWS-4815B30	36-75	15	2000	694	30	90	100uF	

*Note: Other input to output voltages may be available. Please contact factory.*

<sup>12</sup> NOMINAL INPUT VOLTAGE.

<sup>13</sup> NOMINAL INPUT VOLTAGE, FULL LOAD.

## ● PART NUMBERS STRUCTURE

Model Name	Difference
FEWv-x1x2x3x4T-zzz	<p>FE=Series Name</p> <p>W=Wide Input Range</p> <p>v=Type of output voltage (S=Single output ; D=Dual output)</p> <p>x1=12V (9~18V ; 9~36V Input voltage)            24V (18~36V ; 18~75V Input voltage)            48V (36~75V Input voltage)</p> <p>x2=Output voltage(3.3V ; 5V ; 12V ; 15V)</p> <p>x3=Package(A ; B)</p> <p>x4=Power(20W ; 30W)</p> <p>T= 4:1 Input voltage</p> <p>zzz= 0~9 , A~Z or blank for market purpose.</p>

## ● MECHANICAL DIMENSIONS

### PACKAGE "A"

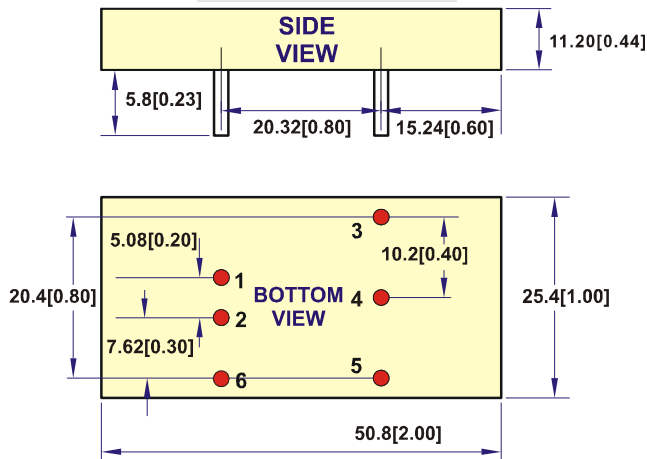

All dimensions are in millimeters [inches]

PIN	SINGLE	DUAL
1	+Vin	+Vin
2	-Vin	-Vin
3	+Vout	+Vout
4	Trim	Common
5	-Vout	-Vout
6	Remote On/Off	Remote On/Off

NOTE:

All dimensions are in millimeters [inches]

Pin Size is Tolerance 1.0Φ ±0.10mm

Tolerance .X or .XX= ±0.80mm

### PACKAGE "B"

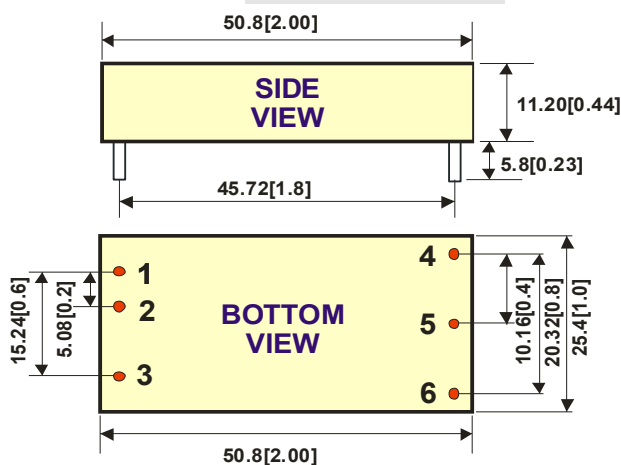

All dimensions are in millimeters [inches]

PIN	SINGLE
1	+Vin
2	-Vin
3	Remote On/Off
4	+Vout
5	-Vout
6	Trim

NOTE:

All dimensions are in millimeters [inches]

Pin Size is Tolerance 1.0Φ ±0.10mm

Tolerance .X or .XX= ±0.80mm

● **RECOMMENDED FOOTPRINT DETAILS**

**PACKAGE "A"**

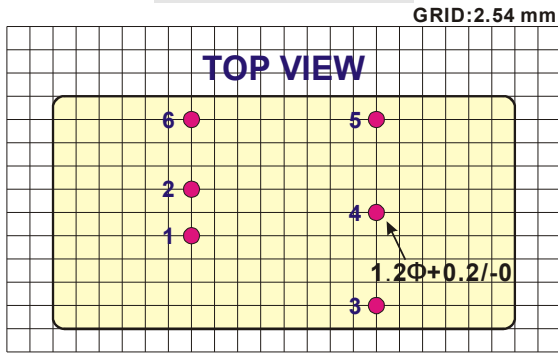

**PACKAGE "B"**

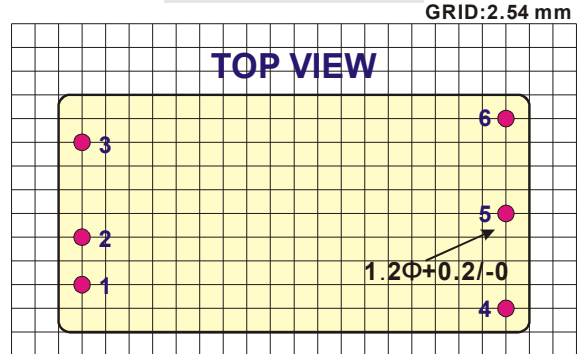

Remote On/Off Control			
Control Input	Package A : PIN6	Package B : PIN3	Control Common PIN2
Control Voltage			Converter Shutdown Idle Current 10mA
ON	>+2.5VDC or Open Circuit		CMOS or Open
OFF	<+0.8VDC or Jumper to PIN2		Collector TTL

● **INPUT OPERATING VOLTAGE**

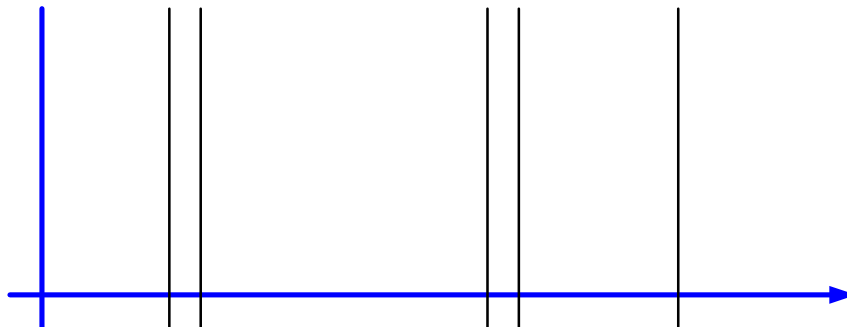

	A	B	C	D	E
FEW*-12*****	8V typ.	9V	18V	20V typ.	25V
FEWS-12*****T	8V typ.	9V	36V	40V typ.	50V
FEW*-24*****	16V typ.	18V	36V	40V typ.	50V
FEWS-24*****T	16V typ.	18V	75V	80V typ.	100V
FEW*-48*****	32V typ.	36V	75V	80V typ.	100V

## ● SIMPLIFIED SCHEMATIC

### SINGLE OUTPUT

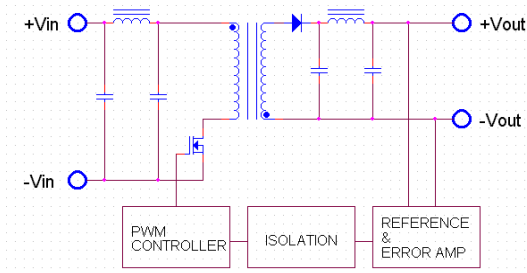

### DUAL OUTPUT

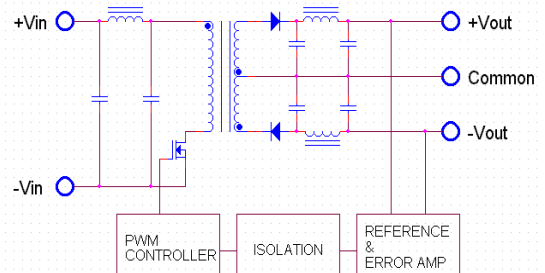

## ● TYPICAL APPLICATIONS

### SINGLE OUTPUT

#### FIXED VOLTAGE OUTPUT

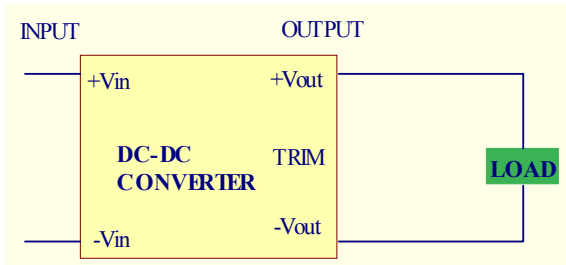

### DUAL OUTPUT

#### FIXED VOLTAGE OUTPUT

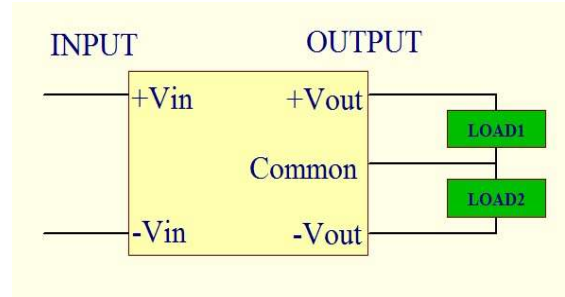

#### TRIM CONNECTIONS USING A TRIMPOT

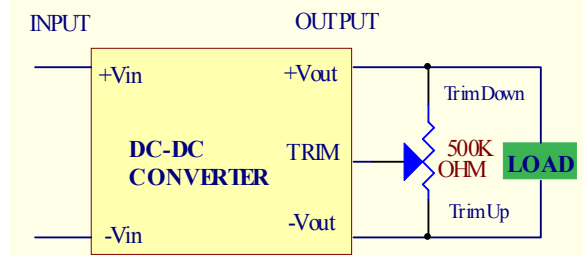

#### FIXED-VALUE TRIM DOWN RESISTOR

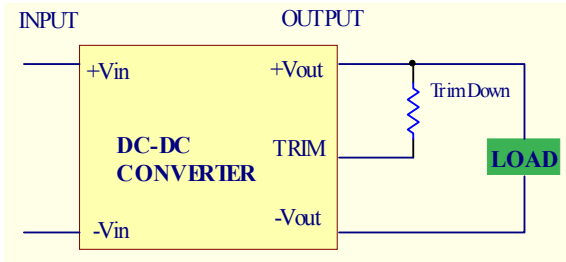

#### FIXED-VALUE TRIM UP RESISTOR

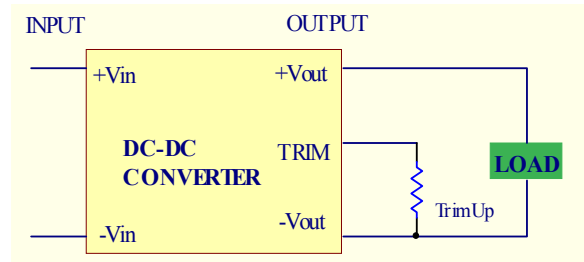

## ● TYPICAL PERFORMANCE CURVES

Specifications typical at  $T_a=25^\circ\text{C}$ , nominal input voltage, rated output current unless otherwise specified.

### OUTPUT LOAD VS EFFICIENCY

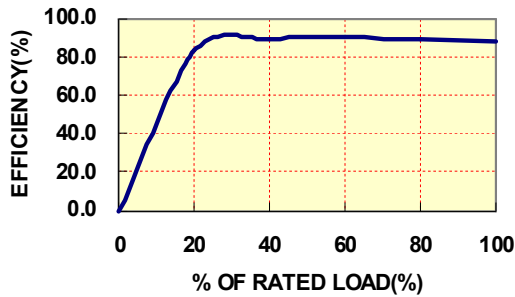

### TEMPERATURE DERATING

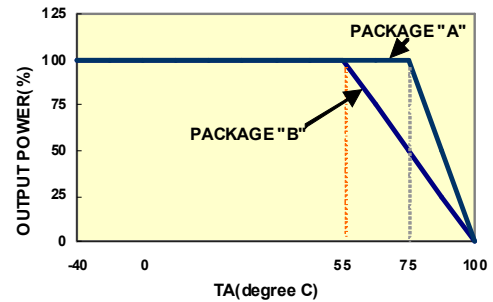

## ● RECOMMENDED FILTER FOR EN55022 CLASS B

The components used in the above figure, together with the manufacturer's part numbers for these components, are as follows:

	C1	C2	C3	C4	L1
<b>FEW*-12*****</b>	3.3uF/50V 1812 MLCC	3.3uF/50V 1812 MLCC	1000pF/2KV MLCC	1000pF/2KV MLCC	325uH Common Choke
<b>FEW*-24*****</b>	3.3uF/50V 1812 MLCC	N/A	1000pF/2KV MLCC	1000pF/2KV MLCC	325uH Common Choke
<b>FEW*-48*****</b>	1.5uF/100V 1812 MLCC	1.5uF/100V 1812 MLCC	1000pF/2KV MLCC	1000pF/2KV MLCC	325uH Common Choke

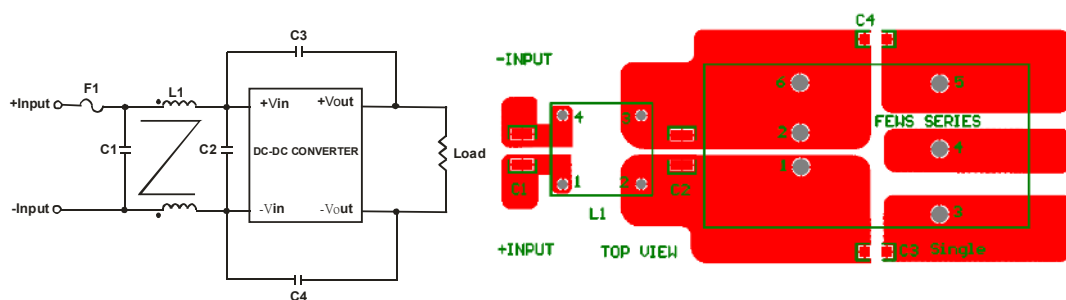

RECOMMENDED EN55022 CLASS B FILTER CIRCUIT LAYOUT



## ● INPUT FUSE SELECTION GUIDE

9-18V INPUT VOLTAGE(VDC)	18-36V INPUT VOLTAGE(VDC)	36-75V INPUT VOLTAGE(VDC)
5000mA Slow-Blow Type	3000mA Slow-Blow Type	1500mA Slow-Blow Type

**Note:** Certain applications may require the installation of external fuse in front of the input.

### FEW SERIES APPLICATION NOTES: EXTERNAL CAPACITANCE REQUIREMENTS:

No external capacitance is required for operation of the FEW series.

External output capacitance is not required for operation; however it is recommended that 10uF tantalum and 0.1uF ceramic capacitance be selected for reduced system noise.

We Can Offer EMC-Filter According To EN55011/22 Class B.

### Negative Outputs:

A negative output voltage may be obtained by connecting the +OUT to circuit ground and connecting -OUT as the negative output.

### Remote ON/OFF:

The remote ON/OFF pin may be left floating if this function is not use. It is recommended to drive this pin with an open collector arrangement or a relay contact. When the ON/OFF pin is pulled low with respect to the -VIN, the converter is placed in a low power drain state.

### Output TRIM:

The TRIM pin may be used to adjust the output +10% ~ -20% from the nominal setting .this function allows adjustment for voltage drops in the system wiring. If the TRIM function is not required the pin may be left floating.

## FOR MORE INFORMATION CALL:

**Danube Enterprise Co., Ltd.**

Tel: 886-7-3755165

Fax: 886-7-3755330

E-mail: [danube@ms10.hinet.net](mailto:danube@ms10.hinet.net)

Home Page

<http://www.danube.com.tw>