

THIS DRAWING IS UNPUBLISHED. RELEASED FOR PUBLICATION 09MAR, 2006.

© COPYRIGHT 2006 BY TYCO ELECTRONICS CORPORATION. ALL RIGHTS RESERVED.

LOC	DIST	REVISIONS					
E	B	P	LTR	DESCRIPTION	DATE	DWN	APVD
		A		FIRST ISSUE	22FEB06	MTN	FWK

NOTES:

- ELECTRICAL DATA: CONTACT RESISTANCE: 10 mOhm MAX
INSULATION RESISTANCE: 100 MOhm MIN at 500VDC
CURRENT RATING: 5 AMPS (FOR 3, 4 AND 5 POSITIONS) AND 2 AMPS (FOR 8 POSITION ONLY)
BREAKDOWN VOLTAGE: 500 VAC MIN PER MINUTE
- ENVIRONMENTAL: OPERATING TEMPERATURE: -25°C TO +90°C
SEALING REQUIREMENTS: IP67
- PROD SPEC: 108-3641
- PACKAGING: 107-3334
- FOR TECHNICAL DATA REFER TO YOUR LOCAL TYCO ELECTRONICS SALES OFFICE.
- ALL DIMENSIONS ARE NOMINAL FOR REFERENCE ONLY UNLESS OTHERWISE STATED.

ITEM	DESCRIPTION	MATERIAL	FINISH/COLOUR	QUANTITY / ITEM			
				-1	-2	-3	-4
1	CONNECTOR HOUSING	GF NYLON	BLACK	1	1	1	1
2	SOCKET CONTACT	BRASS	0.15µm GOLD OVER NICKEL	3	4	5	8
3	CONNECTOR BODY	BRASS	NICKEL PLATED	1	1	1	1
4	'O' RING	VITON	GREEN	1	1	1	1
5	'O' RING	EPDM	BLACK	1	1	1	1
6	SCREW NUT	BRASS	2.5µm NICKEL PLATED	1	1	1	1

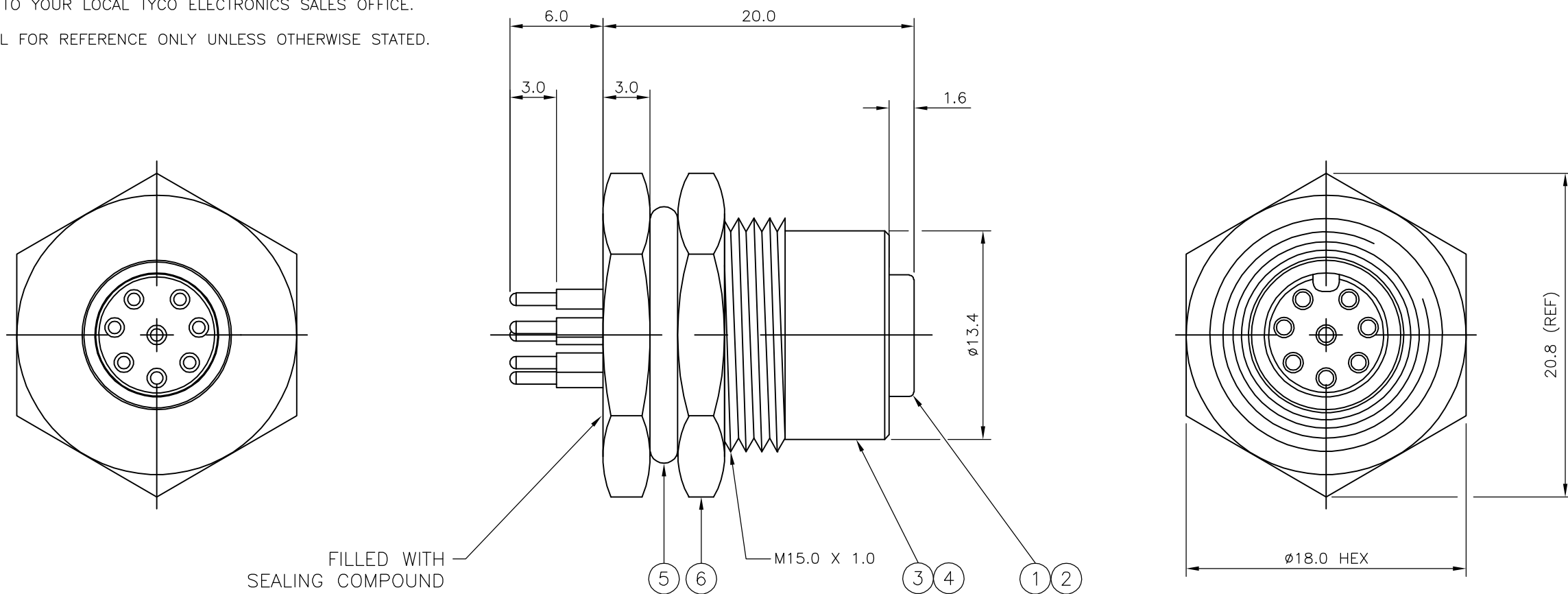

DESCRIPTION	NO. OF POS	PART NUMBER
M12 METAL FEMALE PANEL MOUNT CONNECTOR, PCB, STRAIGHT, FRONT (HEXAGONAL) MOUNTING	8	1838417-4
M12 METAL FEMALE PANEL MOUNT CONNECTOR, PCB, STRAIGHT, FRONT (HEXAGONAL) MOUNTING	5	1838417-3
M12 METAL FEMALE PANEL MOUNT CONNECTOR, PCB, STRAIGHT, FRONT (HEXAGONAL) MOUNTING	4	1838417-2
M12 METAL FEMALE PANEL MOUNT CONNECTOR, PCB, STRAIGHT, FRONT (HEXAGONAL) MOUNTING	3	1838417-1

THIS DRAWING IS A CONTROLLED DOCUMENT.		DWN A.Morey 09MAR06	Tyco Electronics Corporation Bideford, UK, EX39 4HE													
DIMENSIONS: mm		CHK F.Wheeler-King 12APR06														
TOLERANCES UNLESS OTHERWISE SPECIFIED:		APVD F.Wheeler-King 12APR06	NAME M12 METAL FEMALE PANEL MOUNT CONNECTOR, PCB, STRAIGHT, FRONT (HEXAGONAL) MOUNTING													
<table border="1"> <tr><td>0 PLC</td><td>± -</td></tr> <tr><td>1 PLC</td><td>± -</td></tr> <tr><td>2 PLC</td><td>± -</td></tr> <tr><td>3 PLC</td><td>± -</td></tr> <tr><td>4 PLC</td><td>± -</td></tr> <tr><td>ANGLES</td><td>± -</td></tr> </table>		0 PLC	± -	1 PLC	± -	2 PLC	± -	3 PLC	± -	4 PLC	± -	ANGLES	± -	PRODUCT SPEC -	SIZE A3	
0 PLC	± -															
1 PLC	± -															
2 PLC	± -															
3 PLC	± -															
4 PLC	± -															
ANGLES	± -															
MATERIAL -		FINISH -	CAGE CODE 00779	DRAWING NO 1838417												
CUSTOMER DRAWING			RESTRICTED TO -	SCALE NTS												
			SHEET 1	OF 2												
			REV A													

THIS DRAWING IS UNPUBLISHED. RELEASED FOR PUBLICATION 09MAR, 2006.
 © COPYRIGHT 2006 BY TYCO ELECTRONICS CORPORATION. ALL RIGHTS RESERVED.

LOC	DIST	REVISIONS					
E	B	P	LTR	DESCRIPTION	DATE	DWN	APVD
			-	SEE SHEET 1	-	-	-

1838417-1

1838417-2

1838417-3

1838417-4

PIN ASSIGNMENTS
FRONT VIEW

PIN ASSIGNMENTS
FRONT VIEW

PIN ASSIGNMENTS
FRONT VIEW

PIN ASSIGNMENTS
FRONT VIEW

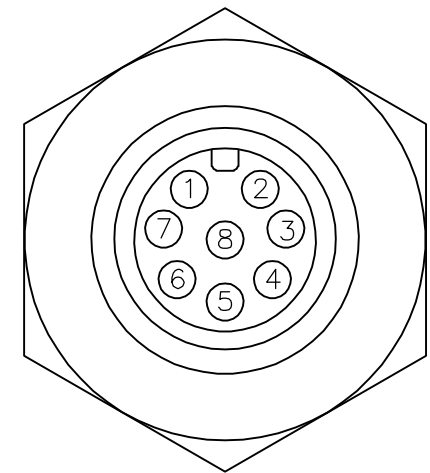
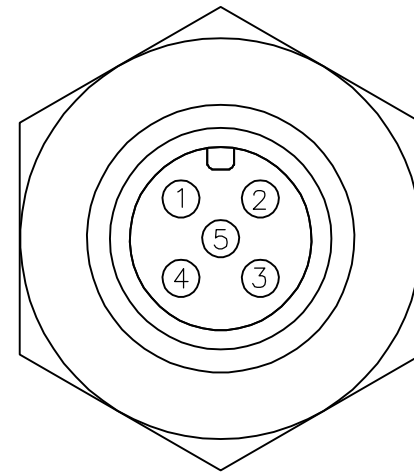
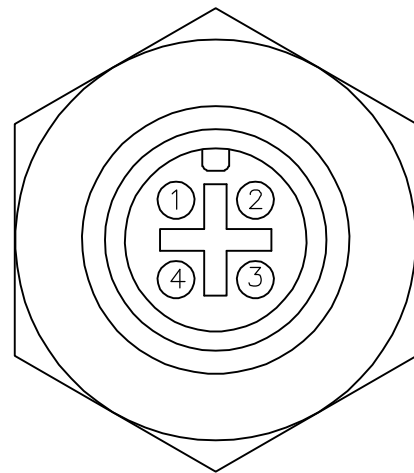
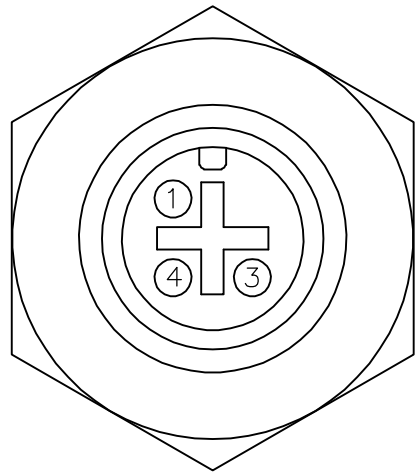

RECOMMENDED PANEL CUT-OUT
(MAX PANEL THICKNESS 3.9mm)

RECOMMENDED PANEL CUT-OUT
(MAX PANEL THICKNESS 3.9mm)

RECOMMENDED PANEL CUT-OUT
(MAX PANEL THICKNESS 3.9mm)

RECOMMENDED PANEL CUT-OUT
(MAX PANEL THICKNESS 3.9mm)

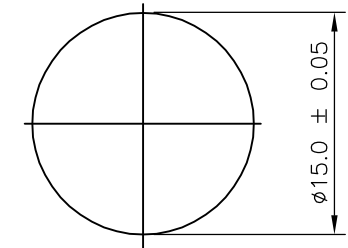
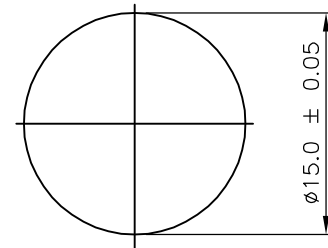
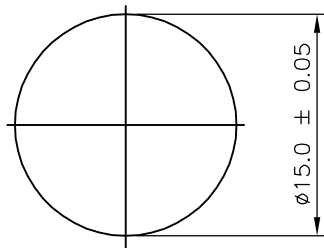
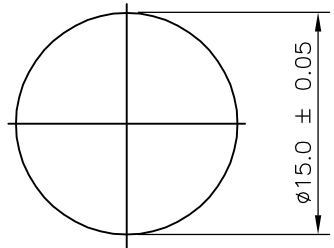

RECOMMENDED
PCB LAYOUT

RECOMMENDED
PCB LAYOUT

RECOMMENDED
PCB LAYOUT

RECOMMENDED
PCB LAYOUT

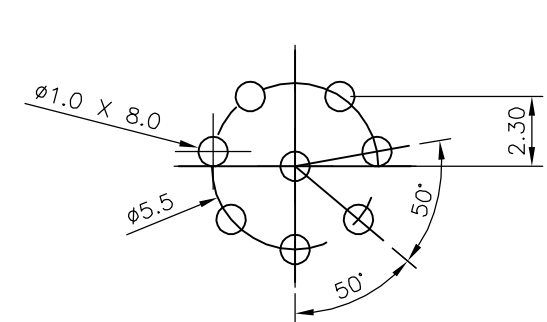
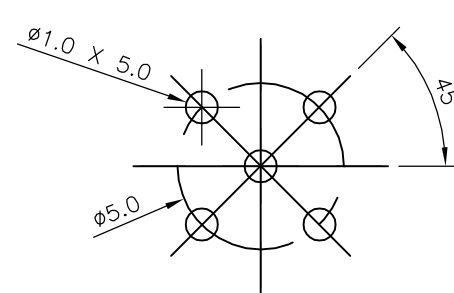
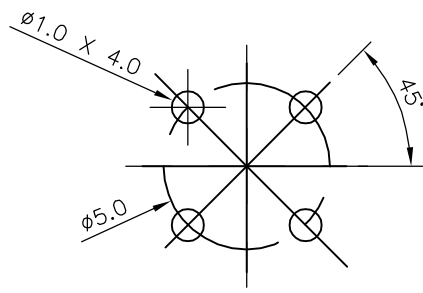
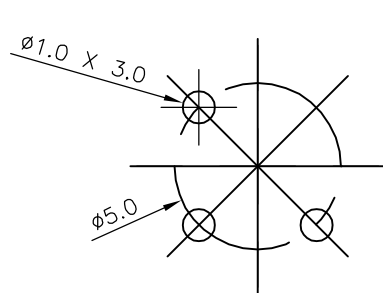

THIS DRAWING IS A CONTROLLED DOCUMENT.

DWN A.Morey 09MAR06

CHK F.Wheeler-King 12APR06

APVD F.Wheeler-King 12APR06

PRODUCT SPEC

APPLICATION SPEC

WEIGHT -

CUSTOMER DRAWING

DIMENSIONS:
mm

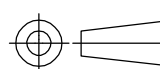

TOLERANCES UNLESS OTHERWISE SPECIFIED:

- 0 PLC ± -
- 1 PLC ± -
- 2 PLC ± -
- 3 PLC ± -
- 4 PLC ± -
- ANGLES ± -
- FINISH -

MATERIAL -

Tyco Electronics Corporation
Bideford, UK, EX39 4HE

NAME
M12 METAL FEMALE PANEL MOUNT CONNECTOR,
PCB, STRAIGHT, FRONT (HEXAGONAL) MOUNTING

SIZE	CAGE CODE	DRAWING NO	RESTRICTED TO
A3	00779	C-1838417	-

SCALE NTS SHEET 2 OF 2 REV A