

EE-SX3081/4081/3088(-W1)/4088(-W1)

PCB-mount Photo IC Output with Preamplifier Chip and Schmitt Circuit

- All models have a receiver and amplifier circuit built into a single chip
- Excellent temperature characteristics assured by receiver with a temperature compensation circuit
- Directly drive electronic circuitry with no interface
- Wide operating voltage range (4.5 to 16 VDC) makes smooth connection possible with CMOS or TTL
- Dark-ON and Light-ON models available
- High-resolution sensing assured by the aperture on both the emitter and receiver
- EE-SX3088-W1 and EE-SX4088-W1 wire harness versions provide easy, reliable solder-free connection



Ordering Information

Appearance	Sensing method	Slot width	Slot depth	Sensing object	Output configuration	Weight	Part number
	Transmissive	5 mm	7.5 mm	Opaque, 0.5 x 2.1 mm min.	Dark-ON	Approx. 0.5 g	EE-SX3081
Light-ON					EE-SX4081		
		3.4 mm			Dark-ON	Approx. 0.6 g	EE-SX3088
Light-ON					EE-SX4088		
					Dark-ON		EE-SX3088-W1
					Light-ON		EE-SX4088-W1

Specifications

■ ABSOLUTE MAXIMUM RATINGS

Item		Symbol	Rated value
Emitter	Forward current	I_F	50 mA*
	Reverse voltage	V_R	4 V
Receiver	Supply voltage	V_{CC}	16 V
	Output voltage	V_{OUT}	28 V
	Output current	I_{OUT}	16 mA
	Output permissible dissipation	P_{OUT}	250 mW*
Ambient temperature	Operating	T_{opr}	-40°C to 75°C (-40°F to 167°F)
	Storage	T_{stg}	-40°C to 85°C (-40°F to 185°F)

*Refer to Engineering Data if the ambient temperature is not within the rated temperature range.

■ RECOMMENDED OPERATING CONDITION (WITHIN THE RATED TEMPERATURE RANGE)

Item	Symbol	Recommended value	Remarks
Supply voltage	V_{CC}	4.5 to 16 V	—
Output current	I_{OUT}	16 mA max.	—
LED current	I_F	15 mA	$V_{CC} = 4.5$ to 16 V

■ CHARACTERISTICS ($T_A = 25^\circ\text{C}$ (77°F))

Item		Symbol	EE-SX3081/SX4081		EE-SX3088/SX4088	
			Value	Condition	Value	Condition
Emitter	Forward voltage	V_F	1.2 V typ.; 1.5 V max.	$I_F = 20 \text{ mA}$	1.2 V typ.; 1.5 V max.	$I_F = 20 \text{ mA}$
	Reverse current	I_R	0.01 μA typ.; 10 μA max.	$V_R = 4 \text{ V}$	0.01 μA typ.; 10 μA max.	$V_R = 4 \text{ V}$
Receiver	Low level output voltage	V_{OL}	0.12 V typ.; 0.35 V max.	$V_{CC} = 4.5 \text{ to } 16 \text{ V}$ $I_{OL} = 16 \text{ mA}$	0.12 V typ.; 0.4 V max.	$V_{CC} = 4.5 \text{ to } 16 \text{ V}$ $I_{OL} = 16 \text{ mA}$
	High level output voltage	V_{OH}	15 V min.	$V_{CC} = 16 \text{ V}$ $R_L = 1 \text{ k}\Omega$ $I_F = 8 \text{ mA}$	15 V min.	$V_{CC} = 16 \text{ V}$ $R_L = 1 \text{ k}\Omega$ $I_F = 5 \text{ mA}$
	Current consumption	I_{CC}	3.2 mA typ.; 10 mA max.	$V_{CC} = 16 \text{ V}$	3.2 mA typ.; 10 mA max.	$V_{CC} = 16 \text{ V}$
Combination	LED current when output is OFF	I_{FT}	8 mA max.	$V_{CC} = 4.5 \text{ to } 16 \text{ V}$	2 mA typ.; 5 mA max.	$V_{CC} = 4.5 \text{ to } 16 \text{ V}$
	LED current when output is ON					
	Hysteresis	ΔH^*	15% typ.	$V_{CC} = 4.5 \text{ to } 16 \text{ V}$	15% typ.	$V_{CC} = 4.5 \text{ to } 16 \text{ V}$
	Response frequency	f^{**}	3000 P.P.S min.	$V_{CC} = 4.5 \text{ to } 16 \text{ V}$ $I_F = 15 \text{ mA}$ $I_{OL} = 16 \text{ mA}$	3000 P.P.S min.	$V_{CC} = 4.5 \text{ to } 16 \text{ V}$ $I_F = 15 \text{ mA}$ $I_{OL} = 16 \text{ mA}$
	Response delay time	t_{PLH} (t_{PHL}) ^{***}	3 μs typ.		3 μs typ.	
t_{PHL} (t_{PLH}) ^{***}		20 μs typ.	20 μs typ.			

*Hysteresis denotes the difference in forward LED current value, expressed in percentage, calculated from the respective forward LED currents when the photo IC is turned ON and when the photo IC is turned OFF.

**The value of the response frequency is measured by rotating the disk as shown below.

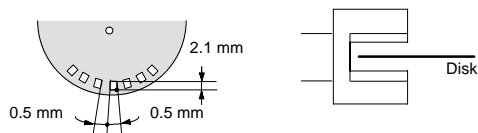

***The following illustrations show the definition of response delay time.

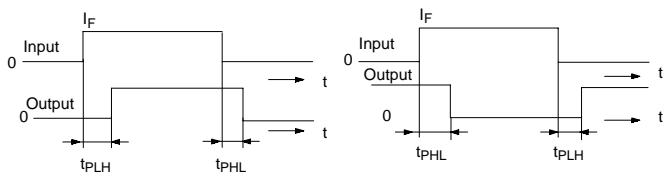

Operation

INTERNAL CIRCUIT DIAGRAM

Light ON/Dark ON

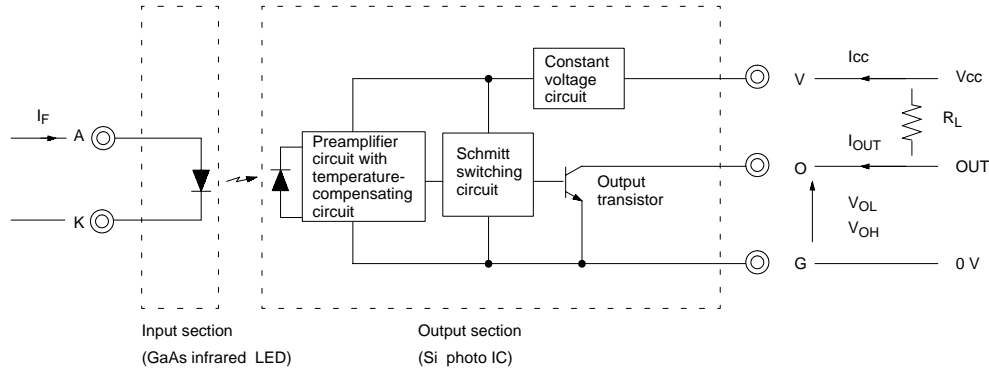

TIMING CHART

Light-ON

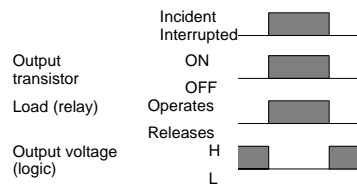

Dark-ON

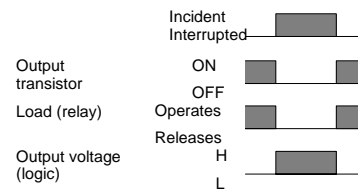

Engineering Data

- Note: 1. The operating conditions of the photomicrosensor must be within the absolute maximum rating ranges.
 2. Data in parentheses apply to the EE-SX4□□.

TEMPERATURE CHARACTERISTICS

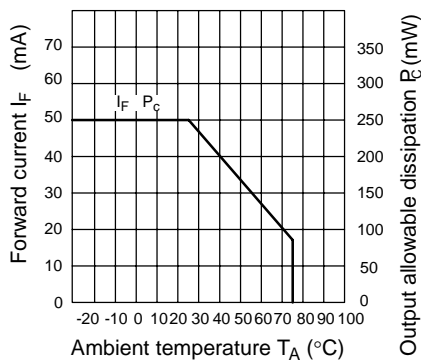

INPUT CHARACTERISTICS (TYPICAL)

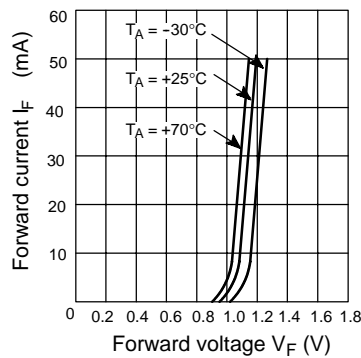

LED CURRENT VS. SUPPLY VOLTAGE (TYPICAL)

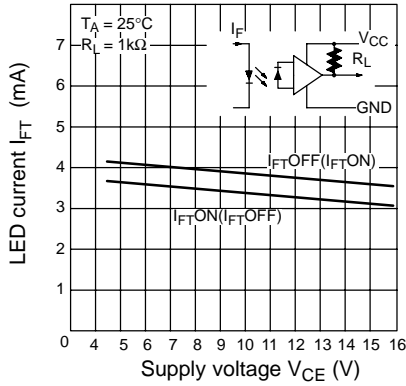

LED CURRENT VS. TEMPERATURE (TYPICAL)

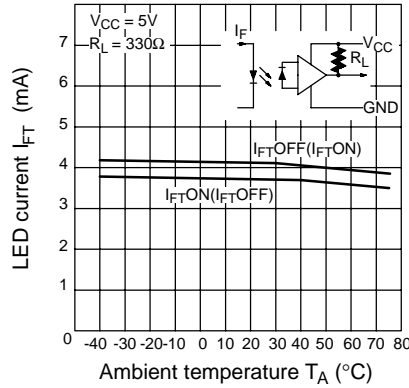

LOW LEVEL OUTPUT VOLTAGE TEMPERATURE DEPENDENCY (TYPICAL)

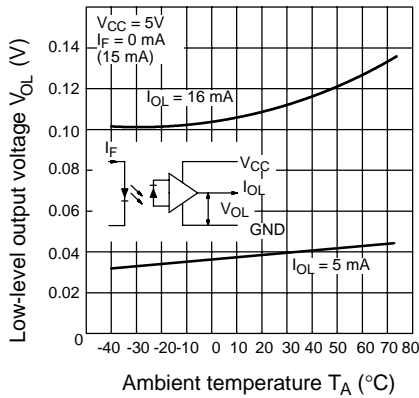

DEPENDENCY OF LOW LEVEL OUTPUT VOLTAGE ON OUTPUT CURRENT (TYPICAL)

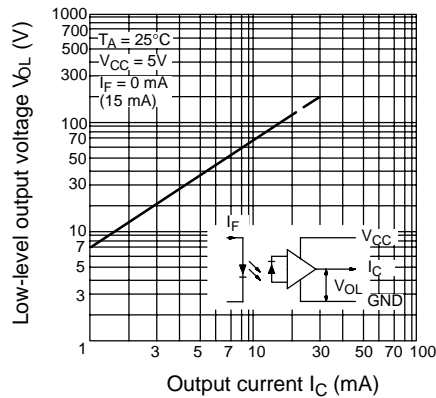

CURRENT VS SUPPLY VOLTAGE (TYPICAL)

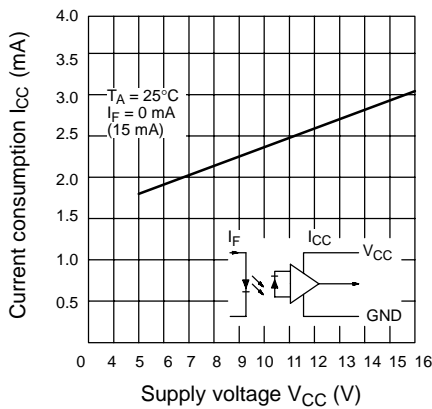

CURRENT VS SUPPLY VOLTAGE (TYPICAL)

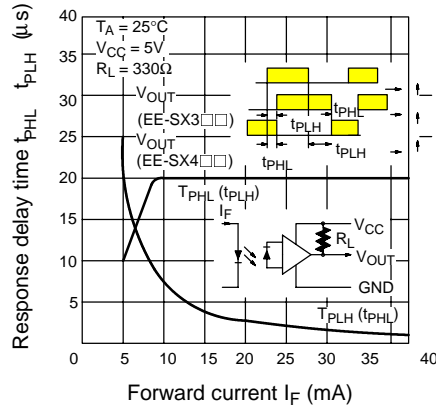

■ CURRENT VS SUPPLY VOLTAGE (TYPICAL)

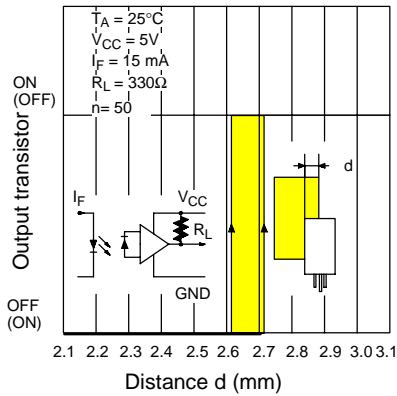

■ SENSING POSITION VS FORWARD CURRENT (TYPICAL)

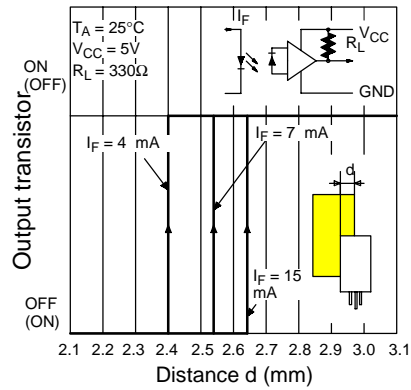

■ REPEATED SENSING POSITION CHARACTERISTICS (TYPICAL)

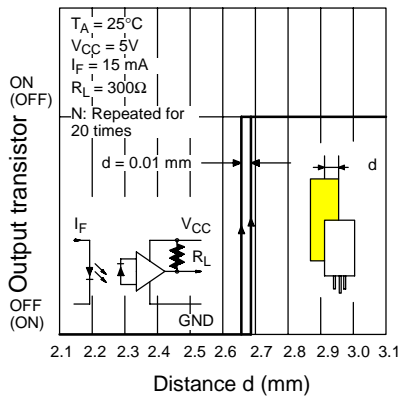

Dimensions

Unit: mm (inch)

■ EE-SX3081/4081

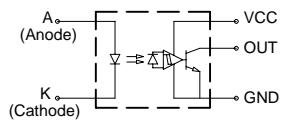
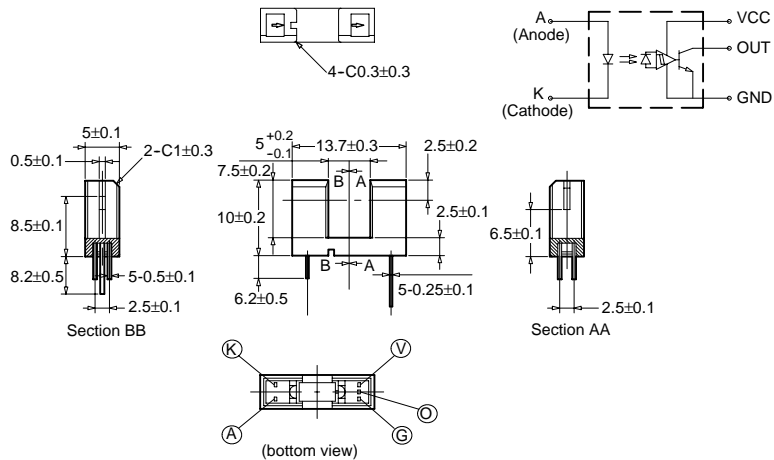
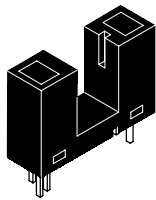

■ EE-SX3088/4088

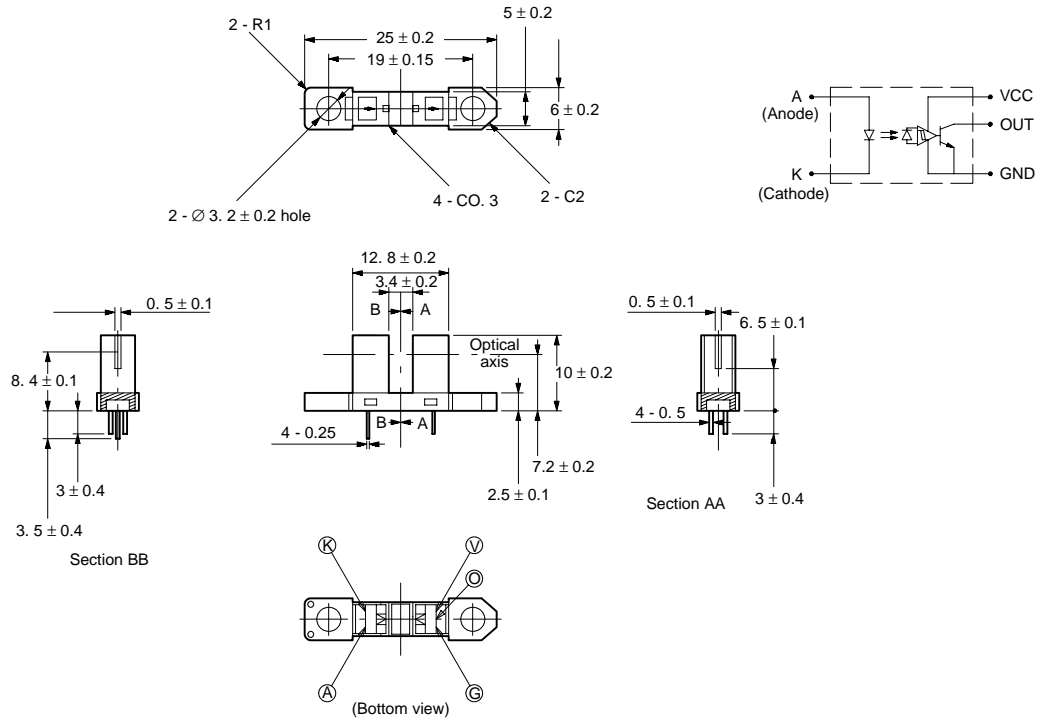
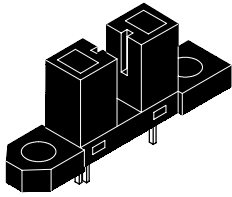

■ EE-SX3088-W1/4088-W1

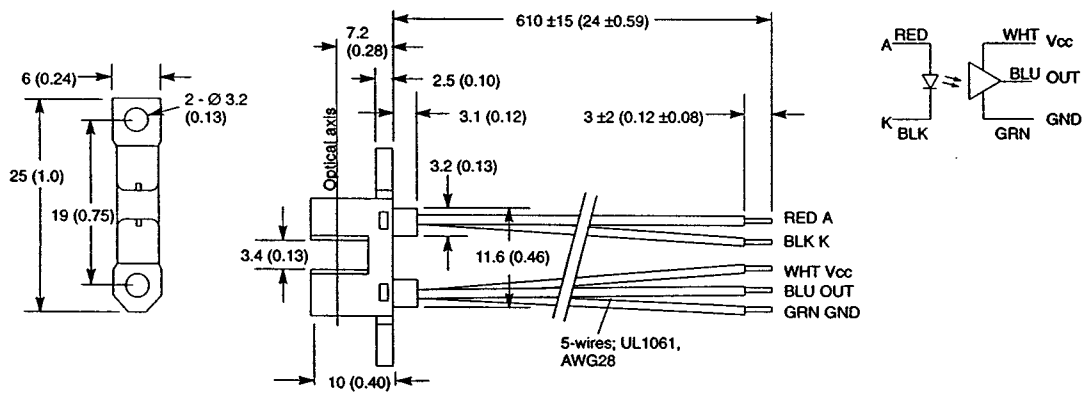
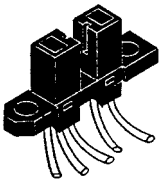

Precautions

Refer to the Technical Information Section for general precautions.

NOTE: DIMENSIONS SHOWN ARE IN MILLIMETERS. To convert millimeters to inches divide by 25.4.

OMRON[®]
OMRON ELECTRONICS, INC.
One East Commerce Drive
Schaumburg, IL 60173
1-800-55-OMRON

OMRON CANADA, INC.
885 Milner Avenue
Scarborough, Ontario M1B 5V8
416-286-6465