

General information

Part number	S12LOC-P26MCCO-9900
Termination	solder
Size	2
Locking principle	push
Coding	0_key
Cable Diameter	cable_mini_99
Cable outlet	standard

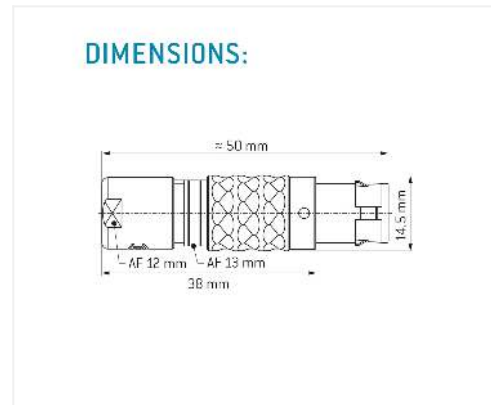
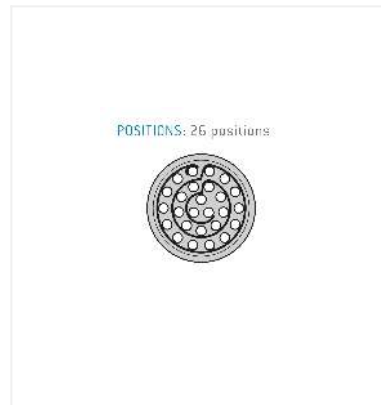

Contact insert description

Number of contacts	26
Contact type	pins
Contact diameter	05mm
Insulator material	peek
Wire cross section	28_awg
Termination	solder
Termination diameter	04mm

reverse_gender_on_request

Technical information

Max. creepage and air clearance distance	06_mm	11_mm
Nominal current single contact	04_a	iec_60512_5_2
Test voltage	09_kv_ac	sae_13441

safety_text

Mechanical and environmental data

Degree of protection*	ip50
Operating temperature	40_120_c
Mating cycles	5000

mated unmated

Material and surface treatments

Housing	m_chrome
Contact	cu_alloy_gold

safety_text_2
ul_text
illustrative_text