



AMPMODU

TE Internal #: 102694-3

Standard Rectangular Connectors, Connector Assembly, Housing for Female Terminals, Insulation Displacement (IDC), Wire-to-Board, Gold, High, UL 94V-0

[View on TE.com >](#)

Connectors > Rectangular Connectors > Standard Rectangular Connectors



- Connector Product Type: **Connector Assembly**
- Connector & Housing Type: **Housing for Female Terminals**
- Mating Alignment: **Without**
- Mating Retention: **Without**
- Termination Method to Wire & Cable: **Insulation Displacement (IDC)**

**Features**

**Product Type Features**

Connector Product Type	Connector Assembly
Connector & Housing Type	Housing for Female Terminals
Connector System	Wire-to-Board
Insertion Force Type	High
Sealable	No
Connector & Contact Terminates To	Wire & Cable

**Configuration Features**

Contacts Preloaded	Yes
Number of Loaded Positions	10
Number of Positions	10
Number of Rows	2

**Contact Features**

Contact Layout	Matrix
Wire Contact Termination Area Plating Material	Tin-Lead
Contact Underplating Material	Nickel
Contact Mating Area Plating Material	Gold
Contact Retention Within Housing	With
Contact Current Rating (Max)	3 A



### Termination Features

Termination Method to Wire & Cable	Insulation Displacement (IDC)
------------------------------------	-------------------------------

### Mechanical Attachment

Contact Retention Type Within Housing	Locking Lance
Mating Alignment	Without
Mating Retention	Without
Connector Mounting Type	Cable Mount (Free-Hanging)

### Housing Features

Centerline (Pitch)	2.54 mm[.1 in]
--------------------	----------------

### Dimensions

Connector Height	6.1 mm[.24 in]
Product Length	12.7 mm[.5 in]
Row-to-Row Spacing	2.54 mm[.1 in]
Wire Size	.13 – .3 mm <sup>2</sup>

### Usage Conditions

Operating Temperature Range	-65 – 105 °C[-85 – 221 °F]
-----------------------------	----------------------------

### Operation/Application

Shielded	No
Circuit Application	Signal

### Industry Standards

UL Flammability Rating	UL 94V-0
------------------------	----------

### Packaging Features

Packaging Quantity	250
Packaging Method	Tray

### Product Compliance

[For compliance documentation, visit the product page on TE.com>](#)

EU RoHS Directive 2011/65/EU	Not Compliant
EU ELV Directive 2000/53/EC	Compliant with Exemptions
China RoHS 2 Directive MIIT Order No 32, 2016	Restricted Materials Above Threshold
EU REACH Regulation (EC) No. 1907/2006	Current ECHA Candidate List: JUNE 2023 (235)



Candidate List Declared Against: JAN 2022  
(223)

SVHC > Threshold:

Pb (13% in COMPONENT PART)

**Article Safe Usage Statements:**

Do not eat, drink or smoke when using this product. Wash thoroughly after handling. Recycle if possible and dispose of the article by following all applicable governmental regulations relevant to your geographic location.

Halogen Content

Not Low Halogen - contains Br or Cl > 900 ppm.

Solder Process Capability

Not applicable for solder process capability

**Product Compliance Disclaimer**

This information is provided based on reasonable inquiry of our suppliers and represents our current actual knowledge based on the information they provided. This information is subject to change. The part numbers that TE has identified as EU RoHS compliant have a maximum concentration of 0.1% by weight in homogenous materials for lead, hexavalent chromium, mercury, PBB, PBDE, DBP, BBP, DEHP, DIBP, and 0.01% for cadmium, or qualify for an exemption to these limits as defined in the Annexes of Directive 2011/65/EU (RoHS2). Finished electrical and electronic equipment products will be CE marked as required by Directive 2011/65/EU. Components may not be CE marked. Additionally, the part numbers that TE has identified as EU ELV compliant have a maximum concentration of 0.1% by weight in homogenous materials for lead, hexavalent chromium, and mercury, and 0.01% for cadmium, or qualify for an exemption to these limits as defined in the Annexes of Directive 2000/53/EC (ELV). Regarding the REACH Regulation, the information TE provides on SVHC in articles for this part number is based on the latest European Chemicals Agency (ECHA) 'Guidance on requirements for substances in articles' posted at this URL: <https://echa.europa.eu/guidance-documents/guidance-on-reach>

## Compatible Parts



## Customers Also Bought

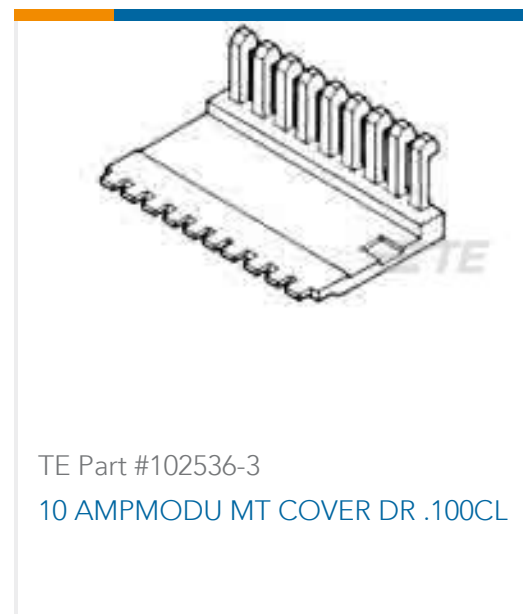

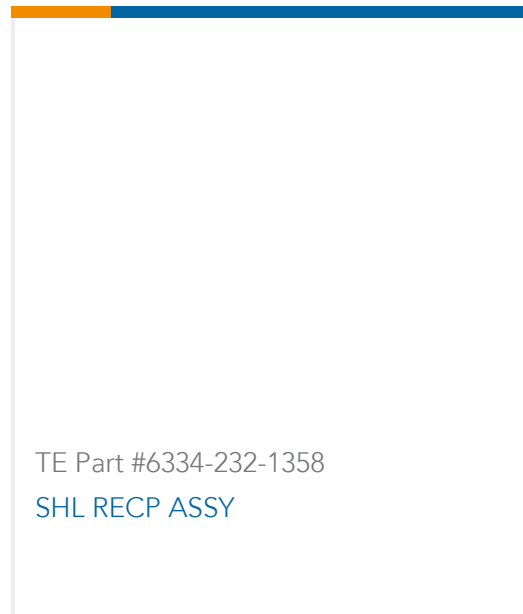
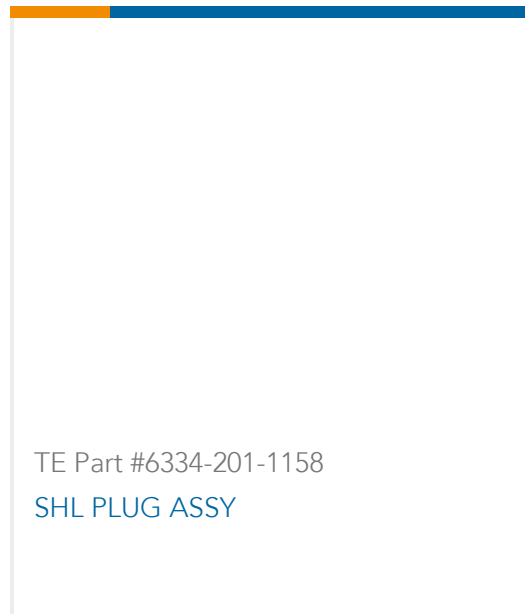
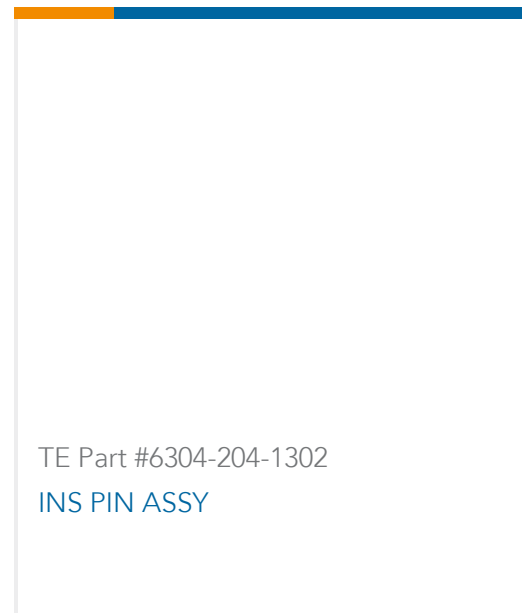
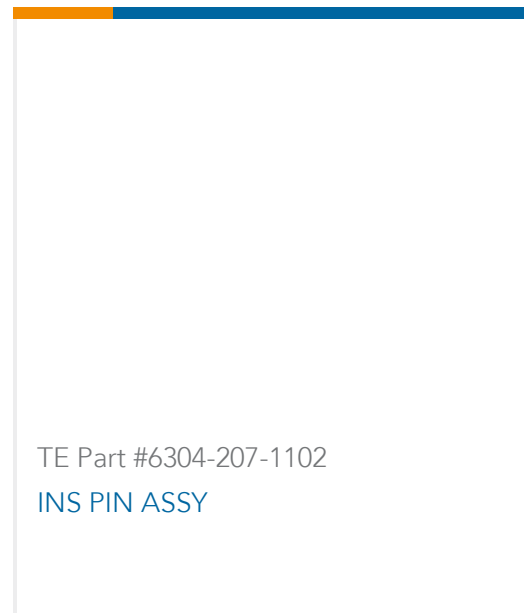
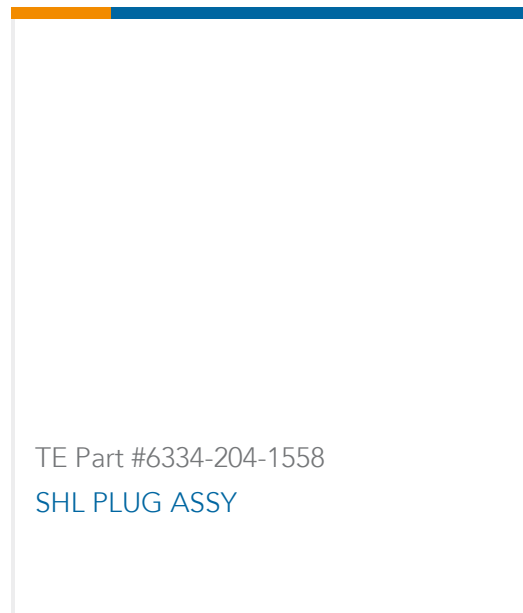
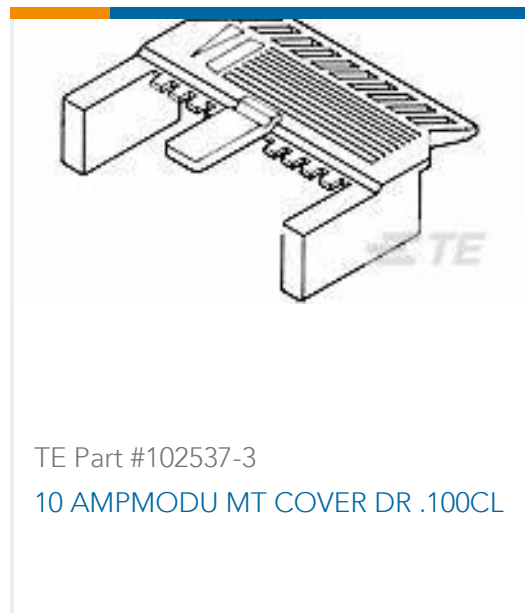

## Documents

### Product Drawings

[10 AMPMODU MT ASSY DR .100CL](#)

English

### CAD Files

[3D PDF](#)

English

**Customer View Model**

[ENG\\_CVM\\_102694-3\\_P.2d\\_dxf.zip](#)

English

**Customer View Model**

[ENG\\_CVM\\_102694-3\\_P.3d\\_igs.zip](#)

English

**Customer View Model**

[ENG\\_CVM\\_102694-3\\_P.3d\\_stp.zip](#)

English

By downloading the CAD file I accept and agree to the [Terms and Conditions](#) of use.

### Product Specifications

[Application Specification](#)

English