

l) tails to fit in PC-board layout

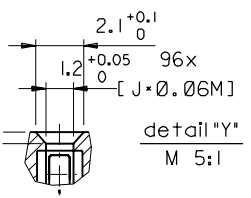
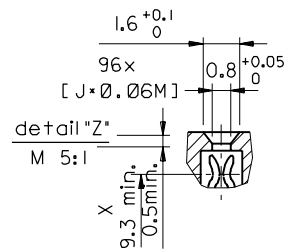
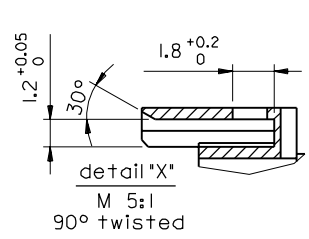
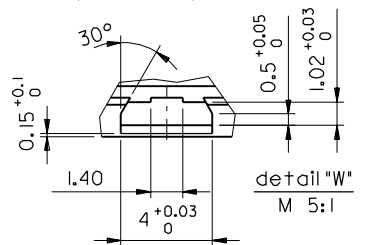
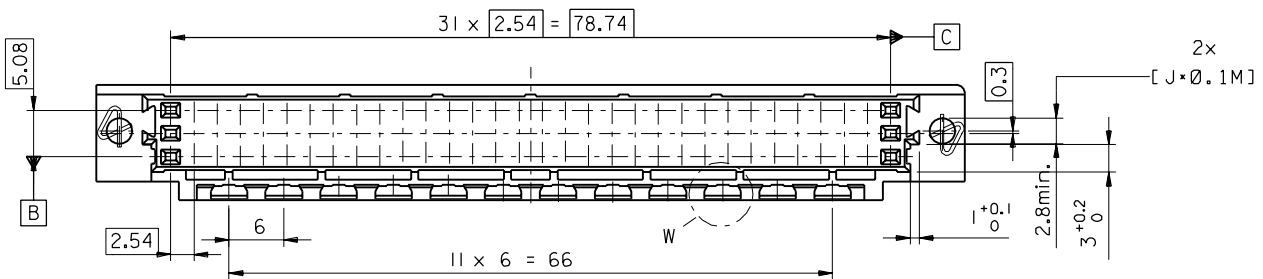
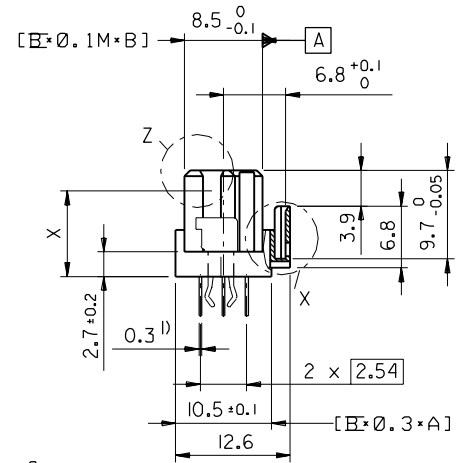
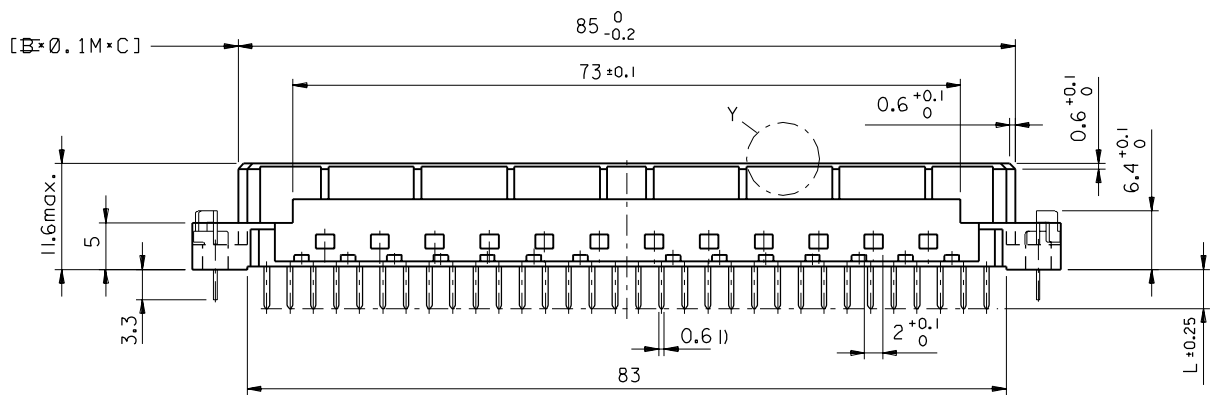

FIRST ANGLE PROJECTION		DRWG BY KN	SIGN
UNLESS OTHERWISE SPECIFIED TOLERANCES: ANGULAR ± 2°		CHK'D BY Ca	SIGN
3 PLACE ±	±	APP'D BY JB	SIGN
2 PLACE ±	±	SCALE	2:1
1 PLACE ±	±		
DRAFT WHERE APPLICABLE MUST REMAIN WITHIN DIMENSIONS			
DESIGN DIMENSION	<input checked="" type="checkbox"/> MM		
	<input type="checkbox"/> IN.		
EQUIVALENT DIMENSION	<input type="checkbox"/> MM		
	<input type="checkbox"/> IN.		
IF TWO DIMENSIONS ARE SHOWN THE UPPER IS THE DESIGN DIMENSION, LOWER IS SECONDARY			

REVISE ONLY ON CAD SYSTEM		SH.	REV.
CAD/CAM PROJECT NAME 85042000 s12		THIS DRAWING CONTAINS INFORMATION THAT IS PROPRIETARY TO MOLEX INC. & SHOULD NOT BE USED WITHOUT WRITTEN PERMISSION	
TITLE 96 pos. female connector DIN 41612 style C, + clip with coding, dimensions			
MOLEX MOLEX EUROPE		SHEET NO. DATE 2 of 2 96/04/30	
PART NO.	DWG NO.	SIZE	
SDA-85042-0001		B	

VIEW ON MATING SIDE

⊂	A	A	A	A	A	A	A	A	A	A	A	A	A	A	A	A	A	A	A	A	A	A	A	A	A	A	A	A	A	
⊃																														
⊄	A	A	A	A	A	A	A	A	A	A	A	A	A	A	A	A	A	A	A	A	A	A	A	A	A	A	A	A	A	A

1 2 3 4 5 6 7 8 9 10 11 12 13 14 15 16 17 18 19 20 21 22 23 24 25 26 27 28 29 30 31 32 33 34 35 36 37 38 39 40 41 42 43 44 45 46 47 48 49 50 51 52 53 54 55 56 57 58 59 60 61 62 63 64

A = 64 STANDARD CONTACTS L=4,5

Marking	Standard
Performance level	G2/0 = Contact area level2 / Termination tin
Flux proof	no
Fixing clip	no
Dimensions	SDA-85042-0001 sht.2
Technical Data	PS-85042-0001

A	G2/0	a1-32	c1-32
Contact symbol	Perform. level	Contact position number	

first release see ECN No. 2154	REVISIONS		FOR PREVIOUS REVISIONS SEE MRI LIST		REVISE ONLY ON CAD SYSTEM	SH. REV.	
	LTR		LTR		SH. REV.		
UNLESS OTHERWISE SPECIFIED TOLERANCES: ANGULAR ± 2° INCH METRIC		DRWG BY Ca	SIGN	CADCAM PROJECT NAME s8504201 s81	THIS DRAWING CONTAINS INFORMATION THAT IS PROPRIETARY TO MOLEX INC. & SHOULD NOT BE USED WITHOUT WRITTEN PERMISSION		
3 PLACE ± .	±	CHK'D BY KN	SIGN	TITLE 96 pos. female connector acc. DIN 41612 style C contacts arrangement			
2 PLACE ± .	±	APP'D BY	SIGN				
1 PLACE ± .	±	SCALE	SIGN	SHEET NO. DATE 1 OF 1 96/05/24			
DRAFT WHERE APPLICABLE MUST REMAIN WITHIN DIMENSIONS		DESIGN DIMENSION <input type="checkbox"/> MM <input type="checkbox"/> IN.	PART NO. DWG NO.				
EQUIVALENT DIMENSION <input type="checkbox"/> MM <input type="checkbox"/> IN.		SDA-85042-0189				SDA-85042-0189	
IF TWO DIMENSIONS ARE SHOWN, THE UPPER IS THE DESIGN DIMENSION, LOWER IS SECONDARY							