

zilog[®]

A **Littelfuse** Company



Zilog Standalone Programmer

User Manual

UM028704-0920



Copyright ©2018 Zilog®, Inc. All rights reserved

www.zilog.com

Zilog Standalone Programmer User Manual



Disclaimer



Warning

DO NOT USE THIS PRODUCT IN LIFE SUPPORT SYSTEMS.

LIFE SUPPORT POLICY

ZILOG'S PRODUCTS ARE NOT AUTHORIZED FOR USE AS CRITICAL COMPONENTS IN LIFE SUPPORT DEVICES OR SYSTEMS WITHOUT THE EXPRESS PRIOR WRITTEN APPROVAL OF THE PRESIDENT AND GENERAL COUNSEL OF ZILOG CORPORATION.

As used herein

Life support devices or systems are devices which (a) are intended for surgical implant into the body, or (b) support or sustain life and whose failure to perform when properly used in accordance with instructions for use provided in the labelling can be reasonably expected to result in a significant injury to the user. A critical component is any component in a life support device or system whose failure to perform can be reasonably expected to cause the failure of the life support device or system or to affect its safety or effectiveness.

Document Disclaimer

©2019 Zilog, Inc. All rights reserved. Information in this publication concerning the devices, applications, or technology described is intended to suggest possible uses and may be superseded. ZILOG, INC. DOES NOT ASSUME LIABILITY FOR OR PROVIDE A REPRESENTATION OF ACCURACY OF THE INFORMATION, DEVICES, OR TECHNOLOGY DESCRIBED IN THIS DOCUMENT. ZILOG ALSO DOES NOT ASSUME LIABILITY FOR INTELLECTUAL PROPERTY INFRINGEMENT RELATED IN ANY MANNER TO USE OF INFORMATION, DEVICES, OR TECHNOLOGY DESCRIBED HEREIN OR OTHERWISE. The information contained within this document has been verified according to the general principles of electrical and mechanical engineering.

S3 and Z8 Encore! are trademarks or registered trademarks of Zilog, Inc. All other product or service names are the property of their respective owners.

Zilog Standalone Programmer User Manual



Revision History

Each instance in the Revision History table below reflects a change to this document from the previous version.

Date	Rev	Description
2018 Apr	01	Original Issue
2018 Apr	02	Updated "Standalone Programming of Devices" section. Added a section named "How to use the External Controller Interface"
2018 Nov	03	Added Z8 Encore Family support
2020 Sept	04	Converted from chm to pdf file

Zilog Standalone Programmer User Manual



Overview

The Zilog Standalone Programmer (ZSP, Zilog PN: ZUSBZSP0100ZACG) is used to program Flash memory on Zilog's S3F8 and Z8 Encore! series of microcontrollers (MCU). Programming is performed through the S3F8 standard 10-pin In-System Programming (ISP) connector using the Serial Programming (SPGM) protocol (for S3F8 device) or the On-Chip Debug protocol for Z8 Encore! devices). Programming can be done by a human operator at the push of a button on the ZSP, or automatically by an external controller using the [6-pin External Controller Interface \(ECI\)](#) in combination with the ISP interface.

Prior to programming, the ZSP must be configured with information about the target MCU and the application Hex file to be programmed into Flash memory on target devices. This setup process is performed using the ZSP Configuration software on a PC running a supported version of Windows. The ZSP can be configured to program application Hex files generated with the Zilog Development Studio, or any other 3rd party toolset capable of generating Intel Hex files for the target MCU.

After initialization, the ZSP can erase, program, and verify the contents of Flash memory on target MCU devices independently of the development toolset (and PC) used to create the application Hex file. All that is required is a power source capable of delivering power through a standard Type-A to Mini-B USB cable.

This document describes the Zilog Standalone Programmer (ZSP) Kit, how to interface the ZSP to target devices and how to use the ZSP in standalone mode.

Zilog Standalone Programmer



Zilog Standalone Programmer

User Manual



Kit Contents

The Zilog Standalone Programmer Kit PN: ZUSBZSP0100ZACG contains the following items:

Item	Description	Quantity
1	Zilog Standalone Programmer (ZSP)	1
2	Type-A(male) to Mini-B(male) USB cable	1
3	10-wire ribbon cable	1
4	Zilog Standalone Programmer Kit hardcopy insert (FL0191)	1

Optional Hardware

The ZSP can be powered by a PC with USB port or wall power supply capable of supplying 5V at 200mA. Using a USB wall adapter allows the ZSP to program targets in standalone mode.

Zilog Standalone Programmer Kit





Supported Target Environments

The Zilog Standalone Programmer supports the following targets:

- Zilog S3 MCU
- Zilog Z8 Encore! MCU
- Programming socket, or PCB, with Zilog S3 and a [10-pin ISP II connector](#)
- Programming socket, or PCB, with Zilog Z8Encore and a [10-pin ISP II connector to 6pin DBG adapter](#)



10 Pin ZSP/ISP II Connector - S3 MCU

The Zilog Standalone Programmer interfaces to any target PCB (or programmer) through the supplied 10-wire ribbon cable that terminates in a 2x5 female connector. Pin 1 of the ribbon cable is marked by a red wire. The target PCB must include a male 2x5 header (standard 0.025 inch square posts on 0.1 inch centers; FCI part number 67997-210HLF). This same 2x5 header is used on all Zilog S3 development boards as a connection point for the S3 Flash ISP II (and most other 3rd party S3 in-circuit programmers). In the remainder of the document this PCB header for S3 MCU is referred to as the ZSP/ISP II connector.

The figure below shows the connection between the ZSP/ISP II connector and the S3 Flash MCU. When connecting the ribbon cable to the target board, ensure that Pin 1 of the cable is aligned with Pin 1 of the connector on the board.

ZSP/ISP II Connector to S3 MCU Schematic

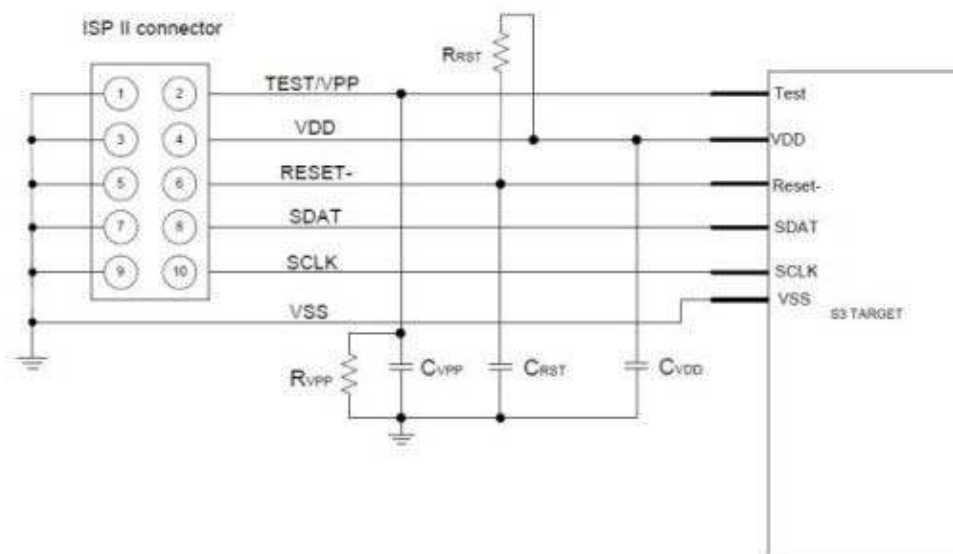



ZSP/ISP II Interface

The ZSP/ISP II interface consists of the following signals:

TEST/VPP	Test Mode signal; when driven High, this signal places the S3 Flash MCU into Test Mode to make on-chip Flash memory available for programming by the ZSP/S3 Flash ISP II. For proper ZSP operation, a 0.1 μ F capacitor and 10KOhm resistor should be placed in parallel between this pin and Ground, as shown in the figure above.
RESET	Input; an active Low signal that resets the S3 Flash MCU.
SDAT	Serial data; bidirectional signal.
SCLK	Serial clock; input for the S3 Flash MCU
VDD, VSS	Power

Zilog recommends keeping the traces connecting SCLK and SDAT to the ZSP/ISP II connector as short as possible. Table below shows the recommended values for the passive components in the above ZSP/ISP II circuit.

ISP II Signal (Pin Number)	Passive Component	Notes
TEST/VPP(2)	$C_{VPP} = 0.1\mu F$ $R_{VPP}=10K$	If the S3 MCU has a shared Vpp/Reset pin, connect the ZSP/ISP II Vpp/Test pin to the MCU Vpp/Test pin.
VDD(4)	$C_{VDD} = 0.1\mu F$.
RESET(6)	$C_{RESET} = 0.1\mu F$ $R_{RESET}=10K$.
SDAT(8) SCLK(10)	.	.
GND (1,3,5,7,9)	.	Connect all odd number pins of the ZSP/ISP II connector to GND on the target board and S3 MCU.

Target Power

During programming, the ZSP applies power to the target and can supply up to 100mA of current. If the target board requires more current, an external power source with output voltage matching the

Zilog Standalone Programmer User Manual



Settings > Device > Target Voltage setting can be connected to the target:

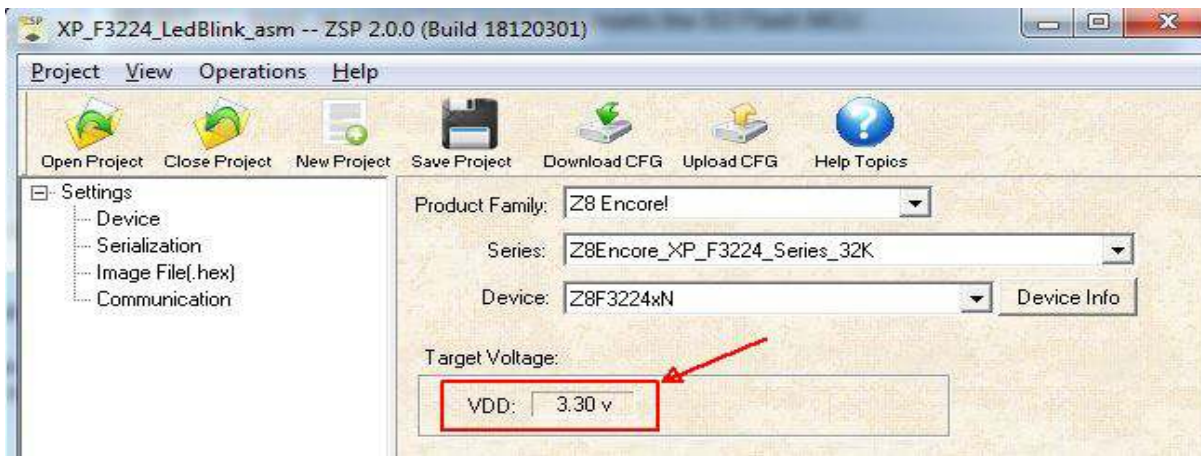

Ground

Ensure there is a good ground connection between the S3 Flash MCU and the ZSP/ISP II connector to avoid injecting noise into SDAT

Zilog Standalone Programmer User Manual



10 Pin ZSP/ISP II Connector with 6 pin Adapter - Z8Encore! MCU

The Zilog Standalone Programmer interfaces to any target PCB (or programmer) through the supplied 10-wire ribbon cable that terminates in a 2x5 female connector. A 10-pin Male connector to 6-pin Female adapter (not supplied) is needed to connect the ribbon cable to an Encore Target MCU. The target PCB must include a male 2x3 header (standard 0.025 inch square posts on 0.1 inch centers). This same 2x3 header is used on all Zilog Z8 Encore! development boards as a connection point for the USB Smartcable. In the remainder of the document this Z8 Encore PCB header is referred to as the DBG connector.

The figure below shows the connection between the ZSP/ISP II connector and the 10-pin to 6-pin adapter. When connecting the ribbon cable to the target board, ensure that Pin 1 of the cable is aligned with Pin 1 of the connector on the board.

ZSP/ISP II Connector to DBG Connector Adapter Schematic

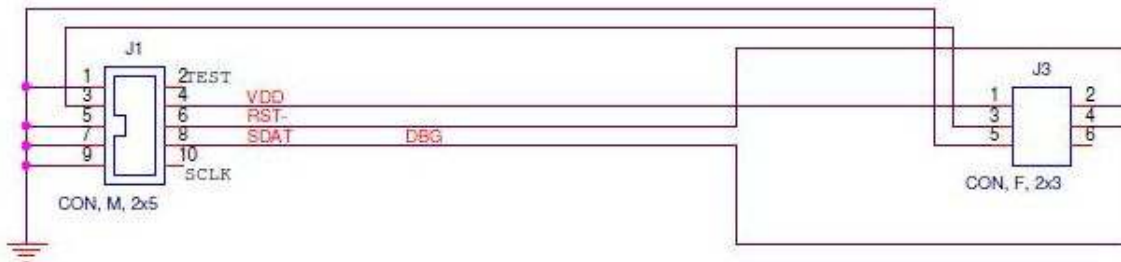

This is the recommended schematic to interface ZSP's 2x5 pin connector to Z8Encore! 2x3 pin connector. Do not use long wires!

**Note:**

When programming Z8 Encore MCU devices that do not have an Internal Precision Oscillator (IPO) an external Crystal is needed for programming. Please see the MCU's Product Specification for reference.

ZSP/ISP II Interface

The ZSP/ISP II interface consists of the following signals:

VDD, VSS	Power
RESET	Input; an active Low signal that resets the Z8Encore Flash MCU.
DBG	Serial data; bidirectional signal.

Target Power

During programming, the ZSP applies power to the target and can supply up to 100mA of current. If the target board requires more current, an external power source with output voltage matching the Settings > Device > Target Voltage setting can be connected to the target:

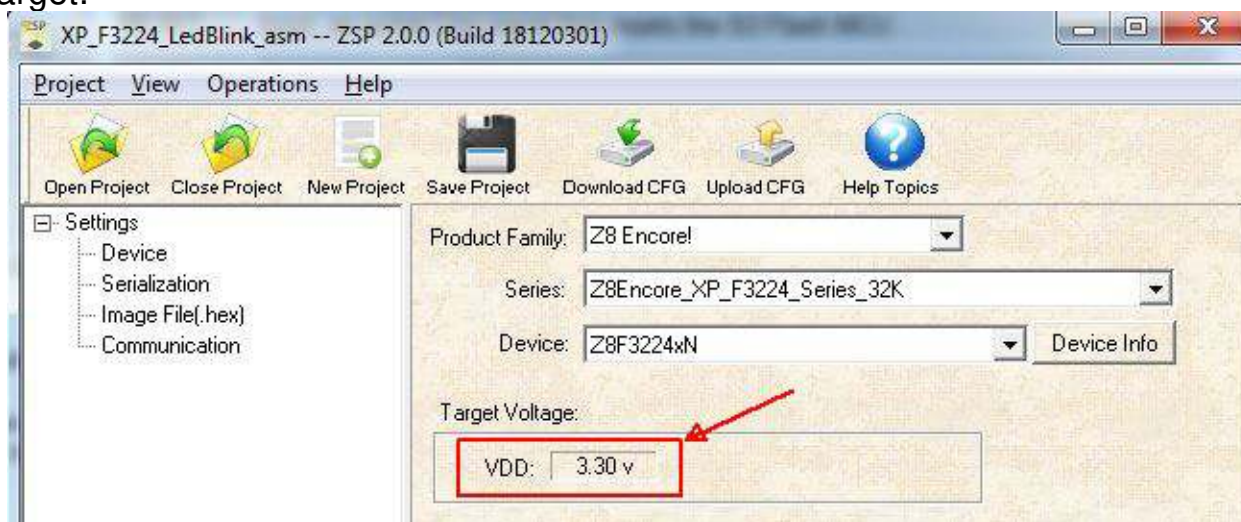

Zilog Standalone Programmer User Manual



Ground

Ensure there is a good ground connection between the Z8 Encore! Flash MCU and the ZSP/ISP II connector to avoid injecting noise into the DBG signal



6-Pin ECI Connector

The Zilog Standalone Programmer interfaces to an external controller through the 6-pin External Controller Interface (ECI). This interface allows the external controller to initiate device programming (via the ZSP/ISP II interface). Feedback signals in the ECI indicate when the programming operation completes and whether the operation was successful. The ZSP ECI header is a male 2x3 header strip (standard 0.025" square posts, 0.1" pitch).

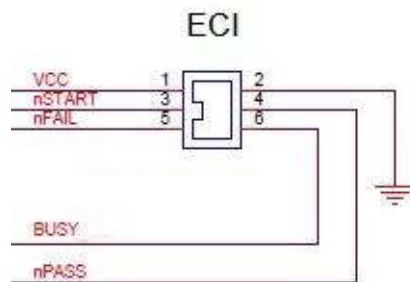

Table below describes the ECI connector pin-out:

Pin	Signal Name	Function	Active State	ZSP Direction
1	VCC	Power 5VDC. Do not use to power external device.	NA	Output
2	GND	Power GND	NA	NA
3	nSTART	The external controller drives this pin low to initiate a programming operation. The nSTART signal should be set to VCC (logic 1) by the external controller for a minimum of 100uS to allow the ZSP to prepare for the falling edge of nSTART.	Falling Edge	Input
4	nPASS	Asserted by the ZSP at the end of device programming if the data read back from the target matches the image file programmed into the target. The ZSP drives nPASS to VCC when BUSY is asserted.	LOW	Output

Zilog Standalone Programmer

User Manual



5	nFAIL	Asserted by the ZSP at the end of device programming if the data read back from the target does not match the image file programmed into the target or an error is detected during programming. The ZSP drives nFAIL to VCC when BUSY is asserted.	LOW	Output
6	BUSY	The ZSP drives this pin to VCC while a programming operation is in progress, While BUSY is asserted, the ZSP ignores the nSTART signal.	HIGH	Output

Figure below shows the ECI connector location.





ECI Signal Timing

The figure below is a timing diagram showing the relationship between ECI signals during programming.

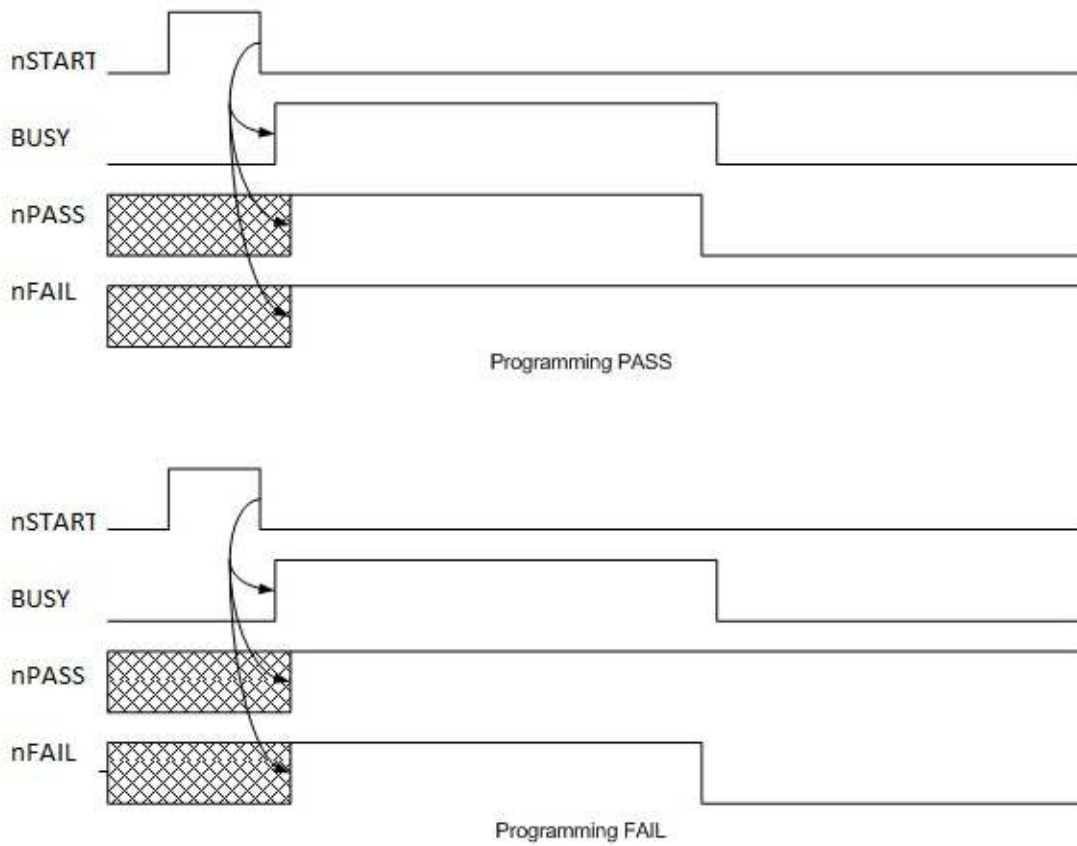



Installing the ZSP Configuration Software and Drivers

Download ZSP Configuration Software from Zilog [Software Downloads](#) page. Run the software installation file and follow the on-screen instructions. Be sure to install the “Zilog Standalone Programmer (ZSP) driver software” if prompted during the installation. If the ZSP USB drivers are not installed, it will not be possible for the ZSP Configuration Software to download target information and/or an image file into the ZSP and the ZSP will not be able to program any target devices.

Click [here](#) for more information about the operation of the Zilog Standalone Programmer Configuration Software, or refer to the integrated help files by pressing F1 while the ZSP Configuration Software is in focus.

Supported Operating Systems

- Windows XP 32-bits (SP3)
- Windows 7 32 and 64-bits
- Windows 8 32 and 64-bits
- Windows 10 32 and 64-bits

Connecting to the Target

Observe the following procedure to safely connect the ZSP to the target board.

1. Connect the 10-pin ribbon cable to the ZSP as shown in the figure below.
2. Connect the other end of the ribbon cable to the target/programmer board. Observe that Pin 1 of the target board connector is connected to Pin 1 of the ribbon cable. Pin 1 of the ribbon cable is marked by a red wire on the cable.
3. Connect the (male) Mini-B USB connector into the (female) USB receptacle on the ZSP
4. Connect the (male) Type A connector of the same USB cable into the (female) receptacle on the power source. The ZSP yellow power LED will then will illuminate.
 - If the ZSP contains a valid target configuration and image file, then the status LED will turn yellow and the LCD will display the image file checksum.
 - If the ZSP does not contain a valid target configuration and image file, then the status LED will not turn yellow and the LCD panel will display four hyphens "----".

The figure below shows the ZSP connected to a Zilog Development board.

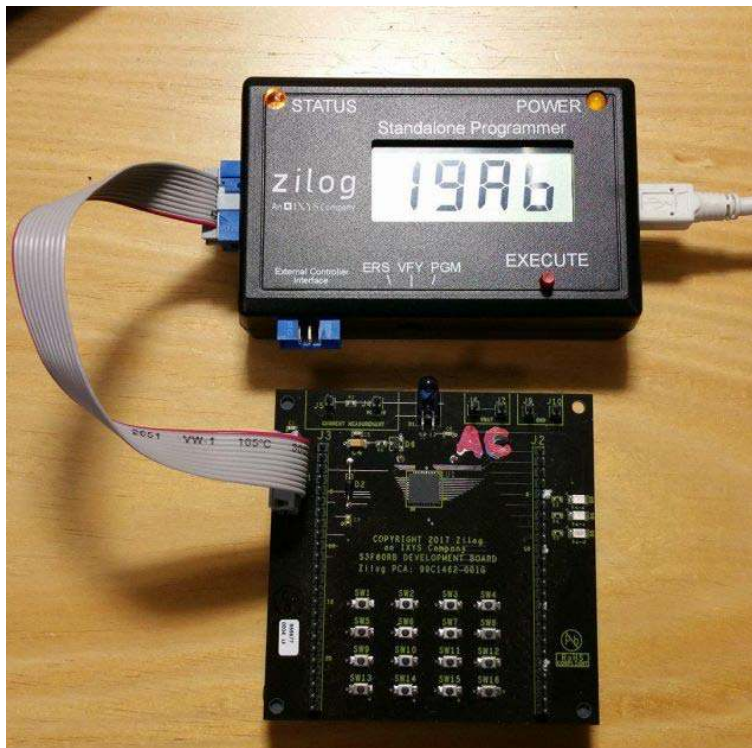



Standalone Programming of Devices

After successfully downloading target information and an application image (Hex) file into the ZSP dongle, the ZSP can be used in standalone mode. The following operations can be performed:

Verify(VFY)

Target memory is compared against the ZSP image file used for programming. If all data matches, then the status LED turns green, the checksum of target memory is displayed on the LCD panel, and the ZSP emits a sequence of three short beeps to indicate the operation succeeded. If the data does not match, the status LED turns red, the LCD panel displays one of the [ZSP Error Codes](#) (negative number) for approximately 2 seconds, and the ZSP emits 1 long beep. Regardless of whether the target configuration includes serialization, target serial numbers are ignored during device verification. For the S3 Family of devices, the Smart Option and Protection bits are also verified before indicating whether the operation succeeded.

Program(PGM)

Target memory is erased (see ERS below) and the image file previously downloaded into the ZSP is programmed into the target. If the target configuration includes serialization, then the ZSP also programs the next sequential serial number into target Flash (and internally increments the target serial number). For the S3 Family of devices, the ZSP programs the Smart Option and Protection bits according to the previously downloaded configuration information. After programming the target, serial number and smart options, the ZSP automatically performs a verify operation (see VFY above). If the verify operation succeeds, the Protection bits are also programmed.

Erase (ERS)

For the S3 family of devices, erasing target memory also erases the Smart Option and Protection bits. If the erase operation succeeds, then the status LED turns green, the checksum of target memory is displayed on the LCD panel, and the ZSP emits a sequence of three short beeps. If the operation fails, then the status LED turns red, the LCD panel displays one of the [ZSP Error Codes](#) (negative number) for approximately 2 seconds, and the ZSP emits 1 long beep. It is not necessary to manually erase the contents of target Flash prior to initiating a programming operation (see PGM above).

To perform an operation in standalone mode, move the slider below the LCD panel into desired position (ERS, VFY, or PGM) and press the EXE button. While the requested operation is in progress, the Yellow power LED blinks.

Zilog Standalone Programmer User Manual



The recommended procedure for programming a target in standalone mode follows:

1. Connect the **ZSP** using the supplied USB cable to the host PC or wall adapter.
2. Connect the **ZSP** using the supplied 10-pin circuit cable to the target/programmer board.
3. Place the MCU on the Zero Insertion Force (**ZIF**) socket.
4. Slide the switch to the **PGM** position.
5. Press the **EXE** button.
6. After the operation completes, the status LED turns green if the operation succeeded and the ZSP emits a sequence of three short beeps. If the operation failed, the status LED turns red, the LCD panel displays one of the [ZSP Error Codes](#) (negative number) for approximately 2 seconds, and the ZSP emits 1 long beep. For successful Program and Verify operations, the checksum of the contents of target Flash memory are displayed on the LCD.
7. Remove the MCU from the **ZIF** socket.

The figure below shows the ZSP connected to a programming board containing a Zero Insertion Force socket.





Checksum

The checksum is calculated by adding the contents of every memory location in the target's Flash address space (from 0 to end of Flash memory). Memory locations that were not programmed by the ZSP contain the value 0xFF since Flash memory is erased (all bits set to 1) prior to programming. The checksum is displayed in hexadecimal using the numerals 0-9 and the letters A, b, C, d, E, and F as shown in the following examples:



For the S3 family of devices, the verify operation automatically performed after programming does not compare the protection bits; but the protection bits are verified on subsequent verify operations. Note that when S3 read protection is enabled, the ZSP will read back 0x00 for all bytes of target Flash and consequently all verify operations will fail.

Zilog Standalone Programmer User Manual



How to use the External Controller Interface

The recommended procedure for programming a target using the ECI port is:

1. Connect the ZSP to a PC (or wall adapter) using the supplied USB cable.
2. Attach one end of the 10-pin ZSP/ISP II ribbon cable to the ZSP and the other end of the cable to the target board/ socket to be programmed or to the external controller (ATE, device/ gang programmer/ replicator) used for device programming. Refer to the 10 Pin ZSP/ISP II Connector section for signal information.
3. Attach one end of the 6-pin ECI ribbon cable to the ZSP and the other end of the cable to the External Controller. Refer to the [6-pin ECI Connector](#) section for signal information.
4. Activate the External Controller to initiate device programming.



Zilog Standalone Programmer User Manual



LED Indicators

There are two LED on the top panel of the ZSP:

Status (upper left) Tri-colour LED used to indicate the following conditions based on the color of the LED:

- Green (Pass)The requested operation completed successful
- Red (Fail)The requested operation could not be completed due to an error. When an error occurs, the LCD panel typically displays a negative number indicating a possible cause for the error. For more information refer to the [ZSP Error Codes](#) section. Error codes are displayed on the LCD panel for approximately 2 seconds before reverting to what was displayed previously.
- Yellow(File)In the Beta version of the ZSP firmware, the status LED turns yellow after the ZSP is powered if the ZSP contains a valid ZSP target configuration and image file. When the ZSP is powered for the first time, it will not contain any target information or a target image file. Therefore the status LED will not turn yellow. In addition, the LCD panel will display four hyphens "----" to indicate that the ZSP has not been configured. If the status LED is not yellow after being powered, then any attempt to program or verify a target will fail (status LED turns red). Once the ZSP Configuration Software is used to configure the ZSP with target information and an image file, the status LED will turn yellow and the LCD panel will display the checksum of the Hex file downloaded in the ZSP using the ZSP Configuration software.indicating the ZSP is ready for standalone operation. The meaning of a yellow status LED could change before the ZSP production release.

Power (upper right) Yellow LED that is illuminated once the ZSP is powered. The power LED blinks while long running erase, program, or verify operations are in progress.





ZSP Error Codes

When the ZSP detects an error, the status LED turns red and stays illuminated until the next standalone operation is performed, or until the 10-wire ribbon cable is disconnected from the target. In addition, an error code (a negative decimal number) is displayed on the LCD panel for approximately two seconds. After two seconds, the LCD panel returns to the state it was in prior to the error condition. Common error codes, their meaning, and ideas for resolving the problem are listed in the Table below. If an error code is displayed that is not listed in the table, please contract Zilog technical support.

Error Code	Error Condition	Description and Troubleshooting
-5	SPGM Bus Error	While programming or erasing target memory on an S3 device, an unexpected bus error was detected. This condition could indicate ZSP power failure or electrical problems on the ZSP/ISP II interface (including if the ZSP/ISP connector is disconnected during programming/verify operations).
-6	Target Not Present	An attempt was made to program, erase, or verify an S3 target device, but there is no S3 device connected to the ZSP/ISP II connector.
-8	Invalid Address	This condition might occur while downloading a target image if the file is too large for the ZSP internal memory. This condition is unexpected when downloading image files for S3 devices with less than 64KB of Flash.
-9	Verify	This error can be displayed if a verify operation fails. It indicates that a byte of memory read from target Flash does not match the expected value. If this error occurs, try programming the target again (move slider to PGM position and press the EXE button). If the error occurs again, try erasing the target (move slider to the ERS position and Press EXE button) and then reprogram the target. If the problem still persists, connect the ZSP to a PC running the ZSP Configuration Software and click the Clean ZSP Configuration and Image area start button (in the Communication view) and then click the Download CFG toolbar icon. After the ZSP has been reset, try programming in standalone mode again.
-10	Smart Option	This error occurs if the Smart option data read from an S3 target does not match the expected value(s). Refer to error -9 (Verify) for more information.

-11	Protection Bits	This error occurs if the value of the Protection bits read from an S3 target does not match the expected value(s). Refer to error -9 (Verify) for more information.
-12	Checksum	This error occurs if the checksum value computed over the target memory range does not match the expected value Refer to error -9 (Verify) for more information.
-13	Invalid State	The ZSP was directed to perform an unexpected action given its current operating mode. This could occur if the user attempt to program a target in standalone mode before the ZSP has been configured with target information and a valid target image file.
-14	OCD Failure	OCD transaction failed (time-out waiting for response).
-15	Auto-baud Failure	Auto-baud algorithm failed to determine an appropriate OCD baud rate.
-16	Z8 Encore Read Protect	Z8 Encore Read protection enabled. Target must be mass-erased to disable.
-17	Z8 Encore Write Protect	Z8 Encore Write protection enabled. Target must be mass-erased to disable.
-18	Z8 Encore Mass Erase	Z8 Encore Mass Erase Failure
-19	Z8 Encore Program Failure	Z8 Encore Program Failure (OCD baud rate \leq target byte-programming frequency).
-20	ZSP Locked	Password required to unlock password-protected ZSP operation.
-21	Program Counter (PC) Expired	ZSP unable to program target devices when PC=0. To correct: reset or disable PC, disable password-protection, or erase ZSP Configuration and Image Area.

-127 Reset

This error condition indicates that the ZSP has detected an unrecoverable fault and is in the process of erasing Flash memory used to store target configuration information and Hex image files. It can take almost one minute for this action to complete. During this time, the ZSP status LED blinks on and off and the LCD display flashes -127. When the internal reset is complete and the ZSP is ready to be reconfigured by the ZSP Configuration Software, the LCD panel displays four hyphens “----“ indicating it is not configured and the status LED stops blinking but stays red. At this point, it will be necessary to download new configuration information and an image file into the ZSP before it can be used in standalone mode again.

This error typically only occurs in rare circumstances if the ZSP loses power while being configured by the host and is then powered on while the contents of the ZSP data store are in an indeterminate state. To avoid this error, do not disconnect the ZSP USB cable while the ZSP configuration SW is downloading configuration information into the ZSP. Similarly, do not disconnect the ZSP USB cable while the LCD display is Flashing -127 since this will leave the internal data store in an indeterminate state and could cause this error to occur again.

Zilog Standalone Programmer User Manual



Customer Support

To share comments, get your technical questions answered, or report issues you may be experiencing with our products, please visit Zilog's Technical Support page at <https://support.zilog.com>.

To learn more about this product, find additional documentation, or to discover other facets about Zilog product offerings, please visit the [Zilog Knowledge Base](#).

This publication is subject to replacement by a later edition. To determine whether a later edition exists, please visit the Zilog website at <http://www.zilog.com>