

**MOSFET BASED
DC SOLID-STATE RELAY**
(With built-in transient voltage suppressor)

- ▶ Latest MOSFET technology generation.
- ▶ Ultra low on-state resistance.
- ▶ Low output leakage current.
- ▶ Low control current consumption.
- ▶ Built-in overvoltage protection (TVS)
- ▶ Reverse protected triggered control input to avoid linear control risks
- ▶ No radiated or conducted disturbances
- ▶ Touch protected housing IP20



SOM06075



Control voltage range	3.5-32VDC
Max transient peak voltage	75v
Max. DC Mains peak voltage	40VDC
Max. Load Current (with heatsink)	60ADC

DC Mains voltage range	Load current range	Control input voltage range	In & case / Out Insulation	Connections	Dimensions (WxHxD)	Weight
5-40VDC (75Vpeak)	Up to 60A (with heatsink)	3.5-32VDC	2.5kV	Screw terminals	45 x 58.5 x 30	80g

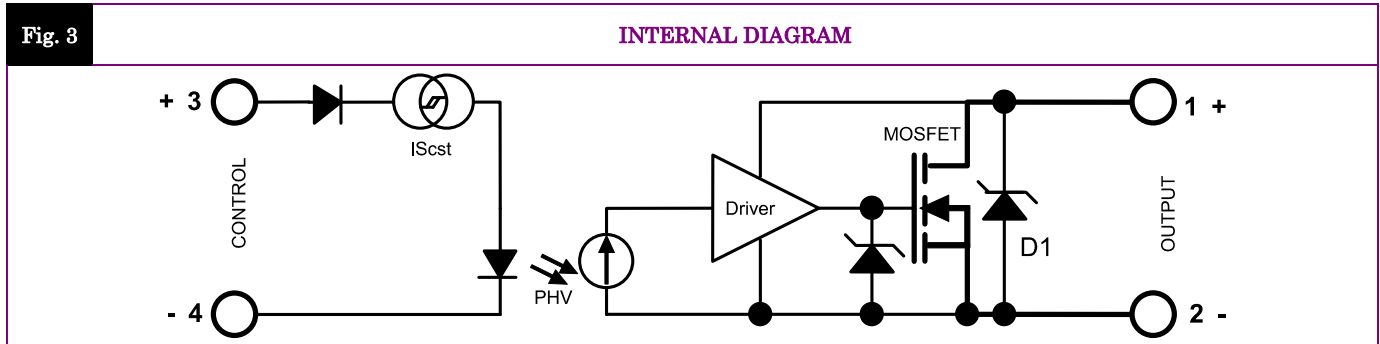
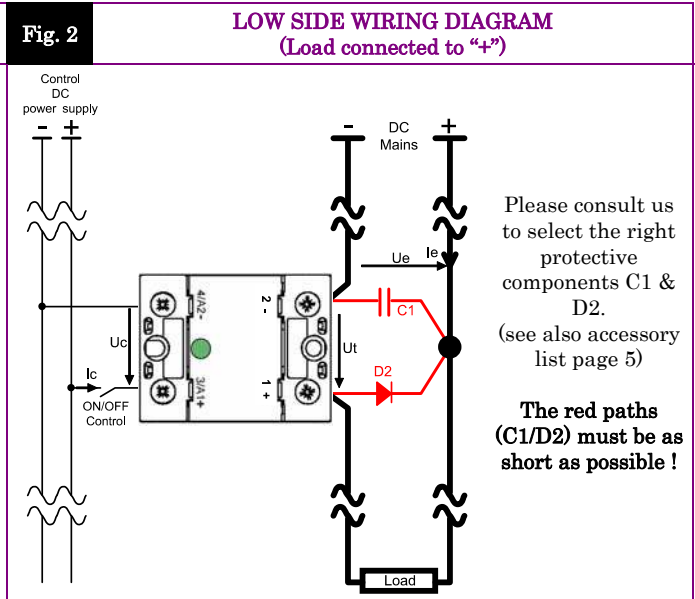
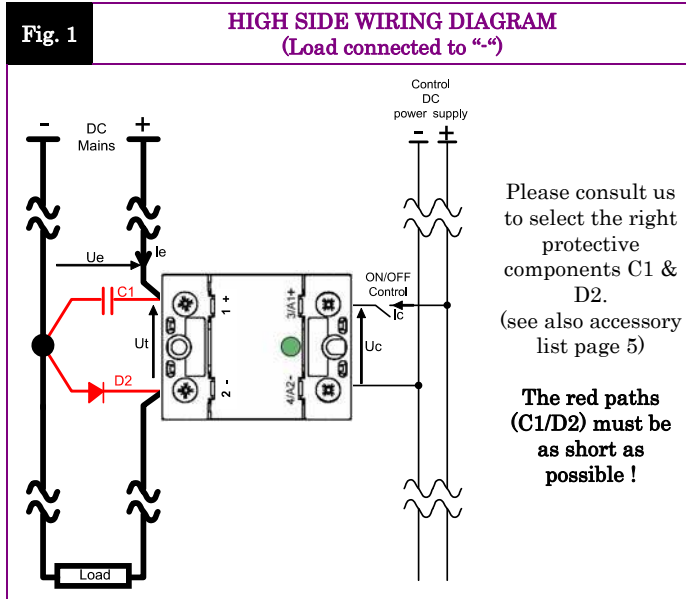

Proud to serve you

CONTROL INPUT CHARACTERISTICS

INPUT CIRCUIT	CHARACTERISTIC	LABEL	VALUE	INFO.	Fig. 4 CONTROL CURRENT vs. CONTROL VOLTAGE
	Nom. Control voltage	U_{Cnom}	12-24VDC		
	Nom. Control current	I_{Cnom}	35mADC	-100µA/°C	
	Control voltage range	U_c	3.5 – 32VDC	typical=3.3V	
	Control current consumption	I_c	32 – 35mADC	See curve	
	Releasing control voltage	U_{Coffmax}	1VDC	Typical= 2.6V	
	Max. reverse control voltage	-U_{Cmax}	32VDC	-I _{cmax} <100µA	
	Input impedance	R_{in}	Current limitation	See curve	

TIME CHARACTERISTICS

TIME CHARACT.	CHARACTERISTIC	LABEL	VALUE	<p>For high frequency, take 2 x I_e to calculate the heatsink; the protections must be chosen carefully. Please consult us if any.</p>
	Turn on time	ton	20µs	
	Turn on delay	tdon	20µs	
	Turn off time	toff	20µs	
	Turn off delay	tdoff	20µs	
Max. On-Off frequency	F_(on-off)	>1000Hz		

POWER OUTPUT CHARACTERISTICS

POWER CIRCUIT	CHARACTERISTIC	LABEL	VALUE	INFO.
	Nominal voltage	U_{enom}	24VDC	
	Voltage range	U_t U_e	5-40VDC	U _{tmax} =40VDC
	Non-repetitive peak voltage	U_{tp}	75V	
	Overvoltage protection	D1	39V (Transient voltage suppressor)	1500W / 1ms See fig.10 & 11
	Off-state max reverse voltage drop (internal diode)	-U_t	0.92V	@I _e =75A & @U _c =0 See fig. 6
	Maximum nominal currents	I_{e max}	Resistive 60A	Motor Please contact us
	Max. non-repetitive peak current	I_{epeak}	Switch OFF D<1% 294A	Switch OFF F _{max} 60A
				ON-state 750A
	Min. load current	I_{emin}	5mA	
	Max. leakage current	I_{elk max}	3mA	@U _{tmax} @T _{jmax}
	Max. on-state resistance	RD_{son}	4.5mOhms @T _j =25°C	8.2mOhms @T _j =125°C
	Typ. output capacitance	C_{out}	1.5nF	@U _{tp}
	Junction/case thermal resistance per power element	R_{thjc}	1.2K/W	
	Built-in heatsink thermal resistance vertically mounted	R_{thra}	10K/W	@ΔT _{ra} =75°C
	Heatsink thermal time constant	T_{thra}	10 minutes	@ΔT _{ra} =60°C
	Control inputs/power outputs insulation voltage	U_{imp}	2.5kV	
	Inputs/case insulation voltage	U_{imp}	2.5kV	
	Outputs/case insulation voltage	U_{imp}	2.5kV	
	Isolation resistance	R_{io}	1GΩ	
	Isolation capacitance	C_{io}	<8pF	
	Maximum junction temperature	T_{jmax}	175°C	
	Storage ambient temperature	T_{stg}	-40->+100°C	
	Operating ambient temperature	T_{amb}	-25->+90°C	See fig. 9
	Max. case temperature	T_c	100°C	

OUTPUT SWITCH CHARACTERISTIC CURVES

Fig. 5 ON RESISTANCE VS JUNCTION TEMPERATURE

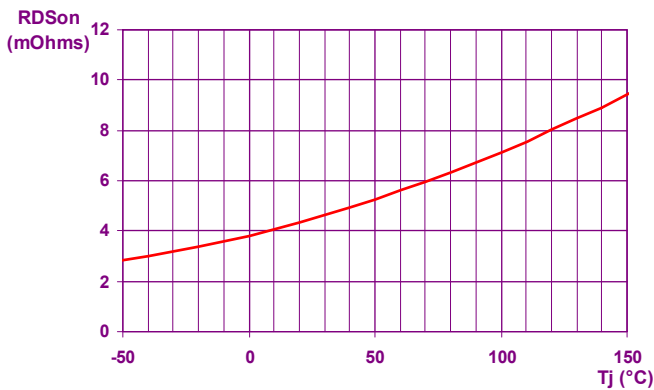

Fig. 6 REVERSE VOLTAGE DROP VS REVERSE CURRENT

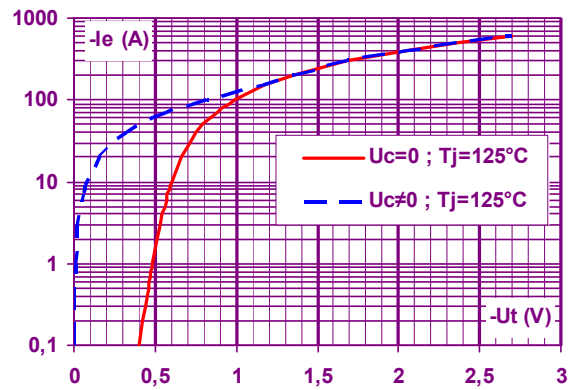

Fig. 7 POWER ELEMENT TRANSIENT THERMAL IMPEDANCE vs. PULSE DURATION

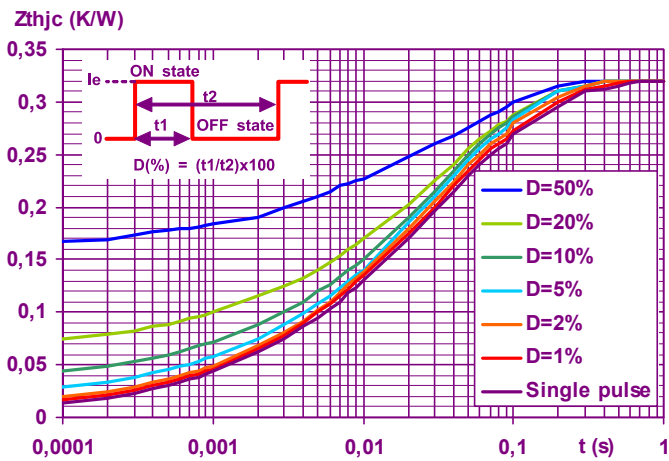

Fig. 8 ON-STATE PEAK OVERLOAD CURRENT vs. PULSE DURATION

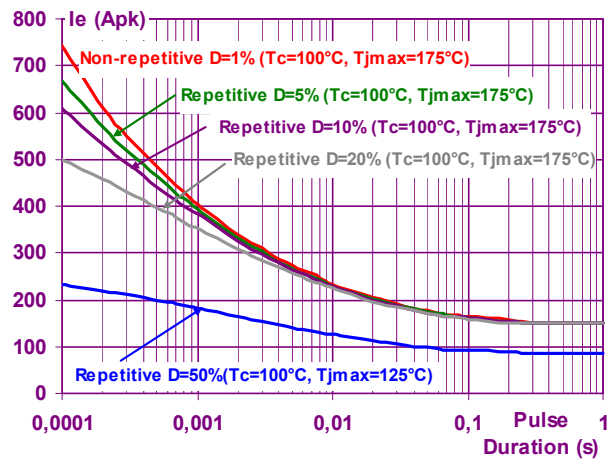
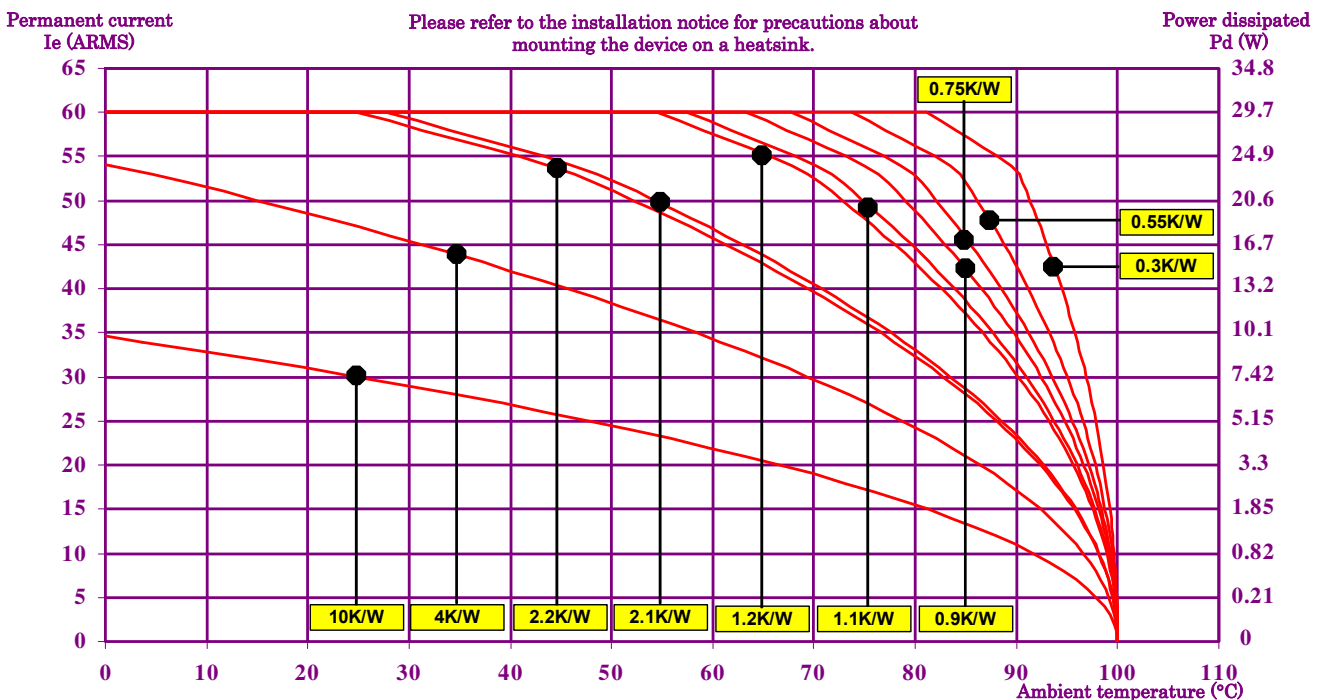

Fig. 9 POWER DISSIPATED AND LOAD CURRENT LIMIT VS TEMPERATURE



10K/W = No Heatsink / 1LD12020
2.1K/W = WF210000
0.9K/W = WF115100

4K/W = 150x150x3mm aluminium sheet
1.2K/W = WF121000
0.75K/W = WF070000

2.2K/W = WF262100 / WF151200
1.1K/W = WF131100
0.55K/W = WF050000

0.3K/W = WF031100

BUILT-IN OVERVOLTAGE PROTECTION CHARACTERISTICS

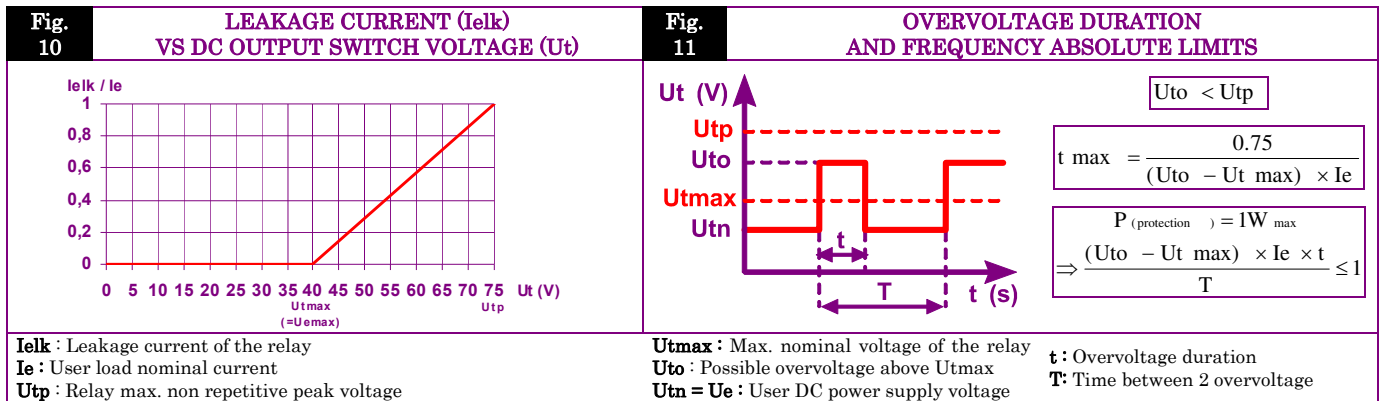

GENERAL INFORMATION

MISC.	Display		Green LED (indicates relay has switched ON)	
	Housing		UL94V0	
	Mounting		2 screws (M4x12mm ; tightening = 1.2N.m)	See mounting sheet
	Noise level		None	
	Weight		80g	

STANDARDS

GENERAL	Standards		IEC60947-1	
	Protection level		IP20	
	Protection against direct touch		Yes	
	CE marking		Yes	
	UL, cULUS		Yes	

E.M.C. IMMUNITY	TYPE OF TEST	STANDARD	LEVEL	EFFECT
	Fast transients bursts	EN61000-4-4	4kV criterion B	
	Electric chocks	EN61000-4-5	1kV criterion B	
	Voltage drop	EN61000-4-11	-	





CONNECTIONS



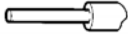

Direct connection with wires with or without ferrules



With ring terminals

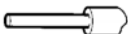

okpac [®]				Control wiring	
Number of wires				Screwdriver type	Recommended tightening torque M4 screw
1		2			
SOLID (No ferrule)	FINE STRANDED (With ferrule)	SOLID (No ferrule)	FINE STRANDED (With ferrule)		N.m
					
0,75 ... 2,5 mm ² AWG18...AWG14	0,75 ... 2,5 mm ² AWG18...AWG14	0,75 ... 2,5 mm ² AWG18...AWG14	0,75 ... 2,5 mm ² AWG18...AWG14	POZIDRIV 2	Mini 1,2 / Typ 1,5 / Max 2

okpac [®]				Power wiring	
Number of wires				Modèle de tournevis / Screwdriver type	Recommended tightening torque M5 screw
1		2			
SOLID (No ferrule)	FINE STRANDED (With ferrule)	SOLID (No ferrule)	FINE STRANDED (With ferrule)		N.m
					
1,5 ... 10 mm ² AWG16...AWG8	1,5 ... 6 mm ² AWG16...AWG10	1,5 ... 10 mm ² AWG16...AWG8	1,5 ... 6 mm ² AWG16...AWG10	POZIDRIV 2	Mini 2 / Typ 2,4 / Max 3

Power with ring terminals.

W max = 12,6mm

16 mm² (AWG6)

25 mm² (AWG4)

35mm² (AWG2 / AWG3)

50mm² (AWG0 / AWG1)

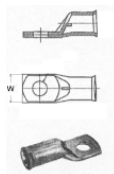

Suitable ring terminals and special kit for high current can be delivered: see high power SSR and data-sheet for power connection.

IP20 flaps

Flaps are delivered mounted on the relay.

Labels

Marking labels are available, for mounting on flaps.
Part number : 1MZ09000
(delivered per 200 parts)

FASTONS: Consult us



DIMENSIONS AND ACCESSORIES

Fig. 12

DIMENSIONS (mm)

CAD documents : www.celduc-relais.com/uk/plan3D.asp

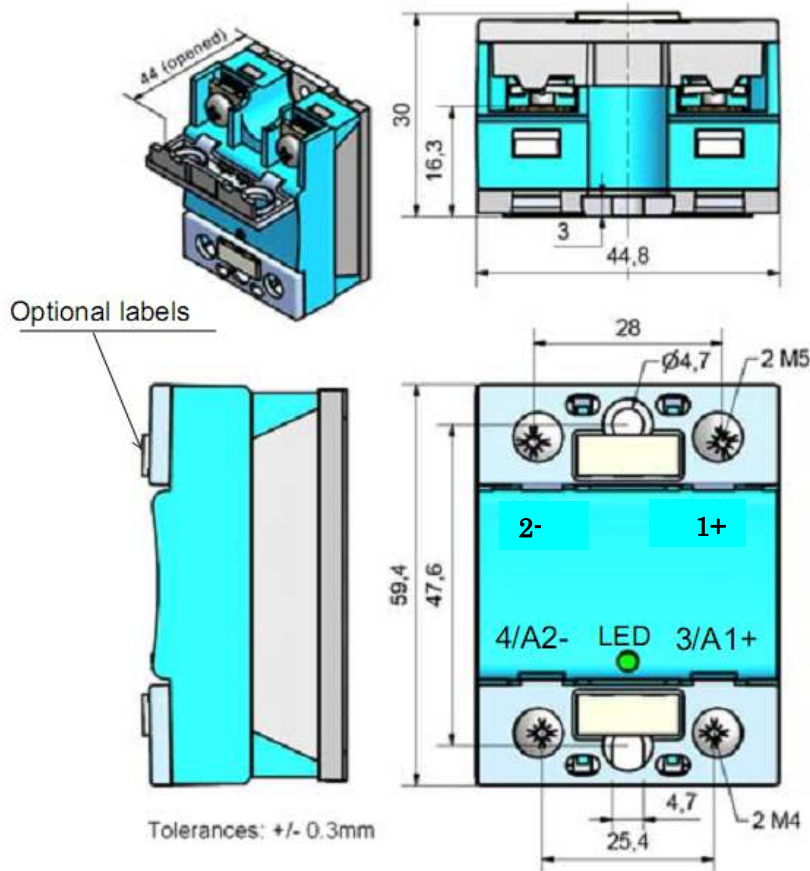

ACCESSORIES

**READY TO USE OVERVOLTAGE PROTECTION
ESO01000**

(Please check our website for availability)

This device includes a diode (D2) and a capacitor (C1) suitable for most of the DC application.

To be mounted close to the SOM.

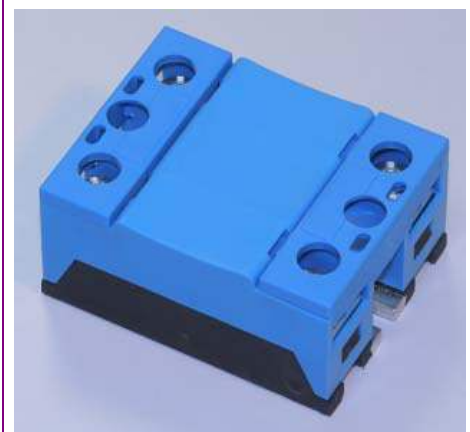

Please consult our website for other accessory references
(Heatsinks, mounting adaptors, thermal grease...)