

TL50H High Brightness Tower Light



Datasheet

Multi-Color General-Purpose or Audible Indicators



- Similar in design and construction to standard TL50 Tower Lights, but more than 4 times brighter, improving visibility in areas with high levels of ambient light
- Rugged, cost-effective, and easy-to-install multi-segment indicators
- Illuminated segments provide easy-to-see operator guidance and indication of equipment status
- Displays up to 5 colors
- Available in black or light gray housing
- Audible models available with standard, sealed, or omni-directional audible element
- Compact devices are completely self-contained, no controller needed
- 18 V dc to 30 V dc or 24 V ac operation
- No assembly required

Non-Audible Models

Model ¹	# of LED Colors	LED Colors ²	Connection ³	Inputs
TL50HRQ	1	Red	Integral 4-pin M12/Euro-style quick disconnect	Bimodal (NPN or PNP)
TL50HGRQ	2	Green, Red		
TL50HGYRQ	3	Green, Yellow, Red		
TL50HBGYRQ	4	Blue, Green, Yellow, Red	Integral 5-pin M12/Euro-style quick disconnect	
TL50HWBGRQ	5	White, Blue, Green, Yellow, Red	Integral 8-pin M12/Euro-style quick disconnect	

Audible Models

Standard Audible Model ¹	# of LED Colors	LED Colors ²	Connection ³	Inputs
TL50HRAQ	1	Red	Integral 4-pin M12/Euro-style quick disconnect	Bimodal (NPN or PNP)
TL50HGRAQ	2	Green, Red		
TL50HGYRAQ	3	Green, Yellow, Red	Integral 5-pin M12/Euro-style quick disconnect	
TL50HBGYRAQ	4	Blue, Green, Yellow, Red	Integral 8-pin M12/Euro-style quick disconnect	

Sealed Audible Model ¹			# of LED Colors	LED Colors ²	Connection ³	Inputs
Continuous	Pulsed at 1.6 Hz	Staccato				
TL50HRALSQ	TL50HRALS3Q	TL50HRALS4Q	1	Red	Integral 4-pin M12/Euro-style quick disconnect	Bimodal (NPN or PNP)
TL50HGRALSQ	TL50HGRALS3Q	TL50HGRALS4Q	2	Green, Red		
TL50HGYRALSQ	TL50HGYRALS3Q	TL50HGYRALS4Q	3	Green, Yellow, Red	Integral 5-pin M12/Euro-style quick disconnect	
TL50HBGYRALSQ	TL50HBGYRALS3Q	TL50HBGYRALS4Q	4	Blue, Green, Yellow, Red	Integral 8-pin M12/Euro-style quick disconnect	

Omni-Directional Sealed Audible Model ¹			# of LED Colors	LED Colors ²	Connection ³	Inputs
Continuous	Pulsed at 1.6 Hz	Staccato				
TL50HRAOSQ	TL50HRAOS3Q	TL50HRAOS4Q	1	Red	Integral 4-pin M12/Euro-style quick disconnect	Bimodal (NPN or PNP)
TL50HGRAOSQ	TL50HGRAOS3Q	TL50HGRAOS4Q	2	Green, Red		
TL50HGYRAOSQ	TL50HGYRAOS3Q	TL50HGYRAOS4Q	3	Green, Yellow, Red	Integral 5-pin M12/Euro-style quick disconnect	
TL50HBGYRAOSQ	TL50HBGYRAOS3Q	TL50HBGYRAOS4Q	4	Blue, Green, Yellow, Red	Integral 8-pin M12/Euro-style quick disconnect	

¹ Models with black housing are listed. For gray housing, add the suffix "C" at the end of the cabled model number or before the "QP" in 150 mm (6 in) PVC cable model numbers. For example, TL50HRC or TL50HRCQ.

² The first color listed is the bottom color, going up in successive order.

³ To order the 2 m (6.5 ft) PVC cable model, omit the suffix "Q" in the model number. For example, TL50HR.

To order the 150 mm (6 in) PVC cable model, replace the suffix "Q" with "QP" in the model number. For example, TL50HRQP.

Models with a quick disconnect require a mating cordset.



Omni-Directional Sealed Audible Model with Intensity Adjustment ¹			# of LED Colors	LED Colors ²	Connection ³	Inputs
Continuous	Pulsed at 1.6 Hz	Staccato				
TL50HRAOSIQ	TL50HRAOS3IQ	TL50HRAOS4IQ	1	Red	Integral 4-pin M12/Euro-style quick disconnect	Bimodal (NPN or PNP)
TL50HGRAOSIQ	TL50HGRAOS3IQ	TL50HGRAOS4IQ	2	Green, Red		
TL50HGYRAOSIQ	TL50HGYRAOS3IQ	TL50HGYRAOS4IQ	3	Green, Yellow, Red	Integral 5-pin M12/Euro-style quick disconnect	
TL50HBGYRAOSIQ	TL50HBGYRAOS3IQ	TL50HBGYRAOS4IQ	4	Blue, Green, Yellow, Red	Integral 8-pin M12/Euro-style quick disconnect	

Wiring Diagram — 4-Pin Models with 1 to 3 Segments

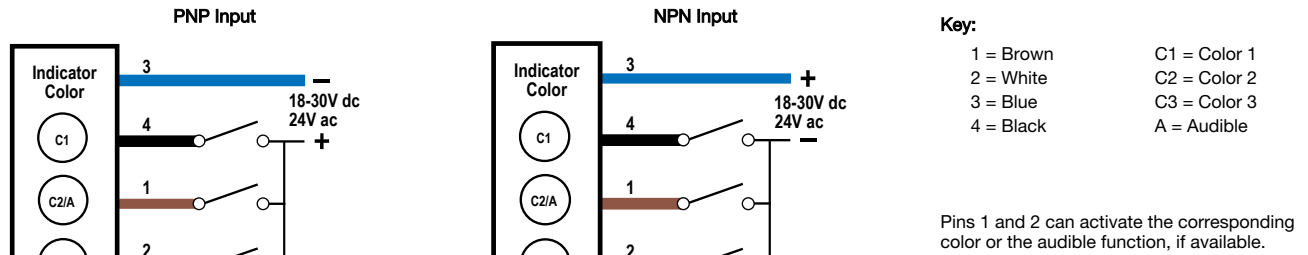

Wiring Diagram — 5-Pin Models with 4 Segments

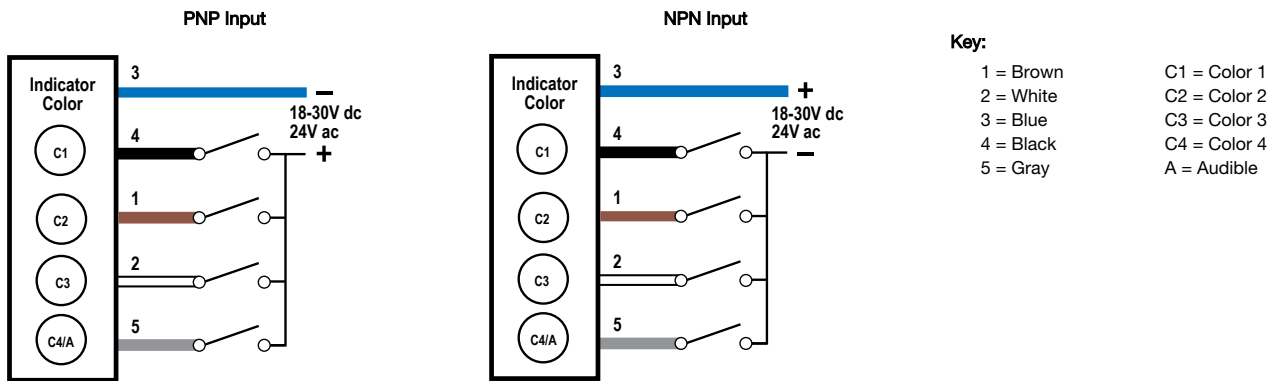

Wiring Diagram — 8-Pin Models with 5 Segments

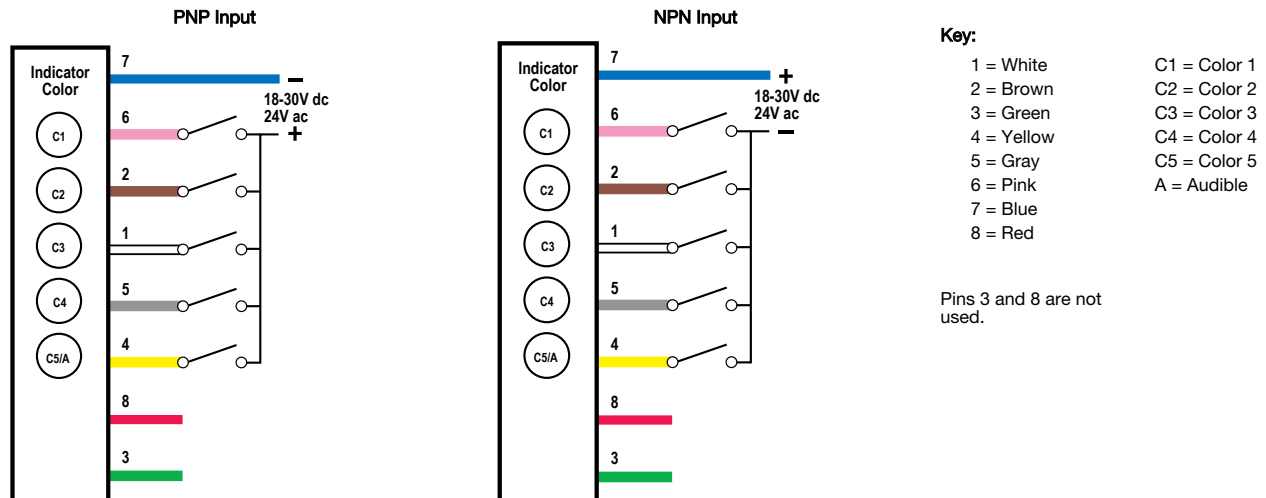

Specifications

Supply Voltage and Current

18 V dc to 30 V dc; or 24 V ac (± 3 V) at 50 Hz to 60 Hz

Indicators—maximum current per LED color:

- 100 mA at 18 V dc
- 60 mA at 30 V dc
- 75 mA at 24 V ac

Standard Audible Alarm: 25 mA maximum current

Sealed Audible Alarm: 35 mA maximum current

Omni-Directional Sealed Audible Alarm: 45 mA maximum current

Supply Protection Circuitry

Protected against transient voltages

Input Response Time

Indicator On/Off: 10 milliseconds maximum

Audible Alarm

Standard Audible Alarm: 2.7 kHz \pm 500 Hz oscillation frequency; maximum intensity 92 dB at 1 m (3.3 ft) (typical)

Sealed Audible Alarm: 2.9 kHz \pm 250 Hz oscillation frequency; maximum intensity 94 dB at 1 m (3.3 ft) (typical)

Omni-Directional Sealed Audible Alarm: 2.1 kHz \pm 250 Hz oscillation frequency; maximum intensity 99 dB at 1 m (3.3 ft) (typical)

Omni-Directional Sealed Audible Alarm with Intensity Adjustment: 2.1 kHz \pm 250 Hz oscillation frequency; maximum intensity 95 dB at 1 m (3.3 ft) (typical)

Typical Reduction in Sound Intensity with Audible Adjustment (maximum to minimum)

- **Standard Audible:** 30 dB
- **Sealed Audible:** 20 dB
- **Omni-Directional Sealed Audible:** 12 dB

Audible Adjustment

Standard Audible Alarm: Unscrew the cover (up to 1.5 turns maximum) to adjust the audible intensity. (Do not exceed 1.5 turns or the cover may detach during operation.) For maximum intensity, rotate the center plug 180° counterclockwise to remove it.

Sealed Audible Alarm and Omni-Directional Sealed Audible Alarm with Intensity Adjustment: Rotate the front cover until the desired intensity is reached.

Omni-Directional Sealed Audible Alarm: No adjustment.

Connections

Integral 4-pin, 5-pin, or 8-pin M12/Euro-style quick disconnect, 150 mm (6 in) PVC cable with a M12/Euro-style quick disconnect, or 2 m (6.5 ft) integral PVC cable, depending on model

Models with a quick disconnect require a mating cordset

Construction

Bases and Covers: ABS

Light Segment: Polycarbonate

Vibration and Mechanical Shock

Meets IEC 60068-2-6 requirements (Vibration: 10 Hz to 55 Hz, 1.0 mm amplitude, 5 minutes sweep, 30 minutes dwell)

Meets IEC 60068-2-27 requirements (Shock: 30G 11 ms duration, half sine wave)

Certifications



Indicators

LEDs are independently selected; 1 to 5 colors depending on model

Indicator Characteristics

Color	Dominant Wavelength (nm) or Color Temperature (CCT)	Lumen Output (Typical at 25 °C)
Green	525 nm	60
Red	625 nm	32
Yellow	590 nm	23
Blue	475 nm	23
White	5000 K	50

Operating Conditions

Non-Audible: -40 °C to +50 °C (-40 °F to +122 °F)

Standard and Sealed Audible: -20 °C to +50 °C (-4 °F to +122 °F)

95% at +50 °C maximum relative humidity (non-condensing)

Environmental Rating

UL Type 4X Indoor and UL Type 13

Non-Audible and Sealed Audible: IEC IP67

Standard Audible: IEC IP50

Required Overcurrent Protection



WARNING: Electrical connections must be made by qualified personnel in accordance with local and national electrical codes and regulations.

Overcurrent protection is required to be provided by end product application per the supplied table.

Overcurrent protection may be provided with external fusing or via Current Limiting, Class 2 Power Supply.

Supply wiring leads < 24 AWG shall not be spliced.

For additional product support, go to www.bannerengineering.com.

Supply Wiring (AWG)	Required Overcurrent Protection (Amps)
20	5.0
22	3.0
24	2.0
26	1.0
28	0.8
30	0.5

Dimensions

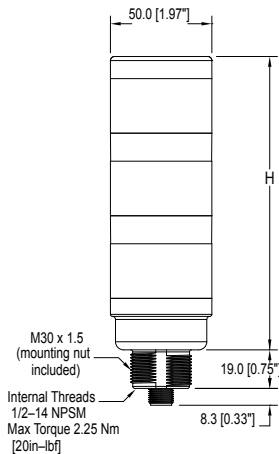

# of Colors	Tower Height (H)			
	Non-Audible	Standard Audible*	Sealed Audible	Omni-Directional Sealed Audible
1	61.2 mm (2.4 in)	92.0 mm (3.6 in)	115.1 mm (4.5 in)	129.1 mm (5.1 in)
2	101.9 mm (4.0 in)	132.7 mm (5.2 in)	155.8 mm (6.1 in)	169.8 mm (6.7 in)
3	142.6 mm (5.6 in)	173.4 mm (6.8 in)	196.5 mm (7.7 in)	210.5 mm (8.3 in)
4	183.3 mm (7.2 in)	214.1 mm (8.4 in)	237.2 mm (9.3 in)	251.2 mm (9.9 in)
5	224.0 mm (8.8 in)	-	-	-

* Tower height (H) with top unscrewed approximately 3.5 mm (0.18 in) to allow sound to escape

All measurements are listed in millimeters [inches], unless noted otherwise.

Accessories

Cordsets

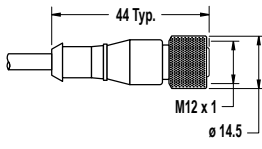
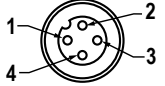
4-Pin Threaded M12/Euro-Style Cordsets—Single Ended				
Model	Length	Style	Dimensions	Pinout (Female)
MQDC-406	1.83 m (6 ft)	Straight		 <p>1 = Brown 2 = White 3 = Blue 4 = Black</p>
MQDC-415	4.57 m (15 ft)			
MQDC-430	9.14 m (30 ft)			
MQDC-450	15.2 m (50 ft)			

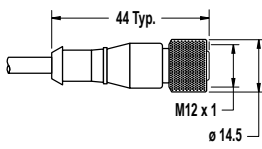
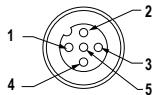
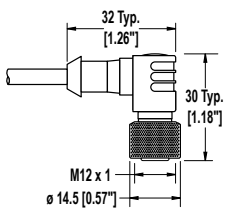
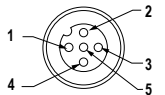
5-Pin Threaded M12/Euro-Style Cordsets—Single Ended				
Model	Length	Style	Dimensions	Pinout (Female)
MQDC1-501.5	0.50 m (1.5 ft)	Straight		 <p>1 = Brown 2 = White 3 = Blue 4 = Black 5 = Gray</p>
MQDC1-506	1.83 m (6 ft)			
MQDC1-515	4.57 m (15 ft)			
MQDC1-530	9.14 m (30 ft)			
MQDC1-506RA	1.83 m (6 ft)	Right-Angle		 <p>1 = Brown 2 = White 3 = Blue 4 = Black 5 = Gray</p>
MQDC1-515RA	4.57 m (15 ft)			
MQDC1-530RA	9.14 m (30 ft)			

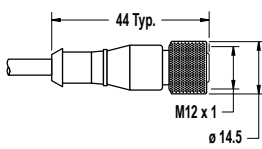
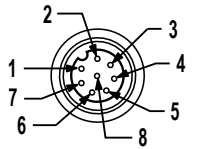
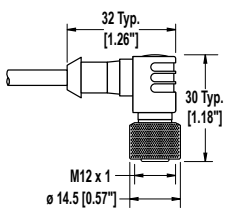
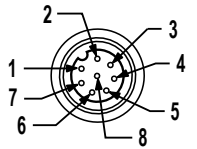
8-Pin Threaded M12/Euro-Style Cordsets with Open-Shield				
Model	Length	Style	Dimensions	Pinout (Female)
MQDC2S-806	1.83 m (6 ft)	Straight		 <p>1 = White 2 = Brown 3 = Green 4 = Yellow 5 = Gray 6 = Pink 7 = Blue 8 = Red</p>
MQDC2S-815	4.57 m (15 ft)			
MQDC2S-830	9.14 m (30 ft)			
MQDC2S-850	15.2 m (50 ft)			
MQDC2S-806RA	1.83 m (6 ft)	Right-Angle		 <p>1 = White 2 = Brown 3 = Green 4 = Yellow 5 = Gray 6 = Pink 7 = Blue 8 = Red</p>
MQDC2S-815RA	4.57 m (15 ft)			
MQDC2S-830RA	9.14 m (30 ft)			
MQDC2S-850RA	15.2 m (50 ft)			

Mounting Brackets

All measurements are listed in millimeters [inches], unless noted otherwise.

SMB30A

- Right-angle bracket with curved slot for versatile orientation
- Clearance for M6 (¼ in) hardware
- Mounting hole for 30 mm sensor
- 12-ga. stainless steel

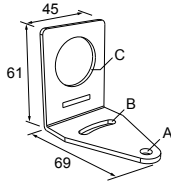

Hole center spacing: A to B=40
Hole size: A=ø 6.3, B= 27.1 x 6.3, C=ø 30.5

SMB30FA

- Swivel bracket with tilt and pan movement for precise adjustment
- Mounting hole for 30 mm sensor
- 12-ga. 304 stainless steel
- Easy sensor mounting to extrude rail T-slot
- Metric and inch size bolt available

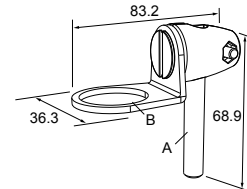

Bolt thread: SMB30FA, A= 3/8 - 16 x 2 in; SMB30FAM10, A= M10 - 1.5 x 50
Hole size: B=ø 30.1

SMB30MM

- 12-ga. stainless steel bracket with curved mounting slots for versatile orientation
- Clearance for M6 (¼ in) hardware
- Mounting hole for 30 mm sensor

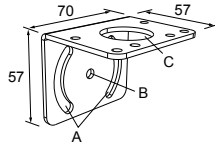

Hole center spacing: A= 51, A to B= 25.4
Hole size: A= 42.6 x 7, B= ø 6.4, C= ø 31.0

SMBAMS30P

- Flat SMBAMS series bracket
- 30 mm hole for mounting sensors
- Articulation slots for 90°+ rotation
- 12-ga. 300 series stainless steel

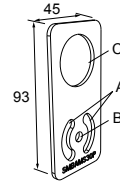

Hole center spacing: A=26.0, A to B=13.0
Hole size: A=26.8 x 7.0, B=ø 6.5, C=ø 31.0

SMBAMS30RA

- Right-angle SMBAMS series bracket
- 30 mm hole for mounting sensors
- Articulation slots for 90°+ rotation
- 12-ga. (2.6 mm) cold-rolled steel

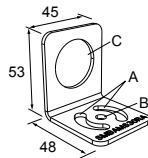

Hole center spacing: A=26.0, A to B=13.0
Hole size: A=26.8 x 7.0, B=ø 6.5, C=ø 31.0

SMB30SC

- Swivel bracket with 30 mm mounting hole for sensor
- Black reinforced thermoplastic polyester
- Stainless steel mounting and swivel locking hardware included

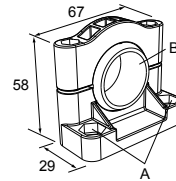

Hole center spacing: A=ø 50.8
Hole size: A=ø 7.0, B=ø 30.0

LMBE12RA35

- Direct mounting of stand-off pipe, with common bracket type
- Zinc-plated steel
- 1/2-14 NPSM nut
- Mounting distance from the wall to the center of the 1/2-14 NPSM nut is 35 mm

Hole center spacing: 20.0

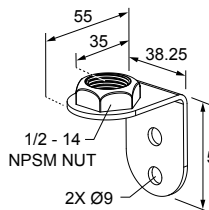

LMBE12RA45

- Direct mounting of stand-off pipe, with common bracket type
- Zinc-plated steel
- 1/2-14 NPSM nut
- Mounting distance from the wall to the center of the 1/2-14 NPSM nut is 45 mm

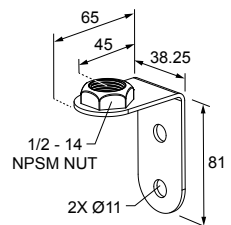

Hole center spacing: 35.0



LMB Sealed Right-Angle Bracket

Model	Description	Construction	
LMB30RA	Direct-Mount Models: Bracket kit with base, 30 mm adapter, set screw, fasteners, O-rings, and gaskets.	Black polycarbonate	
LMB30RAC		Gray polycarbonate	
LMBE12RA	Pipe-Mount Models: Bracket kit with base, ½-14 pipe adapter, set screw, fasteners, O-rings, and gaskets. For use with stand-off pipe (listed and sold separately).	Black polycarbonate	
LMBE12RAC		Gray polycarbonate	

Elevated Mount System

Model			Features	Components
SA-M30TE12 - Black Acetal			<ul style="list-style-type: none"> Streamlined black acetal or white UHMW stand-off pipe adapter/cover Connects between 30 mm light base and ½ in. NPSM/DN15 pipe Mounting hardware included 	
SA-M30TE12C - White UHMW				
Polished 304 Stainless Steel	Black Anodized Aluminum	Clear Anodized Aluminum	<ul style="list-style-type: none"> Elevated-use stand-off pipe (½ in. NPSM/DN15) Polished 304 stainless steel, black anodized aluminum, or clear anodized aluminum surface ½ in. NPT thread at both ends Compatible with most industrial environments 	
SOP-E12-150SS 150 mm (6 in) long	SOP-E12-150A 150 mm (6 in) long	SOP-E12-150AC 150 mm (6 in) long		
SOP-E12-300SS 300 mm (12 in) long	SOP-E12-300A 300 mm (12 in) long	SOP-E12-300AC 300 mm (12 in) long		
SOP-E12-900SS 900 mm (36 in) long	SOP-E12-900A 900 mm (36 in) long	SOP-E12-900AC 900 mm (36 in) long		
SA-E12M30 - Black Acetal			<ul style="list-style-type: none"> Streamlined black acetal or white UHMW mounting base adapter/cover Connects between ½ in. NPSM/DN15 pipe and 30 mm (1-3/16 in) drilled hole Mounting hardware included 	
SA-E12M30C - White UHMW				

Pipe Mounting Flange

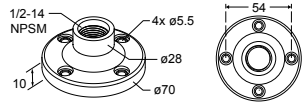
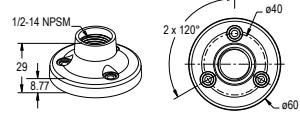
Pipe Mounting Flange			
Model	Features	Construction	
SA-F12	<ul style="list-style-type: none"> Elevated-use stand-off pipes (½ in, NPSM/DN15) M5 mounting hardware and nitrile gasket included 	Die-cast zinc base with black paint	
SA-F12-3	<ul style="list-style-type: none"> Elevated-use stand-off pipes (½ in, NPSM/DN15) M4 mounting hardware and nitrile blend gasket included 	Black Polycarbonate	

Banner Engineering Corp. Limited Warranty

Banner Engineering Corp. warrants its products to be free from defects in material and workmanship for one year following the date of shipment. Banner Engineering Corp. will repair or replace, free of charge, any product of its manufacture which, at the time it is returned to the factory, is found to have been defective during the warranty period. This warranty does not cover damage or liability for misuse, abuse, or the improper application or installation of the Banner product.

THIS LIMITED WARRANTY IS EXCLUSIVE AND IN LIEU OF ALL OTHER WARRANTIES WHETHER EXPRESS OR IMPLIED (INCLUDING, WITHOUT LIMITATION, ANY WARRANTY OF MERCHANTABILITY OR FITNESS FOR A PARTICULAR PURPOSE), AND WHETHER ARISING UNDER COURSE OF PERFORMANCE, COURSE OF DEALING OR TRADE USAGE.

This Warranty is exclusive and limited to repair or, at the discretion of Banner Engineering Corp., replacement. **IN NO EVENT SHALL BANNER ENGINEERING CORP. BE LIABLE TO BUYER OR ANY OTHER PERSON OR ENTITY FOR ANY EXTRA COSTS, EXPENSES, LOSSES, LOSS OF PROFITS, OR ANY INCIDENTAL, CONSEQUENTIAL OR SPECIAL DAMAGES RESULTING FROM ANY PRODUCT DEFECT OR FROM THE USE OR INABILITY TO USE THE PRODUCT, WHETHER ARISING IN CONTRACT OR WARRANTY, STATUTE, TORT, STRICT LIABILITY, NEGLIGENCE, OR OTHERWISE.**

Banner Engineering Corp. reserves the right to change, modify or improve the design of the product without assuming any obligations or liabilities relating to any product previously manufactured by Banner Engineering Corp. Any misuse, abuse, or improper application or installation of this product or use of the product for personal protection applications when the product is identified as not intended for such purposes will void the product warranty. Any modifications to this product without prior express approval by Banner Engineering Corp will void the product warranties. All specifications published in this document are subject to change; Banner reserves the right to modify product specifications or update documentation at any time. Specifications and product information in English supersede that which is provided in any other language. For the most recent version of any documentation, refer to: www.bannerengineering.com.

For patent information, see www.bannerengineering.com/patents.