



American Opto Plus LED Corp.

CTD591E-W/W

15.0 x 15.0 x 11.0 mm Touch LED Red Display

PACKAGE DIMENSION

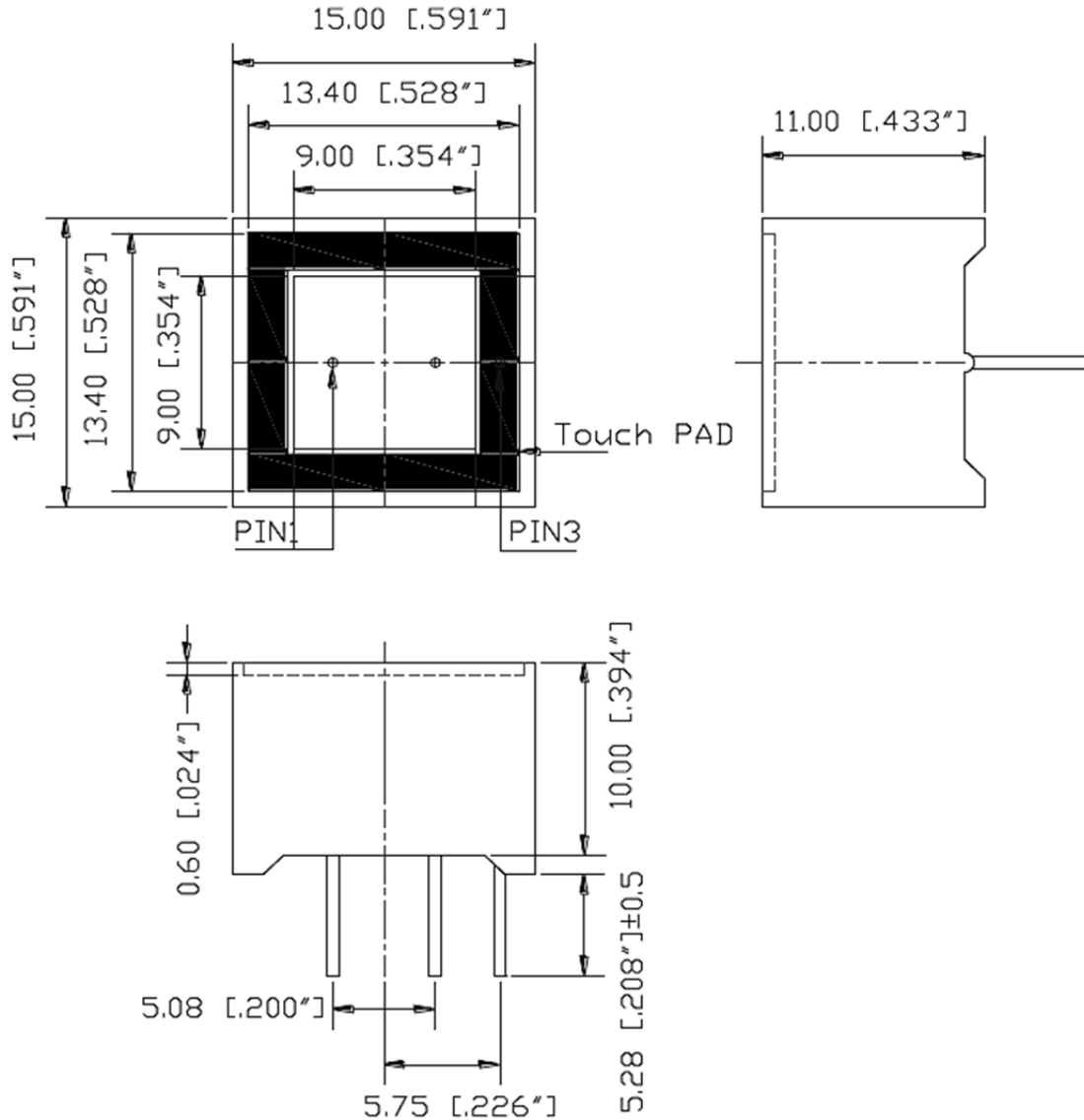

Notes:

1. All pins are $\Phi 0.60[0.24]$, dimensions in millimeter.
2. Tolerances are $\pm 0.25[0.01]$ unless otherwise noted.

Chip Material	Color	
	Emitter	Face/Segment
AlGaInP	Red	White/ White



American Opto Plus LED Corp.

CTD591E-W/W

15.0 x 15.0 x 11.0 mm Touch LED Red Display

PIN POSITION & INTERNAL CIRCUIT DIAGRAM

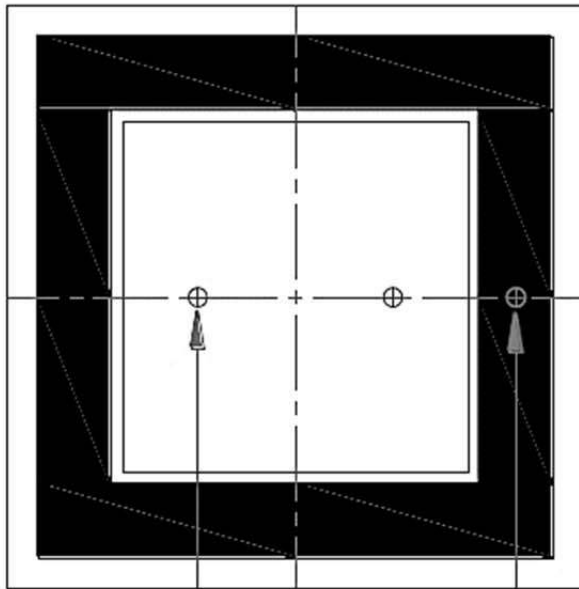

PIN1

PIN3

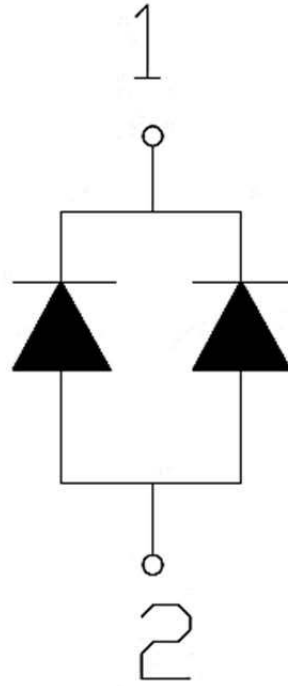

Touch PAD





American Opto Plus LED Corp.

CTD591E-W/W

15.0 x 15.0 x 11.0 mm Touch LED Red Display

ABSOLUTE MAXIMUM RATINGS

(Ta=25°C)

Parameter	Symbol	Value	Unit
Power Dissipation Per Dice	P_D	70	mW
Derating Liner from 25°C Per Dice	--	0.33	mA/°C
Continuous Forward Current Per Dice	I_F	25	mA
Peak Current Per Dice (duty cycle 1/10, 1KHz)	I_{FP}	90	mA
Reverse Voltage Per Dice	V_R	5	V
Operating Temperature Range	T_{OPR}	-35~+85	°C
Storage Temperature Range	T_{STG}	-35~+85	°C

OPTICAL-ELECTRICAL CHARACTERISTICS

(Ta=25°C)

Parameter	Symbol	Test Condition	Value			Unit
			Min	Typ	Max	
Forward Voltage	V_F	$I_F=20mA$	--	2.0	2.8	V
Luminous Intensity	I_V		44	78	--	mcd
Peak Emission Wavelength	λ_P		--	632	--	nm
Dominant Wavelength	λ_D		--	625	--	nm
Spectrum Radiation Bandwidth	$\Delta\lambda$		--	20	--	nm
Luminous Intensity Matching Ratio	I_V-m	$I_F=10mA$	--	--	2:1	--
Reverse Current	I_R	$V_R=5V$	--	--	100	μA

Forward voltage tolerance: $\pm 0.1V$

Luminous intensity tolerance: $\pm 20\%$



American Opto Plus LED Corp.

CTD591E-W/W

15.0 x 15.0 x 11.0 mm Touch LED Red Display

LUMINOUS INTENSITY BIN GRADE

($I_F=20\text{mA}$)

N	P	Q
44.096	70.555	112.889
I	I	I
70.554	112.888	180.622



American Opto Plus LED Corp.

CTD591E-W/W

15.0 x 15.0 x 11.0 mm Touch LED Red Display

OPTICAL CHARACTERISTIC CURVES

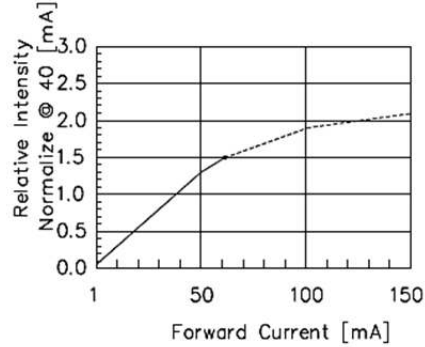
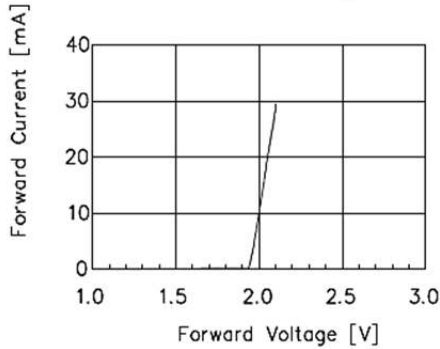

Fig 1. Forward Current vs. Forward Voltage(One chip) Fig 2. Relative Intensity vs. Forward Current

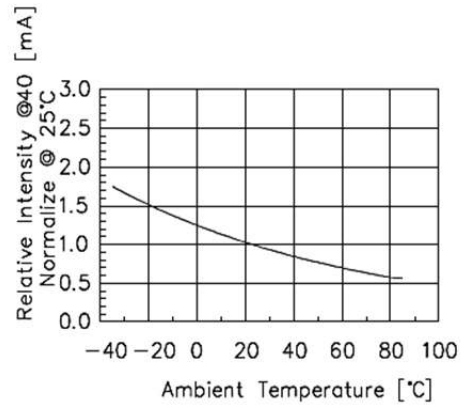
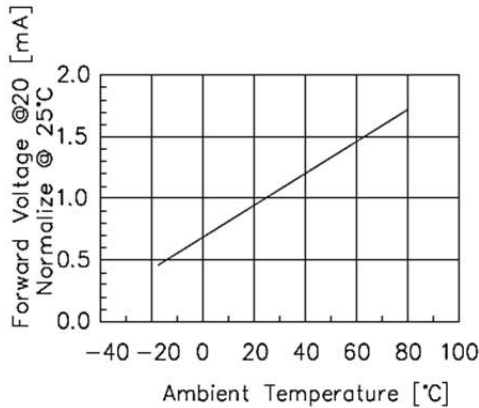

Fig 3. Forward Voltage vs. Temperature(One chip) Fig 4. Relative Intensity vs. Temperature

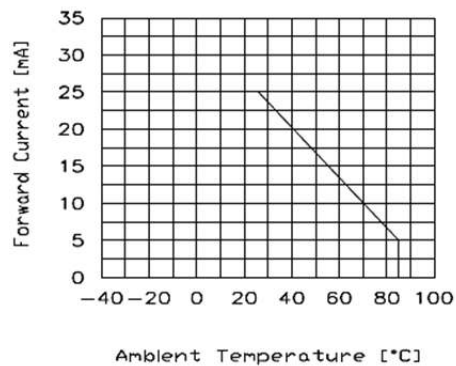
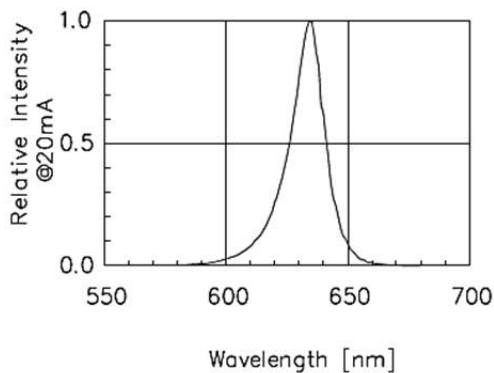

Fig 5. Relative Intensity vs. Wavelength(One chip) Fig 6. Maximum allowable DC current per segment vs. A function of ambient temperature(One chip)



American Opto Plus LED Corp.

CTD591E-W/W

15.0 x 15.0 x 11.0 mm Touch LED Red Display

SOLDERING CONDITIONS

1. Wave Soldering Profile

Distance: 1.6mm min (From Seating Plane)

Item	Condition		Note
Preheat	Temperature T1	80 – 120 °C	PWB Temperature (Soldering Side Surface)
	Time t1	60 – 180sec	
Solder Dip	Temperature T2	230 – 260°C	Bath Temperature
	Time t2	2 – 4 sec	Solder Tank Passage Time

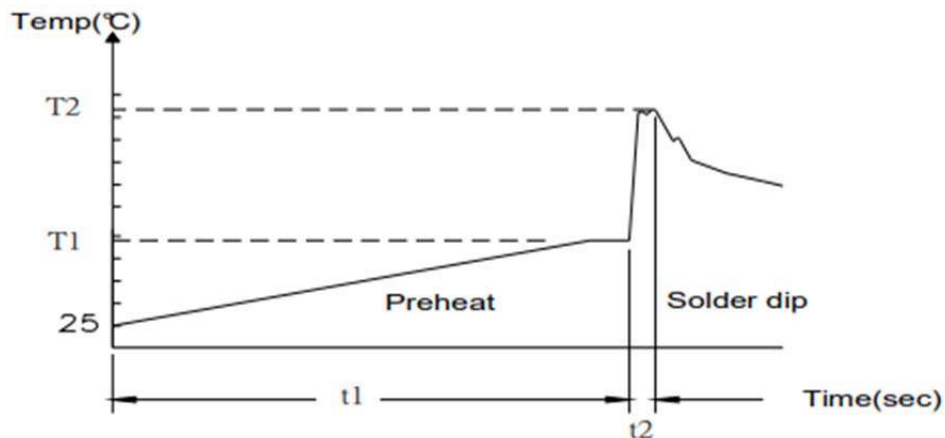

2. Hand Soldering (Iron Condition)

Soldering Iron: 30W Max

Temperature 350°C Max

Soldering Time: 3 Seconds Max (One Time)

Distance: 1.6mm min (From Seating Plane)



American Opto Plus LED Corp.

CTD591E-W/W

15.0 x 15.0 x 11.0 mm Touch LED Red Display

PACKAGE SPECIFICATION

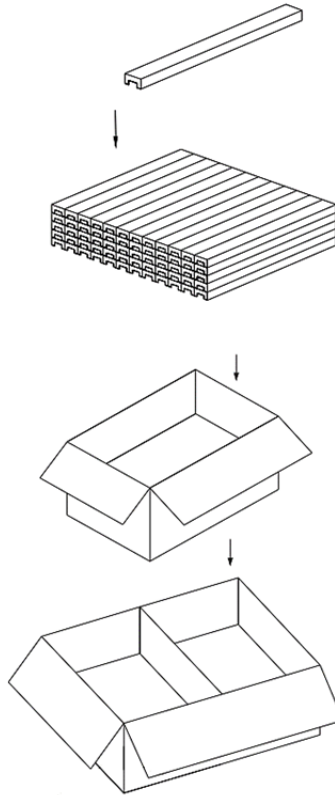

Package	Size	Unit	Amount	Unit	Amount	Unit	Note
TUBE	L300*W190*H20	mm	1	TUBE	10	Pcs	--
Inner Box	L305*W205*H240	mm	187	TUBE	1870	Pcs	17*11=187
Outer Box	L430*W330*H270	mm	2	Inner Box	3740	Pcs	--

STORAGE METHOD

1. Product cannot be placed on the location of direct sunlight.
2. Product storage environment: Temp. -35°C~85°C, RH 45%~85%.
3. After unpacking the product be use within 1 year.
4. After unpacking, do not take anything up in order to avoid PIN shifting.