

# TUSB546-DCI USB Type-C™ DP ALT Mode Linear Redriver Crosspoint Switch

## 1 Features

- USB Type-C crosspoint switch supporting:
  - USB 3.1 SS + 2 DP Lanes
  - 4 DP Lanes
- USB 3.1 Gen1 up to 5 Gbps
- DisplayPort 1.4 up to 8.1 Gbps (HBR3)
- VESA DisplayPort alt mode DFP redriving crosspoint switch supporting c, d, e and f configurations
- Ultra-low-power architecture
- Linear redriver with up to 14 dB equalization
- Transparent to DisplayPort link training
- Automatic LFPS de-emphasis control to meet USB 3.1 certification requirements
- Configuration through GPIO or I<sup>2</sup>C
- Hot-plug capable
- Industrial temperature range: -40°C to 85°C (TUSB546I-DCI)
- Commercial temperature range: 0°C to 70°C (TUSB546-DCI)
- 4 mm × 6 mm, 0.4 mm Pitch WQFN package

## 2 Applications

- [Tablets](#)
- [Notebooks](#)
- [Desktops](#)
- [Docking stations](#)

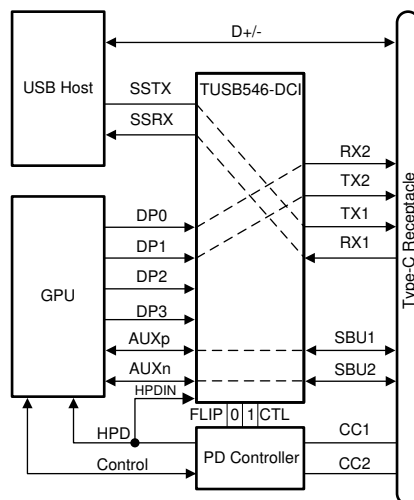

Copyright © 2016, Texas Instruments Incorporated

### Simplified Schematics

## 3 Description

The TUSB546-DCI is a VESA USB Type-C™ Alt Mode redriving switch supporting USB 3.1 data rates up to 5 Gbps and DisplayPort 1.4 up to 8.1 Gbps for downstream facing port (Host). The device is used for configurations C, D, E, and F from the VESA DisplayPort Alt Mode on USB Type-C Standard Version 1.1. This protocol-agnostic linear redriver is also capable of supporting other USB Type-C Alt Mode interfaces.

The TUSB546-DCI provides several levels of receive linear equalization to compensate for cable and board trace loss due to inter symbol interference (ISI). Operates on a single 3.3 V supply and comes in a commercial temperature range and industrial temperature range.

### Package Information<sup>(1)</sup>

PART NUMBER	PACKAGE	BODY SIZE (NOM)
TUSB546-DCI	RNQ (WQFN, 40)	4.00 mm × 6.00 mm
TUSB546I-DCI		

- (1) For all available packages, see the orderable addendum at the end of the data sheet.



TUSB546-DCI Eye Diagram



## Table of Contents

<b>1 Features</b> .....	1	7.3 Feature Description.....	16
<b>2 Applications</b> .....	1	7.4 Device Functional Modes.....	17
<b>3 Description</b> .....	1	7.5 Programming.....	22
<b>4 Revision History</b> .....	2	7.6 Register Maps.....	24
<b>5 Pin Configuration and Functions</b> .....	3	<b>8 Application and Implementation</b> .....	29
<b>6 Specifications</b> .....	5	8.1 Application Information.....	29
6.1 Absolute Maximum Ratings.....	5	8.2 Typical Application.....	29
6.2 ESD Ratings.....	5	8.3 System Examples.....	33
6.3 Recommended Operating Conditions.....	5	8.4 Power Supply Recommendations.....	37
6.4 Thermal Information.....	5	8.5 Layout.....	37
6.5 Power Supply Characteristics.....	6	<b>9 Device and Documentation Support</b> .....	39
6.6 DC Electrical Characteristics.....	6	9.1 Receiving Notification of Documentation Updates.....	39
6.7 AC Electrical Characteristics.....	7	9.2 Support Resources.....	39
6.8 Timing Requirements.....	8	9.3 Trademarks.....	39
6.9 Switching Characteristics.....	9	9.4 Electrostatic Discharge Caution.....	39
6.10 Typical Characteristics.....	10	9.5 Glossary.....	39
<b>7 Detailed Description</b> .....	14	<b>10 Mechanical, Packaging, and Orderable Information</b> .....	39
7.1 Overview.....	14		
7.2 Functional Block Diagram.....	15		

## 4 Revision History

NOTE: Page numbers for previous revisions may differ from page numbers in the current version.

<b>Changes from Revision D (May 2019) to Revision E (March 2023)</b>	<b>Page</b>
• Updated the numbering format for tables, figures, and cross-references throughout the document.....	1
• Added inclusive terminology throughout the data sheet.....	1
<b>Changes from Revision C (April 2018) to Revision D (May 2019)</b>	<b>Page</b>
• Added following to pin 11 description: If I2C_EN = “F”, then this pin must be set to “F” or “0”. .....	3
<b>Changes from Revision B (June 2017) to Revision C (April 2018)</b>	<b>Page</b>
• Changed the appearance of the pinout image in the <i>Pin Configuration and Function</i> section.....	3
• Added Note 1 to the <i>Pin Functions</i> table.....	3
• Changed the USB3.1 Control/Status Registers reset value From: 00000000 To: 00000100.....	28
• Changed the Reset value of bit 3:2 From: 00 To: 01 in <a href="#">Table 7-18</a> .....	28
<b>Changes from Revision A (April 2017) to Revision B (June 2017)</b>	<b>Page</b>
• Changed the Human-body model (HBM) value From: ±6000 V To: ±5000 in the <i>ESD Ratings</i> .....	5
<b>Changes from Revision * (August 2016) to Revision A (April 2017)</b>	<b>Page</b>
• Changed title of <a href="#">Figure 6-2</a> From: USB TX EQ Settings Curves To: USB RX EQ Settings Curves.....	10
• Changed title of <a href="#">Figure 6-3</a> From: USB RX EQ Settings Curves To: USB TX EQ Settings Curves.....	10

## 5 Pin Configuration and Functions

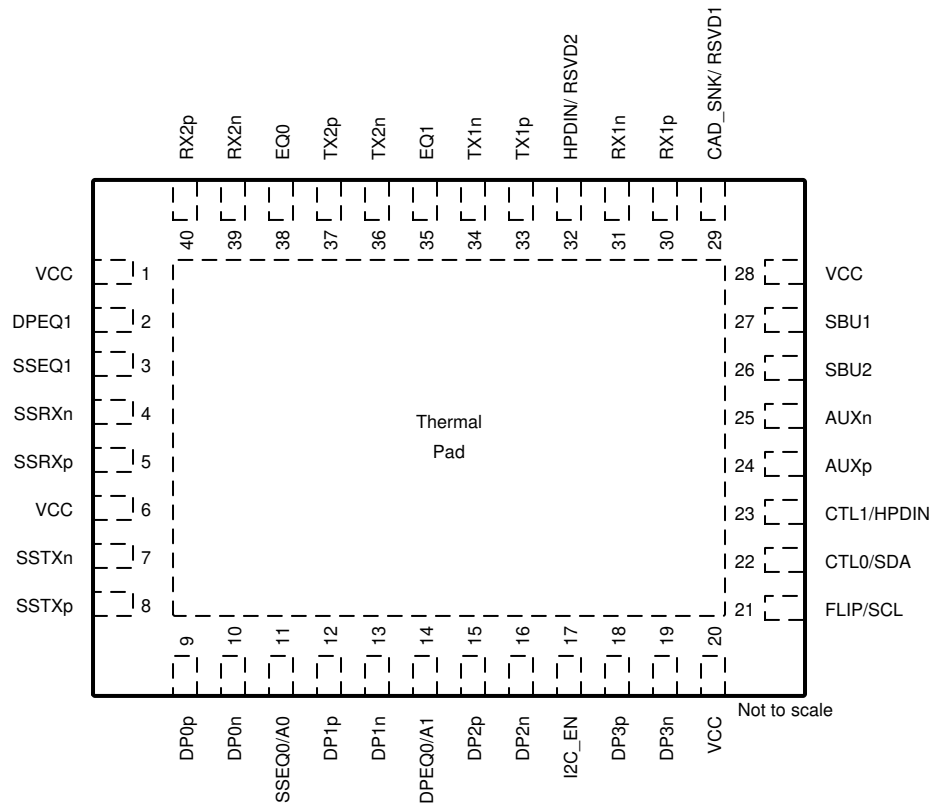

Figure 5-1. RNQ Package, 40-Pin WQFN (Top View)

Table 5-1. Pin Functions

PIN		I/O	DESCRIPTION
NAME	NO.		
DP0p	9	Diff I	DP Differential positive input for DisplayPort Lane 0.
DP0n	10	Diff I	DP Differential negative input for DisplayPort Lane 0.
DP1p	12	Diff I	DP Differential positive input for DisplayPort Lane 1.
DP1n	13	Diff I	DP Differential negative input for DisplayPort Lane 1.
DP2p	15	Diff I	DP Differential positive input for DisplayPort Lane 2.
DP2n	16	Diff I	DP Differential negative input for DisplayPort Lane 2.
DP3p	18	Diff I	DP Differential positive input for DisplayPort Lane 3.
DP3n	19	Diff I	DP Differential negative input for DisplayPort Lane 3.
RX1n	31	Diff I/O	Differential negative output for DisplayPort or differential negative input for USB3.1 Downstream Facing port.
RX1p	30	Diff I/O	Differential positive output for DisplayPort or differential positive input for USB3.1 Downstream Facing port.
TX1n	34	Diff O	Differential negative output for DisplayPort or USB3.1 downstream facing port.
TX1p	33	Diff O	Differential positive output for DisplayPort or USB 3.1 downstream facing port.
TX2p	37	Diff O	Differential positive output for DisplayPort or USB 3.1 downstream facing port.
TX2n	36	Diff O	Differential negative output for DisplayPort or USB 3.1 downstream facing port.
RX2p	40	Diff I/O	Differential positive output for DisplayPort or differential positive input for USB3.1 Downstream Facing port.
RX2n	39	Diff I/O	Differential negative output for DisplayPort or differential negative input for USB3.1 Downstream Facing port.
SSTXp	8	Diff I	Differential positive input for USB3.1 upstream facing port.
SSTXn	7	Diff I	Differential negative input for USB3.1 upstream facing port.

**Table 5-1. Pin Functions (continued)**

PIN		I/O	DESCRIPTION
NAME	NO.		
SSRXp	5	Diff O	Differential positive output for USB3.1 upstream facing port.
SSRXn	4	Diff O	Differential negative output for USB3.1 upstream facing port.
EQ1	35	4 Level I	This pin along with EQ0 sets the USB receiver equalizer gain for downstream facing RX1 and RX2 when USB used. Up to 11dB of EQ available.
EQ0	38	4 Level I	This pin along with EQ1 sets the USB receiver equalizer gain for downstream facing RX1 and RX2 when USB used. Up to 11 dB of EQ available.
CAD_SNK/ RSVD1 <sup>(1)</sup>	29	I/O (PD)	When I2C_EN != 0, this pin is reserved. Leave open if not used. When I2C_EN = 0, this pin is CAD_SNK (L = AUX snoop enabled and H = AUX snoop disabled with all lanes active).
HPDIN/ RSVD2 <sup>(1)</sup>	32	I/O (PD)	When I2C_EN != 0, this pin is reserved. Leave open if not used. When I2C_EN = 0, this pin is an input for Hot Plug Detect received from DisplayPort sink. When HPDIN is Low for greater than 2ms, all DisplayPort lanes are disabled while the AUX to SBU switch will remain closed.
I2C_EN	17	4 Level I	I <sup>2</sup> C Programming Mode or GPIO Programming Select. I2C is only disabled when this pin is '0'. 0 = GPIO mode (I <sup>2</sup> C disabled) R = TI Test Mode (I <sup>2</sup> C enabled at 3.3 V) F = I <sup>2</sup> C enabled at 1.8 V 1 = I <sup>2</sup> C enabled at 3.3 V.
SBU1	27	I/O, CMOS	SBU1. This pin should be DC coupled to the SBU1 pin on the Type-C receptacle. A 2-M ohm resistor to GND is also recommended.
SBU2	26	I/O, CMOS	SBU2. This pin should be DC coupled to the SBU2 pin on the Type-C receptacle. A 2-M ohm resistor to GND is also recommended.
AUXp	24	I/O, CMOS	AUXp. DisplayPort AUX positive I/O connected to the DisplayPort source through a AC coupling capacitor. In addition to AC coupling capacitor, this pin also requires a 100K resistor to GND. This pin along with AUXN is used by the TUSB546-DCI for AUX snooping and is routed to SBU1/2 based on the orientation of the Type-C.
AUXn	25	I/O, CMOS	AUXn. DisplayPort AUX negative I/O connected to the DisplayPort source through a AC coupling capacitor. In addition to AC coupling capacitor, this pin also requires a 100K resistor to DP_PWR (3.3V). This pin along with AUXP is used by the TUSB546-DCI for AUX snooping and is routed to SBU1/2 based on the orientation of the Type-C.
DPEQ1	2	4 Level I	DisplayPort Receiver EQ. This along with DPEQ0 will select the DisplayPort receiver equalization gain.
DPEQ0/A1	14	4 Level I	DisplayPort Receiver EQ. This along with DPEQ1 will select the DisplayPort receiver equalization gain. When I2C_EN is not '0', this pin will also set the TUSB546-DCI I <sup>2</sup> C address.
SSEQ1	3	4 Level I	Along with SSEQ0, sets the USB receiver equalizer gain for upstream facing SSTXP/N.
SSEQ0/A0	11	4 Level I	Along with SSEQ1, sets the USB receiver equalizer gain for upstream facing SSTXP/N. When I2C_EN is not '0', this pin will also set the TUSB546-DCI I <sup>2</sup> C address. If I2C_EN = "F", then this pin must be set to "F" or "0".
FLIP/SCL	21	2 Level I	When I2C_EN='0' this is Flip control pin, otherwise this pin is I <sup>2</sup> C clock. . When used for I <sup>2</sup> C clock pullup to I <sup>2</sup> C controller's VCC I2C supply.
CTL0/SDA	22	2 Level I	When I2C_EN='0' this is a USB3.1 Switch control pin, otherwise this pin is I <sup>2</sup> C data. When used for I <sup>2</sup> C data pullup to I <sup>2</sup> C controller's VCC I2C supply.
CTL1/HPDIN	23	2 Level I (Failsafe) (PD)	DP Alt mode Switch Control Pin. When I2C_EN = '0', this pin will enable or disable DisplayPort functionality. Otherwise, when I2C_EN is not "0", DisplayPort functionality is enabled and disabled through I <sup>2</sup> C registers. L = DisplayPort Disabled. H = DisplayPort Enabled. When I2C_EN is not "0" this pin is an input for Hot Plug Detect received from DisplayPort sink. When this HPDIN is Low for greater than 2 ms, all DisplayPort lanes are disabled and AUX to SBU switch will remain closed.
VCC	1, 6, 20, 28	P	3.3-V Power Supply
Thermal Pad		G	Ground

(1) Not a fail-safe I/O. Actively driving pin high while VCC is removed results in leakage voltage on VCC pins.

## 6 Specifications

### 6.1 Absolute Maximum Ratings

over operating free-air temperature range (unless otherwise noted)<sup>(1)</sup>

		MIN	MAX	UNIT
Supply Voltage Range <sup>(2)</sup> , $V_{CC}$		-0.3	4	V
Voltage Range at any input or output pin	Differential voltage between positive and negative inputs		±2.5	V
	Voltage at differential inputs	-0.5	$V_{CC} + 0.5$	V
	CMOS Inputs	-0.5	$V_{CC} + 0.5$	V
Maximum junction temperature, $T_J$			125	°C
Storage temperature, $T_{stg}$		-65	150	°C

- (1) Stresses beyond those listed under *Absolute Maximum Ratings* may cause permanent damage to the device. These are stress ratings only, which do not imply functional operation of the device at these or any other conditions beyond those indicated under *Recommended Operating Conditions*. Exposure to absolute-maximum-rated conditions for extended periods may affect device reliability.
- (2) All voltage values are with respect to the GND terminals.

### 6.2 ESD Ratings

		VALUE	UNIT
$V_{(ESD)}$ Electrostatic discharge	Human-body model (HBM), per ANSI/ESDA/JEDEC JS-001 <sup>(1)</sup>	±5000	V
	Charged-device model (CDM), per JEDEC specification JESD22-C101 <sup>(2)</sup>	±1500	

- (1) JEDEC document JEP155 states that 500-V HBM allows safe manufacturing with a standard ESD control process.
- (2) JEDEC document JEP157 states that 250-V CDM allows safe manufacturing with a standard ESD control process.

### 6.3 Recommended Operating Conditions

over operating free-air temperature range (unless otherwise noted)

		MIN	NOM	MAX	UNIT
$V_{CC}$	Main power supply	3	3.3	3.6	V
	Supply Ramp Requirement			100	ms
$V_{(12C)}$	Supply that external resistors are pulled up to on SDA and SCL	1.7		3.6	V
$V_{(PSN)}$	Supply Noise on $V_{CC}$ pins			100	mV
$T_A$	Operating free-air temperature	TUSB546-DCI	0	70	°C
		TUSB546I-DCI	-40	85	°C

### 6.4 Thermal Information

THERMAL METRIC <sup>(1)</sup>		TUSB546-DCI	UNIT
		RNQ (WQFN)	
		40 PINS	
$R_{\theta JA}$	Junction-to-ambient thermal resistance	37.6	°C/W
$R_{\theta JC(top)}$	Junction-to-case (top) thermal resistance	20.7	°C/W
$R_{\theta JB}$	Junction-to-board thermal resistance	9.5	°C/W
$\Psi_{JT}$	Junction-to-top characterization parameter	0.2	°C/W
$\Psi_{JB}$	Junction-to-board characterization parameter	9.4	°C/W
$R_{\theta JC(bot)}$	Junction-to-case (bottom) thermal resistance	2.3	°C/W

- (1) For more information about traditional and new thermal metrics, see the [Semiconductor and IC Package Thermal Metrics](#) application report.

## 6.5 Power Supply Characteristics

over operating free-air temperature range (unless otherwise noted)

PARAMETER		TEST CONDITIONS	MIN	TYP	MAX	UNIT
$P_{CC(ACTIVE-USB)}$	Average active power USB Only	Link in U0 with GEN1 data transmission. EN, EQ cntrl pins = NC, k28.5 pattern at 5 Gbps, $V_{ID} = 1000$ mV <sub>PP</sub> ; CTL1 = L; CTL0 = H		335		mW
$P_{CC(ACTIVE-USB-DP1)}$	Average active power USB + 2 Lane DP	Link in U0 with GEN1 data transmission. EN, EQ cntrl pins = NC, k28.5 pattern at 5 Gbps, $V_{ID} = 1000$ mV <sub>PP</sub> ; CTL1 = H; CTL0 = H		634		mW
$P_{CC(ACTIVE-DP)}$	Average active power 4 Lane DP Only	Four active DP lanes operating at 8.1Gbps; CTL1 = H; CTL0 = L;		660		mW
$P_{CC(NC-USB)}$	Average power with no connection	No GEN1 device is connected to TXP/TXN; CTL1 = L; CTL0 = H;		2.4		mW
$P_{CC(U2U3)}$	Average power in U2/U3	Link in U2 or U3 USB Mode Only; CTL1 = L; CTL0 = H;		3.0		mW
$P_{CC(SHUTDOWN)}$	Device Shutdown	CTL1 = L; CTL0 = L; I2C_EN = 0;		0.85		mW

## 6.6 DC Electrical Characteristics

over operating free-air temperature range (unless otherwise noted)

PARAMETER		TEST CONDITIONS	MIN	TYP	MAX	UNIT
<b>4-State CMOS Inputs(EQ[1:0], SSEQ[1:0], DPEQ[1:0], I2C_EN)</b>						
$I_{IH}$	High level input current	$V_{CC} = 3.6$ V; $V_{IN} = 3.6$ V	20		80	$\mu$ A
$I_{IL}$	Low level input current	$V_{CC} = 3.6$ V; $V_{IN} = 0$ V	-160		-40	$\mu$ A
4-Level $V_{TH}$	Threshold 0 / R	$V_{CC} = 3.3$ V		0.55		V
	Threshold R/ Float	$V_{CC} = 3.3$ V		1.65		V
	Threshold Float / 1	$V_{CC} = 3.3$ V		2.7		V
$R_{PU}$	Internal pull-up resistance			35		k $\Omega$
$R_{PD}$	Internal pull-down resistance			95		k $\Omega$
<b>2-State CMOS Input (CTL0, CTL1, FLIP, CAD_SNK, HPDIN) CTL1, CTL0 and FLIP are Failsafe.</b>						
$V_{IH}$	High-level input voltage		2		3.6	V
$V_{IL}$	Low-level input voltage		0		0.8	V
$R_{PD}$	Internal pull-down resistance for CTL1			500		k $\Omega$
$R_{(ENPD)}$	Internal pull-down resistance for CAD_SNK (pin 29), and HPDIN (pin 32)			150		k $\Omega$
$I_{IH}$	High-level input current	$V_{IN} = 3.6$ V	-25		25	$\mu$ A
$I_{IL}$	Low-level input current	$V_{IN} = GND$ , $V_{CC} = 3.6$ V	-25		25	$\mu$ A
<b>I<sup>2</sup>C Control Pins SCL, SDA</b>						
$V_{IH}$	High-level input voltage	I2C_EN = 0	$0.7 \times V_{(I2C)}$		3.6	V
$V_{IL}$	Low-level input voltage	I2C_EN = 0	0	$0.3 \times V_{(I2C)}$		V
$V_{OL}$	Low-level output voltage	I2C_EN = 0; $I_{OL} = 3$ mA	0		0.4	V
$I_{OL}$	Low-level output current	I2C_EN = 0; $V_{OL} = 0.4$ V	20			mA
$I_{I(I2C)}$	Input current on SDA pin	$0.1 \times V_{(I2C)} < \text{Input voltage} < 3.3$ V	-10		10	$\mu$ A
$C_{I(I2C)}$	Input capacitance				10	pF
$C_{(I2C\_FM+\_BUS)}$	I2C bus capacitance for FM+ (1MHz)				150	pF
$C_{(I2C\_FM\_BUS)}$	I2C bus capacitance for FM (400kHz)				150	pF
$R_{(EXT\_I2C\_FM+)}$	External resistors on both SDA and SCL when operating at FM+ (1MHz)	$C_{(I2C\_FM+\_BUS)} = 150$ pF	620	820	910	$\Omega$
$R_{(EXT\_I2C\_FM)}$	External resistors on both SDA and SCL when operating at FM (400kHz)	$C_{(I2C\_FM\_BUS)} = 150$ pF	620	1500	2200	$\Omega$

## 6.7 AC Electrical Characteristics

over operating free-air temperature range (unless otherwise noted)

PARAMETER		TEST CONDITIONS	MIN	TYP	MAX	UNIT
<b>USB Gen 1 Differential Receiver (RX1P/N, RX2P/N, SSTXP/N)</b>						
$V_{(RX-DIFF-PP)}$	Input differential peak-peak voltage swing linear dynamic range	AC-coupled differential peak-to-peak signal measured post CTLE through a reference channel		2000		mVpp
$V_{(RX-DC-CM)}$	Common-mode voltage bias in the receiver (DC)		0		2	V
$R_{(RX-DIFF-DC)}$	Differential input impedance (DC)	Present after a GEN1 device is detected on TXP/TXN	72		120	$\Omega$
$R_{(RX-CM-DC)}$	Receiver DC common mode impedance	Present after a GEN1 device is detected on TXP/TXN	18		30	$\Omega$
$Z_{(RX-HIGH-IMP-DC-POS)}$	Common-mode input impedance with termination disabled (DC)	Present when no GEN1 device is detected on TXP/TXN. Measured over the range of 0-500mV with respect to GND.	25			k $\Omega$
$V_{(SIGNAL-DET-DIFF-PP)}$	Input differential peak-to-peak signal detect assert level	At 5 Gbps, no input loss, PRBS7 pattern		80		mV
$V_{(RX-IDLE-DET-DIFF-PP)}$	Input differential peak-to-peak signal detect de-assert Level	At 5 Gbps, no input loss, PRBS7 pattern		60		mV
$V_{(RX-LFPS-DET-DIFF-PP)}$	Low frequency periodic signaling (LFPS) detect threshold	Below the minimum is squelched	100		300	mV
$V_{(RX-CM-AC-P)}$	Peak RX AC common-mode voltage	Measured at package pin			150	mV
$C_{(RX)}$	RX input capacitance to GND	At 2.5 GHz		0.5	1	pF
$R_{L(RX-DIFF)}$	Differential return Loss	50 MHz – 1.25 GHz at 90 $\Omega$		-19		dB
		2.5 GHz at 90 $\Omega$		-14		dB
$R_{L(RX-CM)}$	Common-mode return loss	50 MHz – 2.5 GHz at 90 $\Omega$		-13		dB
$E_{Q(SSP)}$	Receiver equalization	SSEQ[1:0] and EQ[1:0] at 2.5 GHz			11	dB
<b>USB Gen 1 Differential Transmitter (TX1P/N, TX2P/N, SSRXP/N)</b>						
$V_{TX(DIFF-PP)}$	Transmitter dynamic differential voltage swing range.			1500		mV <sub>PP</sub>
$V_{TX(RCV-DETECT)}$	Amount of voltage change allowed during receiver detection				600	mV
$V_{TX(CM-IDLE-DELTA)}$	Transmitter idle common-mode voltage change while in U2/U3 and not actively transmitting LFPS		-600		600	mV
$V_{TX(DC-CM)}$	Common-mode voltage bias in the transmitter (DC)		0		2	V
$V_{TX(CM-AC-PP-ACTIVE)}$	Tx AC common-mode voltage active	Max mismatch from Txp + Txn for both time and amplitude			100	mV <sub>PP</sub>
$V_{TX(IDLE-DIFF-AC-PP)}$	AC electrical idle differential peak-to-peak output voltage	At package pins	0		10	mV
$V_{TX(IDLE-DIFF-DC)}$	DC electrical idle differential output voltage	At package pins after low pass filter to remove AC component	0		14	mV
$V_{TX(CM-DC-ACTIVE-IDLE-DELTA)}$	Absolute DC common-mode voltage between U1 and U0	At package pin			200	mV
$R_{TX(DIFF)}$	Differential impedance of the driver		75		120	$\Omega$
$C_{AC(COUPLING)}$	AC coupling capacitor		75		265	nF
$R_{TX(CM)}$	Common-mode impedance of the driver	Measured with respect to AC ground over 0–500 mV	18		30	$\Omega$
$I_{TX(SHORT)}$	TX short circuit current	TX± shorted to GND			67	mA
$C_{TX(PARASITIC)}$	TX input capacitance for return loss	At package pins, at 2.5 GHz			1.25	pF
$R_{LTX(DIFF)}$	Differential return loss	50 MHz – 1.25 GHz at 90 $\Omega$		-15		dB
		2.5 GHz at 90 $\Omega$		-12		dB
$R_{LTX(CM)}$	Common-mode return loss	50 MHz – 2.5 GHz at 90 $\Omega$		-13		dB
<b>AC Characteristics</b>						
Crosstalk	Differential crosstalk between TX and RX signal pairs	at 2.5 GHz		-30		dB
$C_{(P1dB-LF)}$	Low frequency 1-dB compression point	at 100 MHz, 200 mV <sub>PP</sub> < V <sub>ID</sub> < 2000 mV <sub>PP</sub>		1300		mV <sub>PP</sub>

## 6.7 AC Electrical Characteristics (continued)

over operating free-air temperature range (unless otherwise noted)

PARAMETER		TEST CONDITIONS	MIN	TYP	MAX	UNIT
$C_{(P1dB-HF)}$	High frequency 1-dB compression point	at 2.5 GHz, 200 mV <sub>PP</sub> < V <sub>ID</sub> < 2000 mV <sub>PP</sub>		1300		mV <sub>PP</sub>
$f_{LF}$	Low frequency cutoff	200 mV <sub>PP</sub> < V <sub>ID</sub> < 2000 mV <sub>PP</sub>		20	50	kHz
	TX output deterministic jitter	200 mV <sub>PP</sub> < V <sub>ID</sub> < 2000 mV <sub>PP</sub> , PRBS7, 5 Gbps		0.05		U <sub>Ipp</sub>
		200 mV <sub>PP</sub> < V <sub>ID</sub> < 2000 mV <sub>PP</sub> , PRBS7, 8.1 Gbps		0.08		U <sub>Ipp</sub>
	TX output total jitter	200 mV <sub>PP</sub> < V <sub>ID</sub> < 2000 mV <sub>PP</sub> , PRBS7, 5 Gbps		0.08		U <sub>Ipp</sub>
		200 mV <sub>PP</sub> < V <sub>ID</sub> < 2000 mV <sub>PP</sub> , PRBS7, 8.1 Gbps		0.135		U <sub>Ipp</sub>
<b>DisplayPort Receiver (DP[3:0]p or DP[3:0]n)</b>						
V <sub>ID(PP)</sub>	Peak-to-peak input differential dynamic voltage range			2000		V
V <sub>IC</sub>	Input common mode voltage		0		2	V
C <sub>(AC)</sub>	AC coupling capacitance		75		200	nF
E <sub>Q(DP)</sub>	Receiver equalization	DPEQ[1:0] at 4.05 GHz			14	dB
d <sub>R</sub>	Data rate	HBR3			8.1	Gbps
R <sub>(ti)</sub>	Input termination resistance		80	100	120	Ω
<b>DisplayPort Transmitter (TX1p or TX1n, TX2p or TX2n, RX1p or RX1n, RX2p or RX2n)</b>						
I <sub>TX(SHORT)</sub>	TX short circuit current	TX± shorted to GND			67	mA
V <sub>TX(DC-CM)</sub>	Common-mode voltage bias in the transmitter (DC)		0		0	V
<b>AUXp or AUXn and SBU1 or SBU2</b>						
R <sub>ON</sub>	Output ON resistance	V <sub>CC</sub> = 3.3V; V <sub>I</sub> = 0 to 0.4 V for AUXp; V <sub>I</sub> = 2.7 V to 3.6 V for AUXn		5	10	Ω
ΔR <sub>ON</sub>	ON resistance mismatch within pair	V <sub>CC</sub> = 3.3 V; V <sub>I</sub> = 0 to 0.4 V for AUXp; V <sub>I</sub> = 2.7 V to 3.6 V for AUXn			2.5	Ω
R <sub>ON(FLAT)</sub>	ON resistance flatness (RON max – RON min) measured at identical VCC and temperature	V <sub>CC</sub> = 3.3 V; V <sub>I</sub> = 0 to 0.4 V for AUXp; V <sub>I</sub> = 2.7 V to 3.6 V for AUXn			2	Ω
V <sub>(AUXP_DC_CM)</sub>	AUX Channel DC common mode voltage for AUXp and SBU1.	V <sub>CC</sub> = 3.3 V	0		0.4	V
V <sub>(AUXN_DC_CM)</sub>	AUX Channel DC common mode voltage for AUXn and SBU2	V <sub>CC</sub> = 3.3 V	2.7		3.6	V
C <sub>(AUX_ON)</sub>	ON-state capacitance	V <sub>CC</sub> = 3.3 V; CTL1 = 1; V <sub>I</sub> = 0 V or 3.3 V		4	7	pF
C <sub>(AUX_OFF)</sub>	OFF-state capacitance	V <sub>CC</sub> = 3.3 V; CTL1 = 0; V <sub>I</sub> = 0 V or 3.3 V		3	6	pF

## 6.8 Timing Requirements

			MIN	NOM	MAX	UNIT
<b>USB Gen 1</b>						
t <sub>IDLEEntry</sub>	Delay from U0 to electrical idle	See <a href="#">Figure 7-4</a>		10		ns
t <sub>IDLEExit_U1</sub>	U1 exist time: break in electrical idle to the transmission of LFPS	See <a href="#">Figure 7-4</a>		6		ns
t <sub>IDLEExit_U2U3</sub>	U2/U3 exit time: break in electrical idle to transmission of LFPS			10		μs
t <sub>RXDET_INTVL</sub>	RX detect interval while in Disconnect				12	ms
t <sub>IDLEExit_DISC</sub>	Disconnect Exit Time			10		μs
t <sub>Exit_SHTDN</sub>	Shutdown Exit Time			1		ms
t <sub>DIFF_DLY</sub>	Differential Propagation Delay	See <a href="#">Figure 7-3</a>			300	ps
t <sub>R</sub> , t <sub>F</sub>	Output Rise/Fall time (see <a href="#">Figure 7-5</a> )	20%-80% of differential voltage measured 1 inch from the output pin	40			ps



			MIN	NOM	MAX	UNIT
t <sub>RF_MM</sub>	Output Rise/Fall time mismatch	20%-80% of differential voltage measured 1 inch from the output pin			2.6	ps

## 6.9 Switching Characteristics

over operating free-air temperature range (unless otherwise noted)

PARAMETER	TEST CONDITIONS	MIN	TYP	MAX	UNIT
<b>AUXp or AUXn and SBU1 or SBU2</b>					
t <sub>AUX_PD</sub>	Switch propagation delay			400	ps
t <sub>AUX_SW_OFF</sub>	Switching time CTL1 to switch OFF. Not including TCTL1_DEBOUNCE.			500	ns
t <sub>AUX_SW_ON</sub>	Switching time CTL1 to switch ON			500	ns
t <sub>AUX_INTRA</sub>	Intra-pair output skew			100	ps
<b>USB3.1 and DisplayPort mode transition requirement GPIO mode</b>					
t <sub>GP_USB_4DP</sub>	Min overlap of CTL0 and CTL1 when transitioning from USB 3.1 only mode to 4-Lane DisplayPort mode or vice versa.	4			μs
<b>CTL1 and HPDIN</b>					
t <sub>CTL1_DEBOUNCE</sub>	CTL1 and HPDIN debounce time when transitioning from H to L.	2		10	ms
<b>I<sup>2</sup>C (Refer to Figure 7-1)</b>					
f <sub>SCL</sub>	I <sup>2</sup> C clock frequency			1	MHz
t <sub>BUF</sub>	Bus free time between START and STOP conditions	0.5			μs
t <sub>HDSTA</sub>	Hold time after repeated START condition. After this period, the first clock pulse is generated	0.26			μs
t <sub>LOW</sub>	Low period of the I <sup>2</sup> C clock	0.5			μs
t <sub>HIGH</sub>	High period of the I <sup>2</sup> C clock	0.26			μs
t <sub>SUSTA</sub>	Setup time for a repeated START condition	0.26			μs
t <sub>HDDAT</sub>	Data hold time	0			μs
t <sub>SUDAT</sub>	Data setup time	50			ns
t <sub>R</sub>	Rise time of both SDA and SCL signals			120	ns
t <sub>F</sub>	Fall time of both SDA and SCL signals	20 × (V <sub>I2C</sub> /5.5 V)		120	ns
t <sub>SUSTO</sub>	Setup time for STOP condition	0.26			μs
C <sub>b</sub>	Capacitive load for each bus line			150	pF

## 6.10 Typical Characteristics

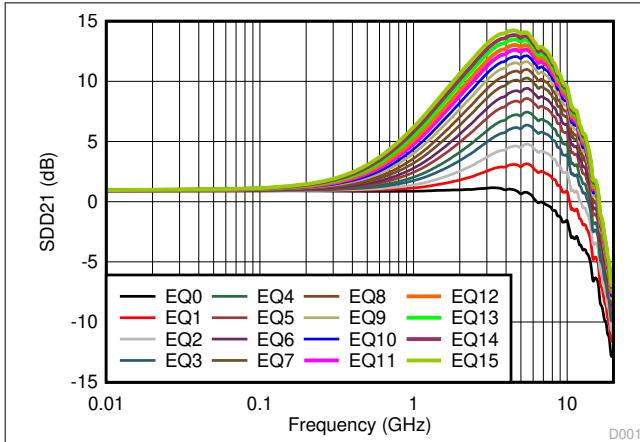

Figure 6-1. DisplayPort EQ Settings Curves

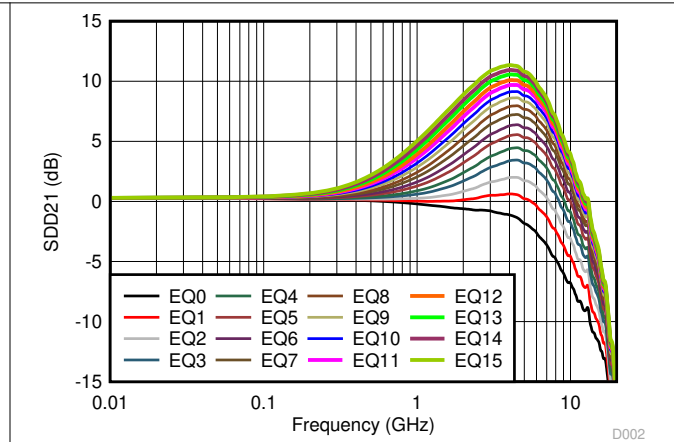

Figure 6-2. USB RX EQ Settings Curves

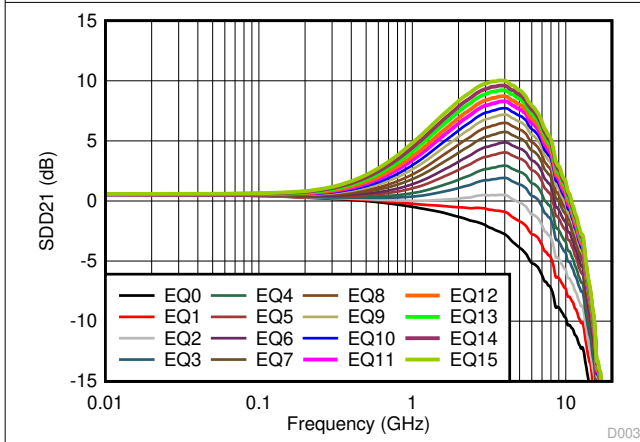

Figure 6-3. USB TX EQ Settings Curves

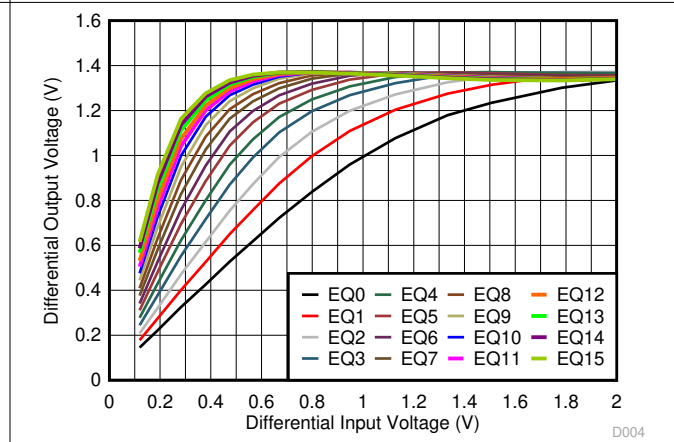

Figure 6-4. DisplayPort Linearity Curves at 4.05 GHz

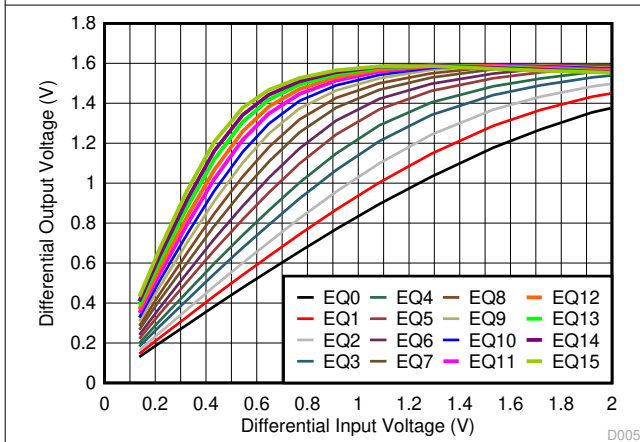

Figure 6-5. USB TX Linearity Curves at 2.5 GHz

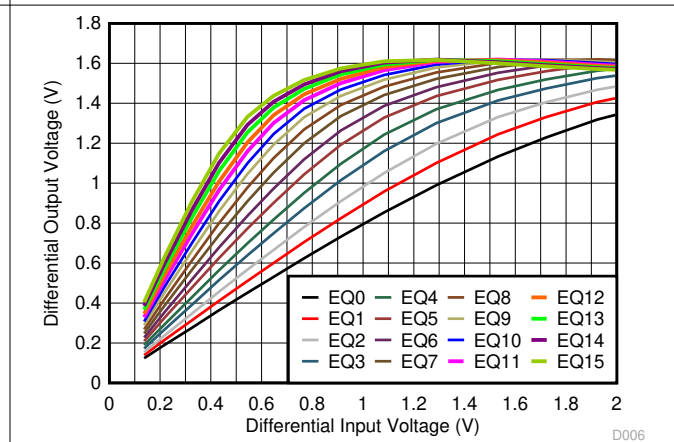
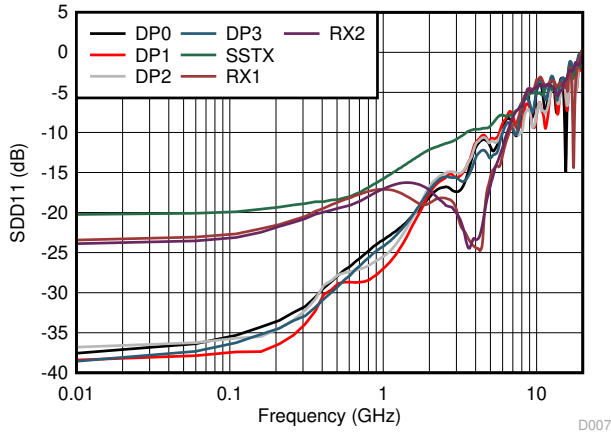
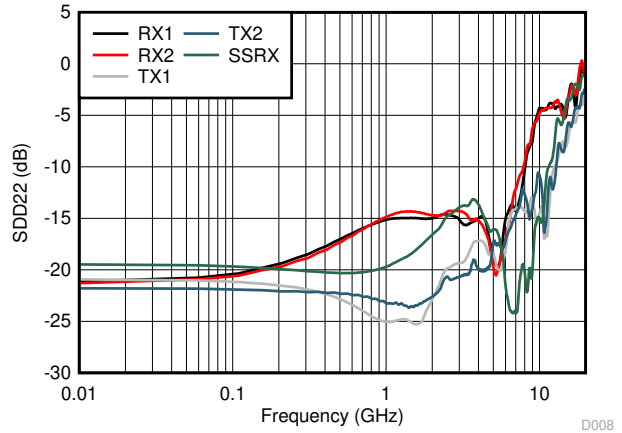

Figure 6-6. USB RX Linearity Curves at 2.5 GHz



**Figure 6-7. Input Return Loss Performance**



**Figure 6-8. Output Return Loss Performance**

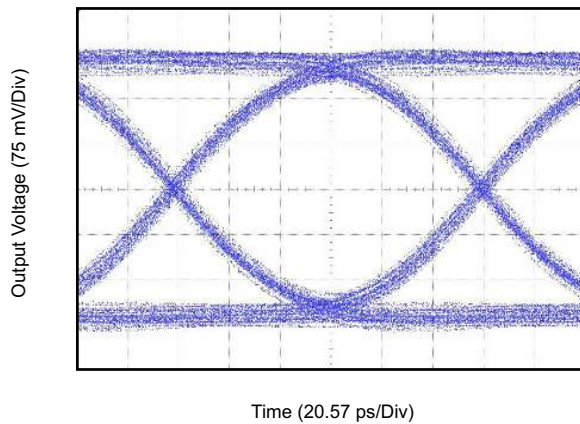

**Figure 6-9. DisplayPort HBR3 Eye-Pattern Performance with 12-inch Input PCB Trace at 8.1 Gbps**

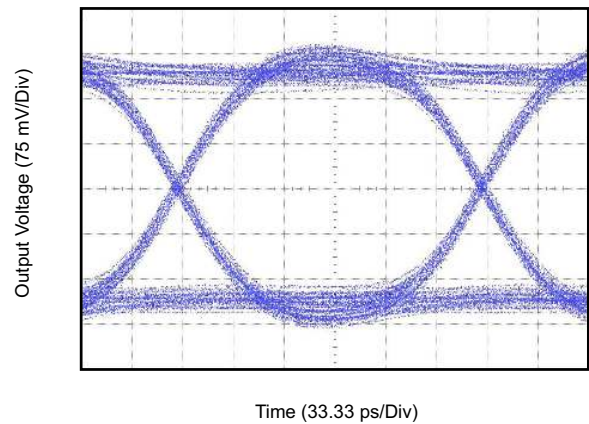

**Figure 6-10. USB 3.1 Gen1 Eye-Pattern Performance with 12-inch Input PCB Trace at 5 Gbps**

## Parameter Measurement Information

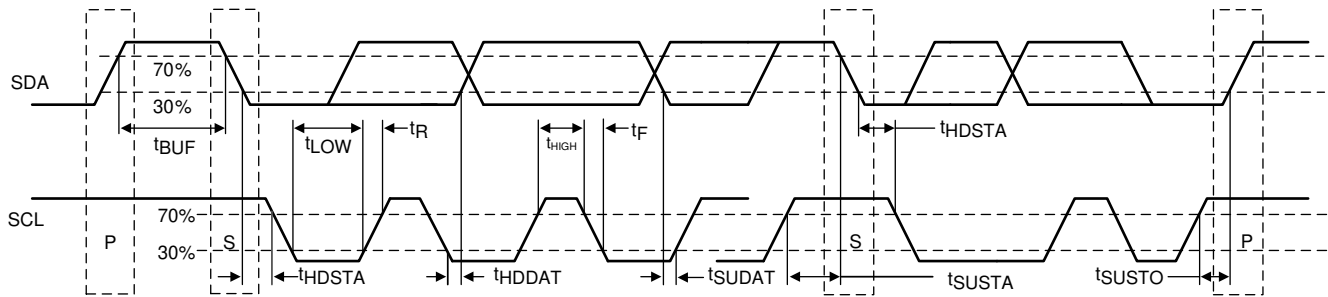

Figure 7-1. I<sup>2</sup>C Timing Diagram Definitions

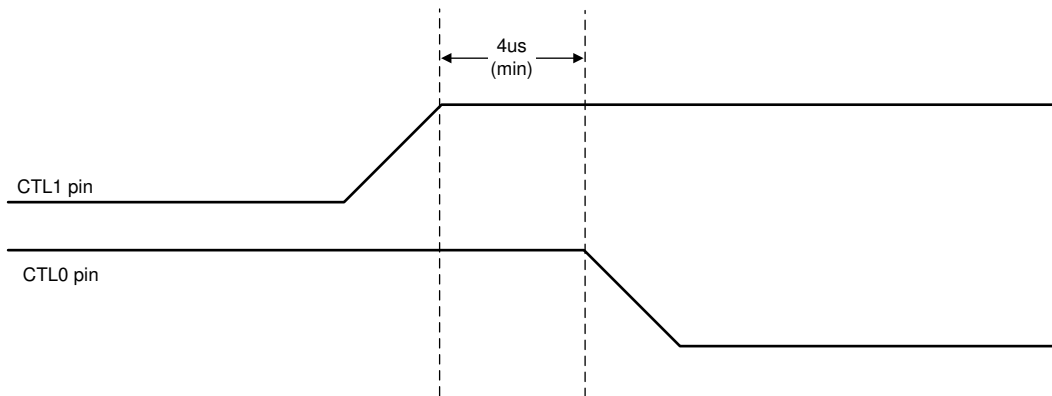

Figure 7-2. USB3.1 to 4-Lane DisplayPort in GPIO Mode

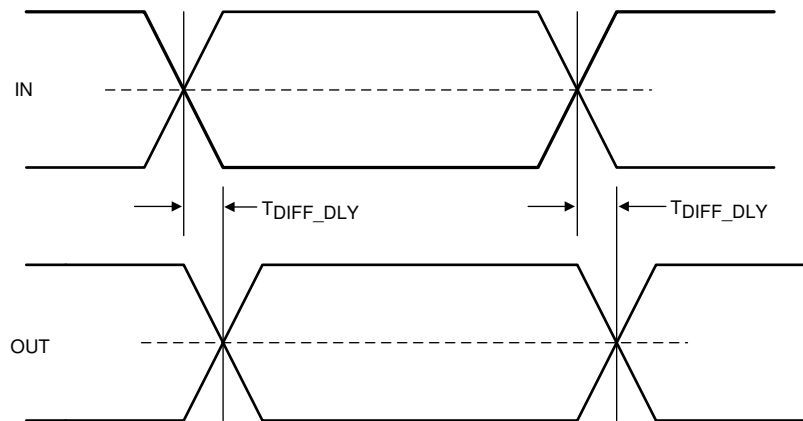
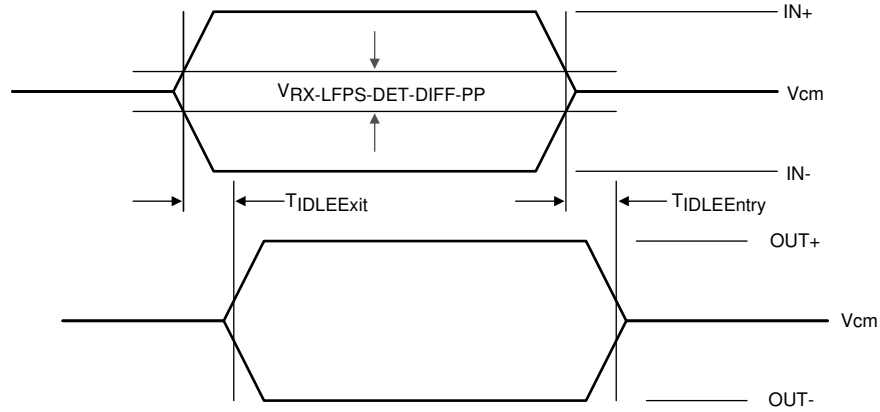
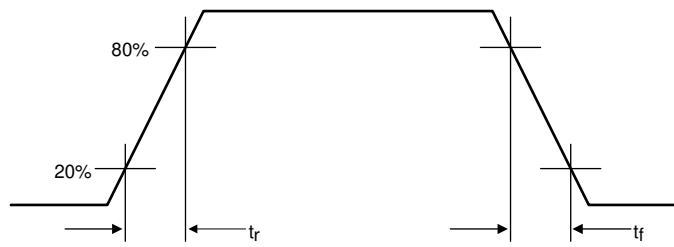

Figure 7-3. Propagation Delay



**Figure 7-4. Electrical Idle Mode Exit and Entry Delay**



**Figure 7-5. Output Rise and Fall Times**

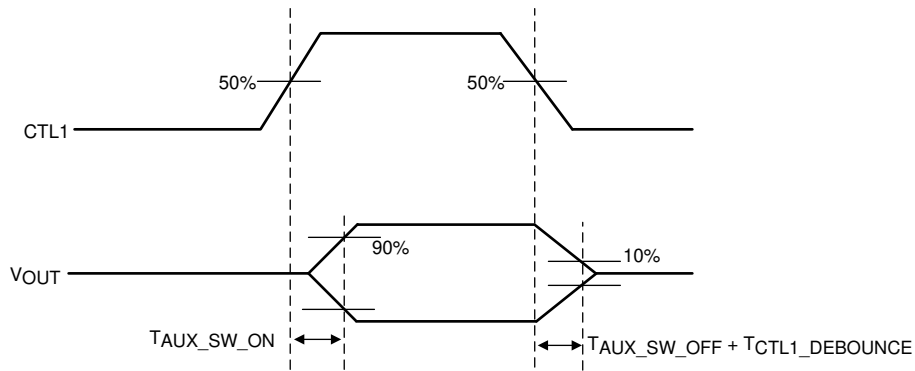

**Figure 7-6. AUX and SBU Switch ON and OFF Timing Diagram**

## 7 Detailed Description

### 7.1 Overview

The TUSB546-DCI is a VESA USB Type-C Alt Mode re-driving switch supporting data rates up to 8.1 Gbps for downstream facing port. These devices utilize 5<sup>th</sup> generation USB re-driver technology. The devices are utilized for DFP configurations C, D, E, and F from the VESA DisplayPort Alt Mode on USB Type-C.

The TUSB546-DCI provides several levels of receive equalization to compensate for cable and board trace loss due to inter-symbol interference (ISI) when USB 3.1 Gen1 or DisplayPort 1.4 signals travel across a PCB or cable. This device requires a 3.3-V power supply. It comes in a commercial temperature range and industrial temperature range.

For a host application the TUSB546-DCI enables the system to pass both transmitter compliance and receiver jitter tolerance tests for USB 3.1 Gen 1 and DisplayPort version 1.4 HBR3. The re-driver recovers incoming data by applying equalization that compensates for channel loss, and drives out signals with a high differential voltage. Each channel has a receiver equalizer with selectable gain settings. The equalization should be set based on the amount of insertion loss before the TUSB546-DCI receivers. Independent equalization control for each channel can be set using EQ[1:0], SSEQ[1:0], and DPEQ[1:0] pins.

The TUSB546-DCI advanced state machine makes it transparent to hosts and devices. After power up, the TUSB546-DCI periodically performs receiver detection on the TX pairs. If it detects a USB 3.1 Gen1 receiver, the RX termination is enabled, and the TUSB546-DCI is ready to re-drive.

The device ultra-low-power architecture operates at a 3.3-V power supply and achieves Enhanced performance. The automatic LFPS De-Emphasis control further enables the system to be USB3.1 compliant.

## 7.2 Functional Block Diagram

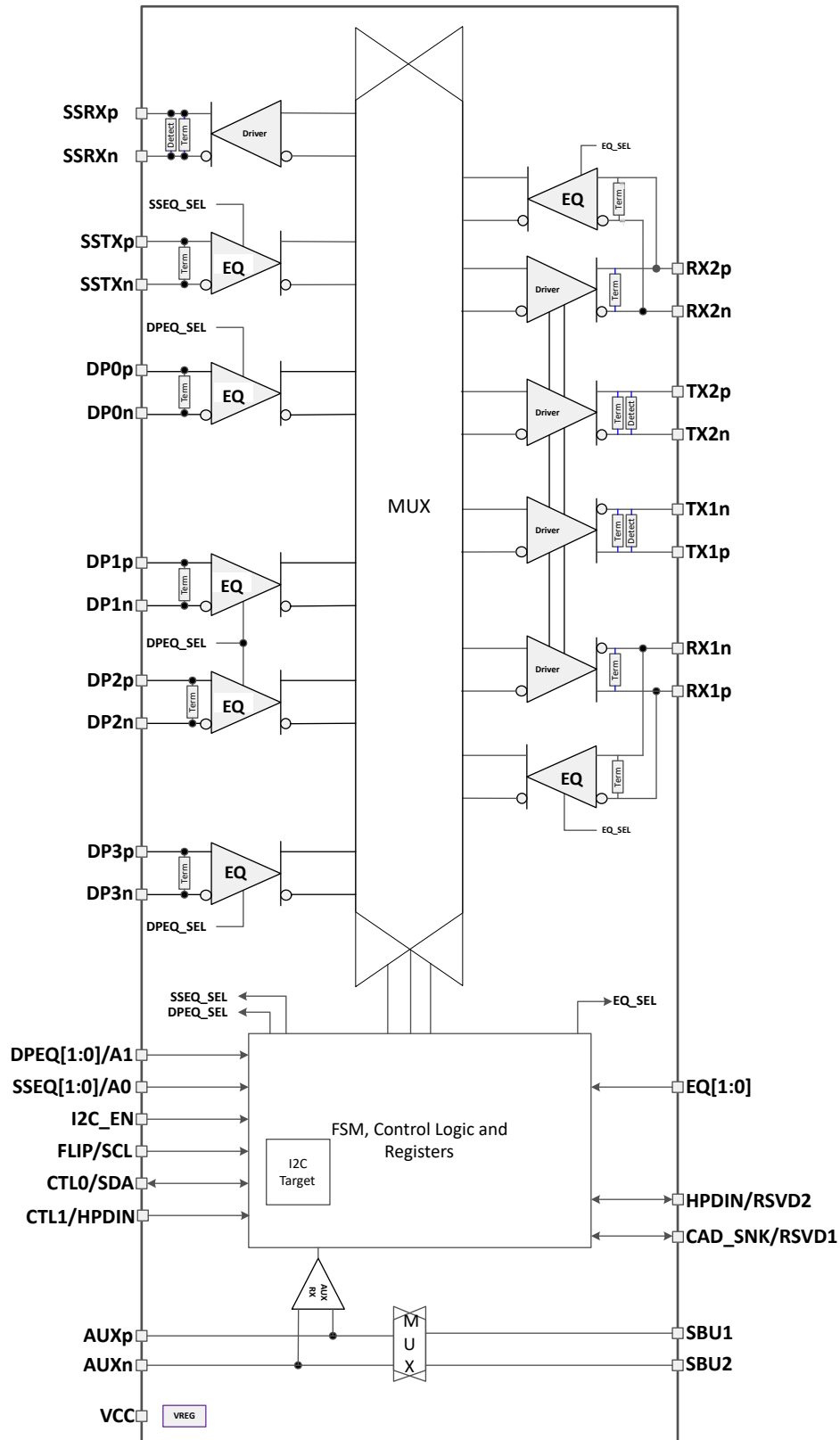

Copyright © 2016, Texas Instruments Incorporated

## 7.3 Feature Description

### 7.3.1 USB 3.1

The TUSB546-DCI supports USB 3.1 Gen1 datarates up to 5 Gbps. The TUSB546-DCI supports all the USB defined power states (U0, U1, U2, and U3). Because the TUSB546-DCI is a linear redriver, it can't decode USB3.1 physical layer traffic. The TUSB546-DCI monitors the actual physical layer conditions like receiver termination, electrical idle, LFPS, and SuperSpeed signaling rate to determine the USB power state of the USB 3.1 interface.

The TUSB546-DCI features an intelligent low frequency periodic signaling (LFPS) detector. The LFPS detector automatically senses the low frequency signals and disables receiver equalization functionality. When not receiving LFPS, the TUSB546-DCI will enable receiver equalization based on the EQ[1:0] and SSEQ[1:0] pins or values programmed into EQ1\_SEL, EQ2\_SEL, and SSEQ\_SEL registers.

### 7.3.2 DisplayPort

The TUSB546-DCI supports up to 4 DisplayPort lanes at datarates up to 8.1Gbps (HBR3). The TUSB546-DCI, when configured in DisplayPort mode, monitors the native AUX traffic as it traverses between DisplayPort source and DisplayPort sink. For the purposes of reducing power, the TUSB546-DCI manages the number of active DisplayPort lanes based on the content of the AUX transactions. The TUSB546-DCI snoops native AUX writes to DisplayPort sink's DPCD registers 0x00101 (LANE\_COUNT\_SET) and 0x00600 (SET\_POWER\_STATE). TUSB546-DCI disables/enables lanes based on value written to LANE\_COUNT\_SET. The TUSB546-DCI disables all lanes when SET\_POWER\_STATE is in the D3. Otherwise active lanes will be based on value of LANE\_COUNT\_SET.

DisplayPort AUX snooping is enabled by default but can be disabled by changing the AUX\_SNOOP\_DISABLE register. Once AUX snoop is disabled, management of TUSB546-DCI DisplayPort lanes are controlled through various configuration registers. When TUSB546-DCI is enabled for GPIO mode (I2C\_EN = "0"), the CAD\_SNK pin can be used to disable AUX snooping. When CAD\_SNK pin is high, the AUX snooping functionality is disabled and all four DisplayPort lanes will be active.

### 7.3.3 4-Level Inputs

The TUSB546-DCI has (I2C\_EN, EQ[1:0], DPEQ[1:0], and SSEQ[1:0]) 4-level inputs pins that are used to control the equalization gain and place TUSB546-DCI into different modes of operation. These 4-level inputs utilize a resistor divider to help set the 4 valid levels and provide a wider range of control settings. There is an internal 30 k $\Omega$  pull-up and a 94 k $\Omega$  pull-down. These resistors, together with the external resistor connection combine to achieve the desired voltage level.

**Table 7-1. 4-Level Control Pin Settings**

LEVEL	SETTINGS
0	Option 1: Tie 1 K $\Omega$ 5% to GND. Option 2: Tie directly to GND.
R	Tie 20 K $\Omega$ 5% to GND.
F	Float (leave pin open)
1	Option 1: Tie 1 K $\Omega$ 5% to V <sub>CC</sub> . Option 2: Tie directly to V <sub>CC</sub> .

#### Note

All four-level inputs are latched on rising edge of internal reset. After  $t_{\text{cfg\_hd}}$ , the internal pull-up and pull-down resistors will be isolated in order to save power.



### 7.3.4 Receiver Linear Equalization

The purpose of receiver equalization is to compensate for channel insertion loss and inter-symbol interference in the system before the input of the TUSB546-DCI. The receiver overcomes these losses by attenuating the low frequency components of the signals with respect to the high frequency components. The proper gain setting should be selected to match the channel insertion loss before the input of the TUSB546-DCI receivers. Two 4-level inputs pins enable up to 16 possible equalization settings. USB3.1 upstream path, USB3.1 downstream path, and DisplayPort each have their own two 4-level inputs. The TUSB546-DCI also provides the flexibility of adjusting settings through I<sup>2</sup>C registers.

## 7.4 Device Functional Modes

### 7.4.1 Device Configuration in GPIO Mode

The TUSB546-DCI is in GPIO configuration when I2C\_EN = “0”. The TUSB546-DCI supports the following configurations: USB 3.1 only, 2 DisplayPort lanes + USB 3.1, or 4 DisplayPort lanes (no USB 3.1). The CTL1 pin controls whether DisplayPort is enabled. The combination of CTL1 and CTL0 selects between USB 3.1 only, 2 lanes of DisplayPort, or 4-lanes of DisplayPort as detailed in [Table 7-2](#). The AUXp or AUXn to SBU1 or SBU2 mapping is controlled based on [Table 7-3](#).

After power-up (V<sub>CC</sub> from 0 V to 3.3 V), the TUSB546-DCI defaults to USB3.1 mode. The USB PD controller upon detecting no device attached to Type-C port or USB3.1 operation not required by attached device must take TUSB546-DCI out of USB3.1 mode by transitioning the CTL0 pin from L to H and back to L.

### 7.4.2

**Table 7-2. GPIO Configuration Control**

CTL1 PIN	CTL0 PIN	FLIP PIN	TUSB546-DCI CONFIGURATION	VESA DisplayPort ALT MODE DFP_D CONFIGURATION
L	L	L	Power Down	—
L	L	H	Power Down	—
L	H	L	One Port USB 3.1 - No Flip	—
L	H	H	One Port USB 3.1 – With Flip	—
H	L	L	4 Lane DP - No Flip	C and E
H	L	H	4 Lane DP – With Flip	C and E
H	H	L	One Port USB 3.1 + 2 Lane DP- No Flip	D and F
H	H	H	One Port USB 3.1 + 2 Lane DP– With Flip	D and F

**Table 7-3. GPIO AUXp or AUXn to SBU1 or SBU2 Mapping**

CTL1 PIN	FLIP PIN	MAPPING
H	L	AUXp → SBU1 AUXn → SBU2
H	H	AUXp → SBU2 AUXn → SBU1
L > 2 ms	X	Open

Table 4 Details the TUSB546-DCI’s mux routing. This table is valid for both I<sup>2</sup>C and GPIO.

**Table 7-4. INPUT to OUTPUT Mapping**

CTL1 PIN	CTL0 PIN	FLIP PIN	FROM	TO
			INPUT PIN	OUTPUT PIN
L	L	L	NA	NA
L	L	H	NA	NA
L	H	L	RX1P	SSRXP
			RX1N	SSRXN
			SSTXP	TX1P
			SSTXN	TX1N
L	H	H	RX2P	SSRXP
			RX2N	SSRXN
			SSTXP	TX2P
			SSTXN	TX2P
H	L	L	DP0P	RX2P
			DP0N	RX2N
			DP1P	TX2P
			DP1N	TX2N
			DP2P	TX1P
			DP2N	TX1N
			DP3P	RX1P
			DP3N	RX1N
H	L	H	DP0P	RX1P
			DP0N	RX1N
			DP1P	TX1P
			DP1N	TX1N
			DP2P	TX2P
			DP2N	TX2N
			DP3P	RX2P
			DP3N	RX2N
H	H	L	RX1P	SSRXP
			RX1N	SSRXN
			SSTXP	TX1P
			SSTXN	TX1N
			DP0P	RX2P
			DP0N	RX2N
			DP1P	TX2P
			DP1N	TX2N
H	H	H	RX2P	SSRXP
			RX2N	SSRXN
			SSTXP	TX2P
			SSTXN	TX2N
			DP0P	RX1P
			DP0N	RX1N
			DP1P	TX1P
			DP1N	TX1N

### 7.4.3 Device Configuration In I<sup>2</sup>C Mode

The TUSB546-DCI is in I<sup>2</sup>C mode when I2C\_EN is not equal to “0”. The same configurations defined in GPIO mode are also available in I<sup>2</sup>C mode. The TUSB546-DCI USB3.1 and DisplayPort configuration is controlled based on [Table 7-5](#). The AUXp or AUXn to SBU1 or SBU2 mapping control is based on [Table 7-6](#).

**Table 7-5. I<sup>2</sup>C Configuration Control**

REGISTERS			TUSB546-DCI CONFIGURATION	VESA DisplayPort ALT MODE DFP_D CONFIGURATION
CTLSEL1	CTLSEL0	FLIPSEL		
L	L	L	Power Down	—
L	L	H	Power Down	—
L	H	L	One Port USB 3.1 - No Flip	—
L	H	H	One Port USB 3.1 – With Flip	—
H	L	L	4 Lane DP - No Flip	C and E
H	L	H	4 Lane DP – With Flip	C and E
H	H	L	One Port USB 3.1 + 2 Lane DP- No Flip	D and F
H	H	H	One Port USB 3.1 + 2 Lane DP– With Flip	D and F

**Table 7-6. I<sup>2</sup>C AUXp or AUXn to SBU1 or SBU2 Mapping**

	REGISTERS		MAPPING	
	AUX_SBU_OVR	CTLSEL1		FLIPSEL
0		H	L	AUXp → SBU1 AUXn → SBU2
0		H	H	AUXp → SBU2 AUXn → SBU1
0		L	X	Open
1		X	X	AUXp → SBU2 AUXn → SBU1

### 7.4.4 DisplayPort Mode

The TUSB546-DCI supports up to four DisplayPort lanes at datarates up to 8.1 Gbps. TUSB546-DCI can be enabled for DisplayPort through GPIO control or through I<sup>2</sup>C register control. When I2C\_EN is ‘0’, DisplayPort is controlled based on [Table 7-2](#). When not in GPIO mode, enable of DisplayPort functionality is controlled through I<sup>2</sup>C registers.

### 7.4.5 Linear EQ Configuration

Each of the TUSB546-DCI receiver lanes has individual controls for receiver equalization. The receiver equalization gain value can be controlled either through I<sup>2</sup>C registers or through GPIOs. Table 7-7 lists the gain value for each available combination when TUSB546-DCI is in GPIO mode. These same options are also available in I<sup>2</sup>C mode by updating registers DP0EQ\_SEL, DP1EQ\_SEL, DP2EQ\_SEL, DP3EQ\_SEL, EQ1\_SEL, EQ2\_SEL, and SSEQ\_SEL.

**Table 7-7. TUSB546-DCI Receiver Equalization GPIO Control**

Equalization Setting #	USB3.1 DOWNSTREAM FACING PORTS			USB 3.1 UPSTREAM FACING PORT			ALL DISPLAYPORT LANES		
	EQ1 PIN LEVEL	EQ0 PIN LEVEL	EQ GAIN at 2.5 GHz (dB)	SSEQ1 PIN LEVEL	SSEQ0 PIN LEVEL	EQ GAIN at 2.5 GHz (dB)	DPEQ1 PIN LEVEL	DPEQ0 PIN LEVEL	EQ GAIN at 4.05 GHz (dB)
0	0	0	0.2	0	0	-1.6	0	0	1.0
1	0	R	1.2	0	R	-0.5	0	R	3.3
2	0	F	2.2	0	F	0.5	0	F	4.9
3	0	1	3.3	0	1	1.6	0	1	6.5
4	R	0	4.2	R	0	2.4	R	0	7.5
5	R	R	5.1	R	R	3.4	R	R	8.6
6	R	F	5.9	R	F	4.1	R	F	9.5
7	R	1	6.7	R	1	4.9	R	1	10.4
8	F	0	7.4	F	0	5.7	F	0	11.1
9	F	R	8.1	F	R	6.4	F	R	11.7
10	F	F	8.7	F	F	6.9	F	F	12.3
11	F	1	9.3	F	1	7.5	F	1	12.8
12	1	0	9.7	1	0	8.0	1	0	13.2
13	1	R	10.2	1	R	8.5	1	R	13.6
14	1	F	10.6	1	F	8.9	1	F	14.0
15	1	1	11.1	1	1	9.4	1	1	14.4

### 7.4.6 USB3.1 Modes

The TUSB546-DCI monitors the physical layer conditions like receiver termination, electrical idle, LFPS, and SuperSpeed signaling rate to determine the state of the USB3.1 interface. Depending on the state of the USB 3.1 interface, the TUSB546-DCI can be in one of four primary modes of operation when USB 3.1 is enabled (CTL0 = H or CTLSEL0 = 1b1): Disconnect, U2/U3, U1, and U0.

The Disconnect mode is the state in which TUSB546-DCI has not detected far-end termination on both upstream facing port (UFP) or downstream facing port (DFP). The disconnect mode is the lowest power mode of each of the four modes. The TUSB546-DCI remains in this mode until far-end receiver termination has been detected on both UFP and DFP. The TUSB546-DCI immediately exits this mode and enter U0 once far-end termination is detected.

Once in U0 mode, the TUSB546-DCI will redrive all traffic received on UFP and DFP. U0 is the highest power mode of all USB3.1 modes. The TUSB546-DCI remains in U0 mode until electrical idle occurs on both UFP and DFP. Upon detecting electrical idle, the TUSB546-DCI immediately transitions to U1.

The U1 mode is the intermediate mode between U0 mode and U2/U3 mode. In U1 mode, the TUSB546-DCI UFP and DFP receiver termination remains enabled. The UFP and DFP transmitter DC common mode is maintained. The power consumption in U1 is similar to power consumption of U0.

Next to the disconnect mode, the U2/U3 mode is next lowest power state. While in this mode, the TUSB546-DCI periodically performs far-end receiver detection. Anytime the far-end receiver termination is not detected on either UFP or DFP, the TUSB546-DCI leaves the U2/U3 mode and transitions to the Disconnect mode. It also monitors for a valid LFPS. Upon detection of a valid LFPS, the TUSB546-DCI immediately transitions to the U0 mode. In U2/U3 mode, the TUSB546-DCI receiver terminations remain enabled but the TX DC common mode voltage is not maintained.

### 7.4.7 Operation Timing – Power Up

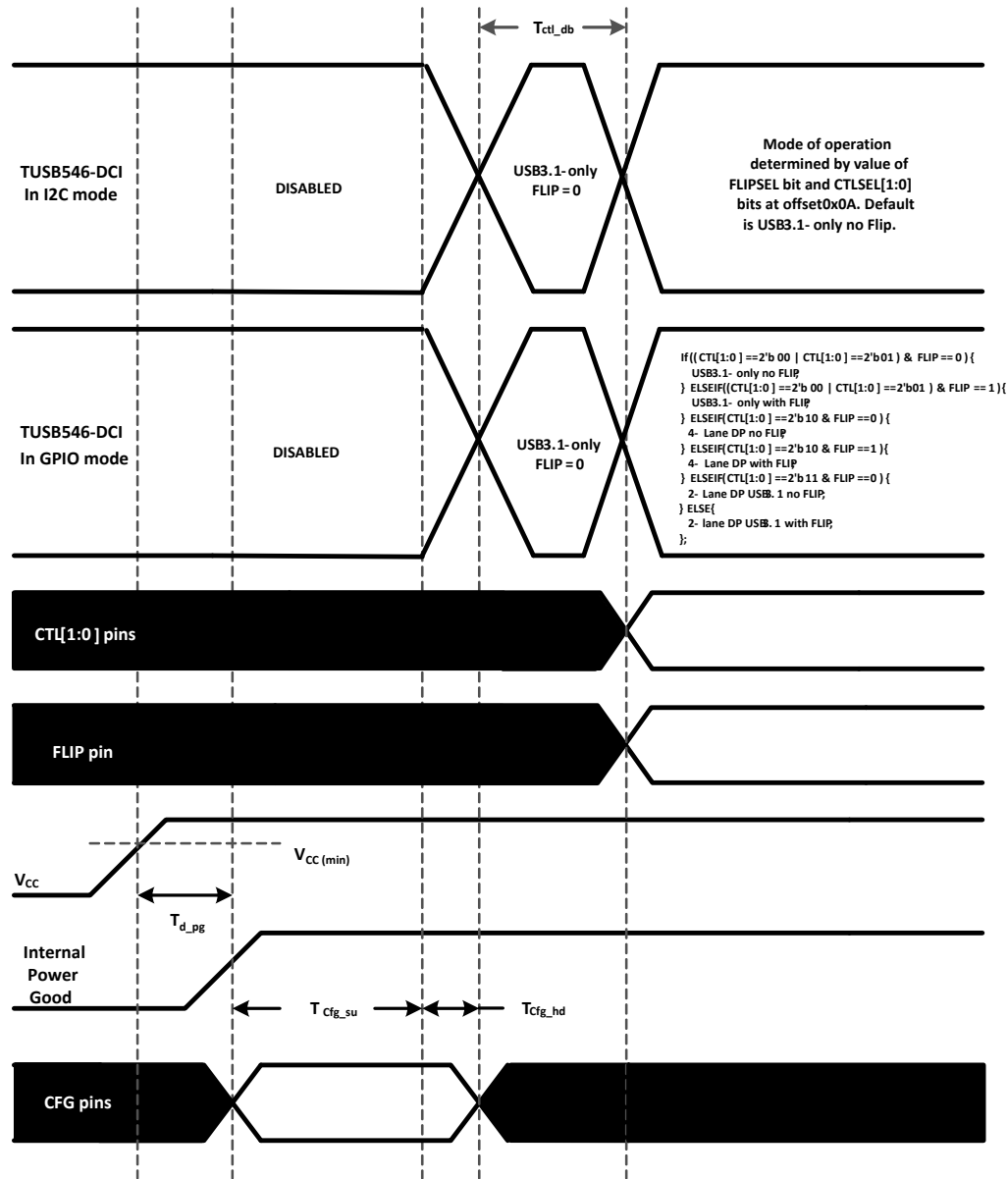

Figure 7-1. Power-Up Timing

Table 7-8. Power-Up Timing<sup>(1) (2)</sup>

PARAMETER		MIN	MAX	UNIT
$t_{d\_pg}$	$V_{CC}$ (minimum) to Internal Power Good asserted high		500	$\mu$ s
$t_{cfg\_su}$	CFG(1) pins setup <sup>(2)</sup>	50		$\mu$ s
$t_{cfg\_hd}$	CFG(1) pins hold	10		$\mu$ s
$t_{CTL\_DB}$	CTL[1:0] and FLIP pin debounce		16	ms
$t_{VCC\_RAMP}$	VCC supply ramp requirement		100	ms

(1) Following pins comprise CFG pins: I2C\_EN, EQ[1:0], SSEQ[1:0], and DPEQ[1:0].  
 (2) Recommend CFG pins are stable when  $V_{CC}$  is at min.

## 7.5 Programming

For further programmability, the TUSB546-DCI can be controlled using I<sup>2</sup>C. The SCL and SDA pins are used for I<sup>2</sup>C clock and I<sup>2</sup>C data respectively.

**Table 7-9. TUSB546-DCI I<sup>2</sup>C Target Address**

DPEQ0/A1 PIN LEVEL	SSEQ0/A0 PIN LEVEL	Bit 7 (MSB)	Bit 6	Bit 5	Bit 4	Bit 3	Bit 2	Bit 1	Bit 0 (W/R)
0	0	1	0	0	0	1	0	0	0/1
0	R	1	0	0	0	1	0	1	0/1
0	F	1	0	0	0	1	1	0	0/1
0	1	1	0	0	0	1	1	1	0/1
R	0	0	1	0	0	0	0	0	0/1
R	R	0	1	0	0	0	0	1	0/1
R	F	0	1	0	0	0	1	0	0/1
R	1	0	1	0	0	0	1	1	0/1
F	0	0	0	1	0	0	0	0	0/1
F	R	0	0	1	0	0	0	1	0/1
F	F	0	0	1	0	0	1	0	0/1
F	1	0	0	1	0	0	1	1	0/1
1	0	0	0	0	1	1	0	0	0/1
1	R	0	0	0	1	1	0	1	0/1
1	F	0	0	0	1	1	1	0	0/1
1	1	0	0	0	1	1	1	1	0/1

The following procedure should be followed to write to TUSB546-DCI I<sup>2</sup>C registers:

1. The controller initiates a write operation by generating a start condition (S), followed by the TUSB546-DCI 7-bit address and a zero-value “W/R” bit to indicate a write cycle.
2. The TUSB546-DCI acknowledges the address cycle.
3. The controller presents the sub-address (I<sup>2</sup>C register within TUSB546-DCI) to be written, consisting of one byte of data, MSB-first.
4. The TUSB546-DCI acknowledges the sub-address cycle.
5. The controller presents the first byte of data to be written to the I<sup>2</sup>C register.
6. The TUSB546-DCI acknowledges the byte transfer.
7. The controller may continue presenting additional bytes of data to be written, with each byte transfer completing with an acknowledge from the TUSB546-DCI.
8. The controller terminates the write operation by generating a stop condition (P).

The following procedure should be followed to read the TUSB546-DCI I<sup>2</sup>C registers:

1. The controller initiates a read operation by generating a start condition (S), followed by the TUSB546-DCI 7-bit address and a one-value “W/R” bit to indicate a read cycle.
2. The TUSB546-DCI acknowledges the address cycle.
3. The TUSB546-DCI transmit the contents of the memory registers MSB-first starting at register 00h or last read sub-address+1. If a write to the T I<sup>2</sup>C register occurred prior to the read, then the TUSB546-DCI shall start at the sub-address specified in the write.
4. The TUSB546-DCI shall wait for either an acknowledge (ACK) or a not-acknowledge (NACK) from the controller after each byte transfer; the I<sup>2</sup>C controller acknowledges reception of each data byte transfer.
5. If an ACK is received, the TUSB546-DCI transmits the next byte of data.
6. The controller terminates the read operation by generating a stop condition (P).

The following procedure should be followed for setting a starting sub-address for I<sup>2</sup>C reads:

1. The controller initiates a write operation by generating a start condition (S), followed by the TUSB546-DCI 7-bit address and a zero-value “W/R” bit to indicate a write cycle.
2. The TUSB546-DCI acknowledges the address cycle.
3. The controller presents the sub-address (I<sup>2</sup>C register within TUSB546-DCI) to be written, consisting of one byte of data, MSB-first.
4. The TUSB546-DCI acknowledges the sub-address cycle.

5. The controller terminates the write operation by generating a stop condition (P).

---

**Note**

If no sub-addressing is included for the read procedure, and reads start at register offset 00h and continue byte by byte through the registers until the I<sup>2</sup>C controller terminates the read operation. If a I<sup>2</sup>C address write occurred prior to the read, then the reads start at the sub-address specified by the address write.

---

**Table 7-10. Register Legend**

ACCESS TAG	NAME	MEANING
R	Read	The field may be read by software
W	Write	The field may be written by software
S	Set	The field may be set by a write of one. Writes of zeros to the field have no effect.
C	Clear	The field may be cleared by a write of one. Write of zero to the field have no effect.
U	Update	Hardware may autonomously update this field.
NA	No Access	Not accessible or not applicable

## 7.6 Register Maps

### 7.6.1 General Register (address = 0x0A) [reset = 00000001]

**Figure 7-2. General Registers**

7	6	5	4	3	2	1	0
Reserved		SWAP_HPDI	EQ_OVERRIDE	HPDI_OVRRI DE	FLIPSEL	CTLSEL[1:0].	
R		R/W	R/W	R/W	R/W	R/W	

LEGEND: R/W = Read/Write; R = Read only; -n = value after reset

**Table 7-11. General Registers**

Bit	Field	Type	Reset	Description
7:6	Reserved.	R	00	Reserved.
5	SWAP_HPDI	R/W	0	0 – HPDI is in default location (Default) 1 – HPDI location is swapped (PIN 23 to PIN 32, or PIN 32 to PIN23).
4	EQ_OVERRIDE	R/W	0	Setting of this field will allow software to use EQ settings from registers instead of value sample from pins. 0 – EQ settings based on sampled state of the EQ pins (SSEQ[1:0], EQ[1:0], and DPEQ[1:0]). 1 – EQ settings based on programmed value of each of the EQ registers
3	HPDI_OVRRI	R/W	0	0 – HPDI IN based on state of HPDI_IN pin (Default) 1 – HPDI_IN high.
2	FLIPSEL	R/W	0	FLIPSEL. Refer to <a href="#">Table 7-5</a> and <a href="#">Table 7-6</a> for this field functionality.
1:0	CTLSEL[1:0].	R/W	01	00 – Disabled. All RX and TX for USB3 and DisplayPort are disabled. 01 – USB3.1 only enabled. (Default) 10 – Four DisplayPort lanes enabled. 11 – Two DisplayPort lanes and one USB3.1

### 7.6.2 DisplayPort Control/Status Registers (address = 0x10) [reset = 00000000]

**Figure 7-3. DisplayPort Control/Status Registers (0x10)**

7	6	5	4	3	2	1	0
DP1EQ_SEL				DP0EQ_SEL			
R/W/U				R/W/U			

LEGEND: R/W = Read/Write; R = Read only; -n = value after reset

**Table 7-12. DisplayPort Control/Status Registers (0x10)**

Bit	Field	Type	Reset	Description
7:4	DP1EQ_SEL	R/W/U	0000	Field selects between 0 to 14dB of EQ for DP lane 1. When EQ_OVERRIDE = 1'b0, this field reflects the sampled state of DPEQ[1:0] pins. When EQ_OVERRIDE = 1'b1, software can change the EQ setting for DP lane 1 based on value written to this field.
3:0	DP0EQ_SEL	R/W/U	0000	Field selects between 0 to 14dB of EQ for DP lane 0. When EQ_OVERRIDE = 1'b0, this field reflects the sampled state of DPEQ[1:0] pins. When EQ_OVERRIDE = 1'b1, software can change the EQ setting for DP lane 0 based on value written to this field.



### 7.6.3 DisplayPort Control/Status Registers (address = 0x11) [reset = 00000000]

Figure 7-4. DisplayPort Control/Status Registers (0x11)

7	6	5	4	3	2	1	0
DP3EQ_SEL				DP2EQ_SEL			
R/W/U				R/W/U			

LEGEND: R/W = Read/Write; R = Read only; -n = value after reset

Table 7-13. DisplayPort Control/Status Registers (0x11)

Bit	Field	Type	Reset	Description
7:4	DP3EQ_SEL	R/W/U	0000	Field selects between 0 to 14dB of EQ for DP lane 3. When EQ_OVERRIDE = 1'b0, this field reflects the sampled state of DPEQ[1:0] pins. When EQ_OVERRIDE = 1'b1, software can change the EQ setting for DP lane 3 based on value written to this field.
3:0	DP2EQ_SEL	R/W/U	0000	Field selects between 0 to 14dB of EQ for DP lane 2. When EQ_OVERRIDE = 1'b0, this field reflects the sampled state of DPEQ[1:0] pins. When EQ_OVERRIDE = 1'b1, software can change the EQ setting for DP lane 2 based on value written to this field.

### 7.6.4 DisplayPort Control/Status Registers (address = 0x12) [reset = 00000000]

Figure 7-5. DisplayPort Control/Status Registers (0x12)

7	6	5	4	3	2	1	0
Reserved	SET_POWER_STATE		LANE_COUNT_SET				
R	RU		RU				

LEGEND: R/W = Read/Write; R = Read only; -n = value after reset

Table 7-14. DisplayPort Control/Status Registers (0x12)

Bit	Field	Type	Reset	Description
7	Reserved	R	0	Reserved
6:5	SET_POWER_STATE	R/U	00	This field represents the snooped value of the AUX write to DPCD address 0x00600. When AUX_SNOOP_DISABLE = 1'b0, the TUSB546-DCI will enable/disable DP lanes based on the snooped value. When AUX_SNOOP_DISABLE = 1'b1, then DP lane enable/disable are determined by state of DPx_DISABLE registers, where x = 0, 1, 2, or 3. This field is reset to 2'b00 by hardware when CTLSEL1 changes from a 1'b1 to a 1'b0.
4:0	LANE_COUNT_SET	R/U	00000	This field represents the snooped value of AUX write to DPCD address 0x00101 register. When AUX_SNOOP_DISABLE = 1'b0, TUSB546-DCI will enable DP lanes specified by the snoop value. Unused DP lanes will be disabled to save power. When AUX_SNOOP_DISABLE = 1'b1, then DP lanes enable/disable are determined by DPx_DISABLE registers, where x = 0, 1, 2, or 3. This field is reset to 0x0 by hardware when CTLSEL1 changes from a 1'b1 to a 1'b0.

## 7.6.5 DisplayPort Control/Status Registers (address = 0x13) [reset = 00000000]

**Figure 7-6. DisplayPort Control/Status Registers (0x13)**

7	6	5	4	3	2	1	0
AUX_SNOOP_DISABLE	Reserved	AUX_SBU_OVR	DP3_DISABLE	DP2_DISABLE	DP1_DISABLE	DP0_DISABLE	
R/W	R	R/W	R/W	R/W	R/W	R/W	R/W

LEGEND: R/W = Read/Write; R = Read only; -n = value after reset

**Table 7-15. DisplayPort Control/Status Registers (0x13)**

Bit	Field	Type	Reset	Description
7	AUX_SNOOP_DISABLE	R/W	0	0 – AUX snoop enabled. (Default) 1 – AUX snoop disabled.
6	Reserved	R	0	Reserved
5:4	AUX_SBU_OVR	R/W	00	This field overrides the AUXp or AUXn to SBU1 or SBU2 connect and disconnect based on CTL1 and FLIP. Changing this field to 1'b1 will allow traffic to pass through AUX to SBU regardless of the state of CTLSEL1 and FLIPSEL register 00 – AUX to SBU connect/disconnect determined by CTLSEL1 and FLIPSEL (Default) 01 – AUXp -> SBU1 and AUXn -> SBU2 connection always enabled. AUXp -> SBU2 and AUXn -> SBU1 connection always enabled. 11 = AUX to SBU open.
3	DP3_DISABLE	R/W	0	When AUX_SNOOP_DISABLE = 1'b1, this field can be used to enable or disable DP lane 3. When AUX_SNOOP_DISABLE = 1'b0, changes to this field will have no effect on lane 3 functionality. 0 – DP Lane 3 Enabled (default) 1 – DP Lane 3 Disabled.
2	DP2_DISABLE	R/W	0	When AUX_SNOOP_DISABLE = 1'b1, this field can be used to enable or disable DP lane 2. When AUX_SNOOP_DISABLE = 1'b0, changes to this field will have no effect on lane 2 functionality. 0 – DP Lane 2 Enabled (default) 1 – DP Lane 2 Disabled.
1	DP1_DISABLE	R/W	0	When AUX_SNOOP_DISABLE = 1'b1, this field can be used to enable or disable DP lane 1. When AUX_SNOOP_DISABLE = 1'b0, changes to this field will have no effect on lane 1 functionality. 0 – DP Lane 1 Enabled (default) 1 – DP Lane 1 Disabled.
0	DP0_DISABLE	R/W	0	DISABLE. When AUX_SNOOP_DISABLE = 1'b1, this field can be used to enable or disable DP lane 0. When AUX_SNOOP_DISABLE = 1'b0, changes to this field will have no effect on lane 0 functionality. 0 – DP Lane 0 Enabled (default) 1 – DP Lane 0 Disabled.

### 7.6.6 USB3.1 Control/Status Registers (address = 0x20) [reset = 00000000]

**Figure 7-7. USB3.1 Control/Status Registers (0x20)**

7	6	5	4	3	2	1	0
EQ2_SEL				EQ1_SEL			
R/W/U				R/W/U			

LEGEND: R/W = Read/Write; R = Read only; -n = value after reset

**Table 7-16. USB3.1 Control/Status Registers (0x20)**

Bit	Field	Type	Reset	Description
7:4	EQ2_SEL	R/W/U	0000	Field selects between 0 to 11 dB of EQ for USB3.1 RX2 receiver. When EQ_OVERRIDE = 1'b0, this field reflects the sampled state of EQ[1:0] pins. When EQ_OVERRIDE = 1'b1, software can change the EQ setting for USB3.1 RX2 receiver based on value written to this field.
3:0	EQ1_SEL	R/W/U	0000	Field selects between 0 to 11 dB of EQ for USB3.1 RX1 receiver. When EQ_OVERRIDE = 1'b0, this field reflects the sampled state of EQ[1:0] pins. When EQ_OVERRIDE = 1'b1, software can change the EQ setting for USB3.1 RX1 receiver based on value written to this field.

### 7.6.7 USB3.1 Control/Status Registers (address = 0x21) [reset = 00000000]

**Figure 7-8. USB3.1 Control/Status Registers (0x21)**

7	6	5	4	3	2	1	0
Reserved				SSEQ_SEL			
R				R/W/U			

LEGEND: R/W = Read/Write; R = Read only; -n = value after reset

**Table 7-17. USB3.1 Control/Status Registers (0x21)**

Bit	Field	Type	Reset	Description
7:4	Reserved	R	0000	Reserved
3:0	SSEQ_SEL	R/W/U	0000	Field selects between 0 to 9 dB of EQ for USB3.1 SSTXP/N receiver. When EQ_OVERRIDE = 1'b0, this field reflects the sampled state of SSEQ[1:0] pins. When EQ_OVERRIDE = 1'b1, software can change the EQ setting for USB3.1 SSTXP/N receiver based on value written to this field.

### 7.6.8 USB3.1 Control/Status Registers (address = 0x22) [reset = 0000100]

**Figure 7-9. USB3.1 Control/Status Registers (0x22)**

7	6	5	4	3	2	1	0
CM_ACTIVE	LFPS_EQ	U2U3_LFPS_D EBOUNCE	DISABLE_U2U 3_RXDET	DFP_RXDET_INTERVAL		USB3_COMPLIANCE_CTRL	
R/U	R/W	R/W	R/W	R/W		R/W	

LEGEND: R/W = Read/Write; R = Read only; -n = value after reset

**Table 7-18. USB3.1 Control/Status Registers (0x22)**

Bit	Field	Type	Reset	Description
7	CM_ACTIVE	R/U	0	0 – device not in USB 3.1 compliance mode. (Default) 1 – device in USB 3.1 compliance mode
6	LFPS_EQ	R/W	0	Controls whether settings of EQ based on EQ1_SEL, EQ2_SEL and SSEQ_SEL applies to received LFPS signal. 0 – EQ set to zero when receiving LFPS (default) 1 – EQ set to EQ1_SEL, EQ2_SEL, and SSEQ_SEL when receiving LFPS.
5	U2U3_LFPS_DEBOUNCE	R/W	0	0 – No debounce of LFPS before U2/U3 exit. (Default) 1 – 200 $\mu$ s debounce of LFPS before U2/U3 exit.
4	DISABLE_U2U3_RXDET	R/W	0	0 – Rx.Detect in U2/U3 enabled. (Default) 1 – Rx.Detect in U2/U3 disabled.
3:2	DFP_RXDET_INTERVAL	R/W	01	This field controls the Rx.Detect interval for the Downstream facing port (TX1P/N and TX2P/N). 00 – 8 ms 01 – 12 ms (default) 10 – 48 ms 11 – 96 ms
1:0	USB3_COMPLIANCE_CTRL	R/W	00	00 – FSM determined compliance mode. (Default) 01 – Compliance Mode enabled in DFP direction (SSTX -> TX1/TX2) 10 – Compliance Mode enabled in UFP direction (RX1/RX2 -> SSRX) 11 – Compliance Mode Disabled.

## 8 Application and Implementation

### Note

Information in the following applications sections is not part of the TI component specification, and TI does not warrant its accuracy or completeness. TI's customers are responsible for determining suitability of components for their purposes, as well as validating and testing their design implementation to confirm system functionality.

### 8.1 Application Information

The TUSB546-DCI is a linear redriver designed specifically to compensation for intersymbol interference (ISI) jitter caused by signal attenuation through a passive medium like PCB traces and cables. Because the TUSB546-DCI has four independent DisplayPort 1.4 inputs, one upstream facing USB 3.1 Gen1 input, and two downstream facing USB 3.1 Gen1 inputs, it can be optimized to correct ISI on all those seven inputs through 16 different equalization choices. Placing the TUSB546-DCI between a USB3.1 Host/DisplayPort 1.4 GPU and a USB3.1 Type-C receptacle can correct signal integrity issues resulting in a more robust system.

### 8.2 Typical Application

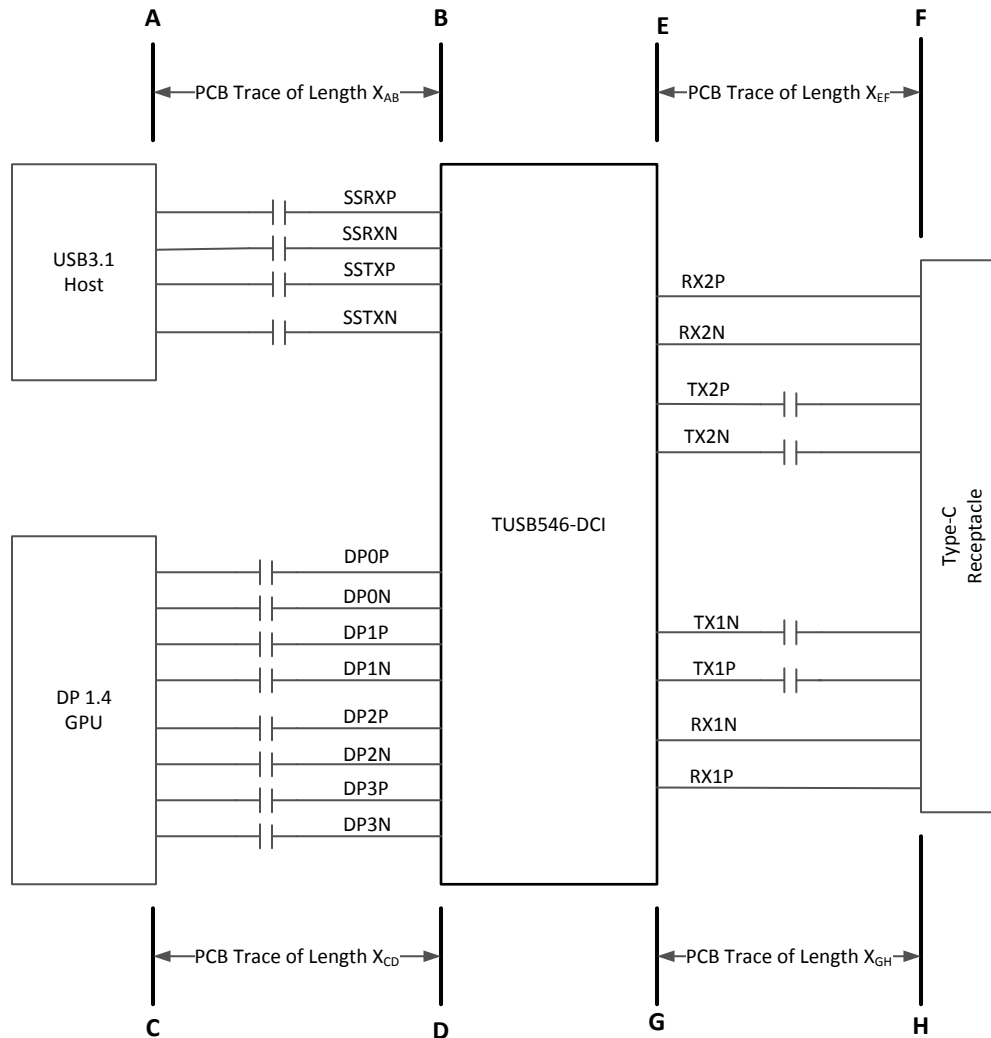

Copyright © 2016, Texas Instruments Incorporated

Figure 8-1. TUSB546-DCI in a Host Application

## 8.2.1 Design Requirements

For this design example, use the parameters shown in [Table 8-1](#).

**Table 8-1. Design Parameters**

PARAMETER	VALUE
A to B PCB trace length, $X_{AB}$	12 inches
C to D PCB trace length, $X_{CD}$	12 inches
E to F PCB trace length, $X_{EF}$	2 inches
G to H PCB trace length, $X_{GH}$	2 inches
PCB trace width	4 mils
AC-coupling capacitor (75 nF to 265 nF)	100 nF
VCC supply (3 V to 3.6 V)	3.3 V
I2C Mode or GPIO Mode	I2C Mode. (I2C_EN pin != "0")
1.8V or 3.3V I2C Interface	3.3V I2C. Pull-up the I2C_EN pin to 3.3V with a 1K ohm resistor.

## 8.2.2 Detailed Design Procedure

A typical usage of the TUSB546-DCI device is shown in [Figure 8-2](#). The device can be controlled either through its GPIO pins or through its I<sup>2</sup>C interface. In the example shown below, a Type-C PD controller is used to configure the device through the I<sup>2</sup>C interface. When configured for I2C mode, pins 29 (RSVD1) and 32 (RSVD2) can be left unconnected. In I2C mode, the equalization settings for each receiver can be independently controlled through I2C registers. For this reason, all of the equalization pins (EQ[1:0], SSEQ[1:0], and DPEQ[1:0]) can be left unconnected. If these pins are left unconnected, the TUSB546-DCI 7-bit I2C target address will be 0x12 because both DPEQ/A1 and SSEQ0/A0 will be at pin level "F". If a different I2C target address is desired, DPEQ/A1 and SSEQ0/A0 pins should be set to a level which produces the desired I2C target address.

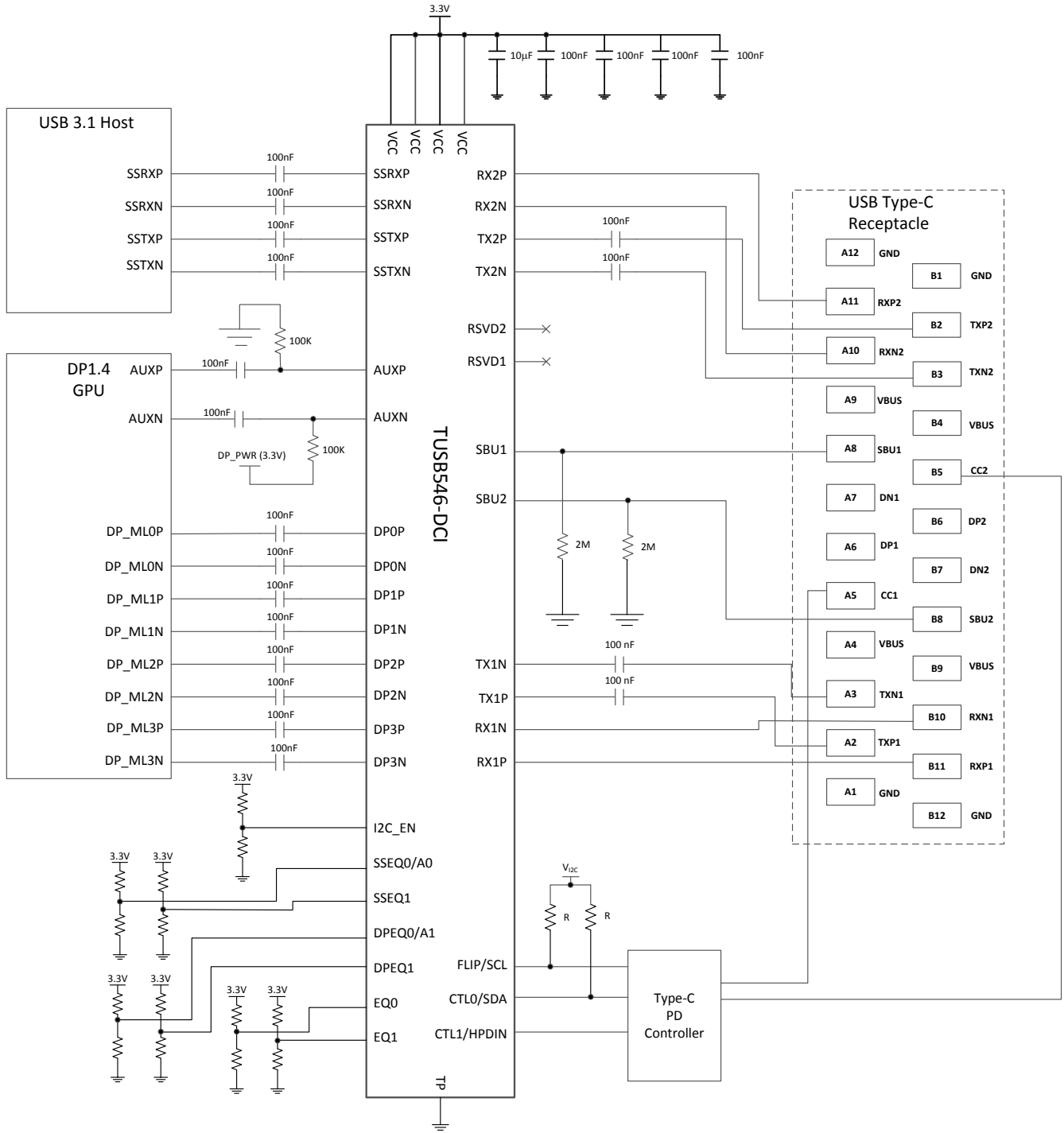

Copyright © 2016, Texas Instruments Incorporated

**Figure 8-2. Application Circuit**

### 8.2.3 Application Curve

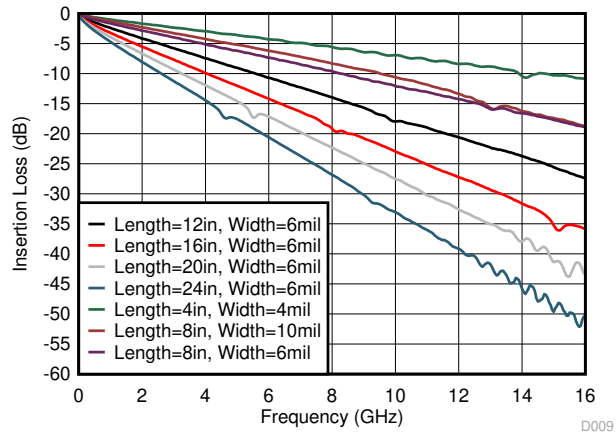

**Figure 8-3. Insertion Loss of FR4 PCB Traces**



### 8.3 System Examples

#### 8.3.1 USB 3.1 Only

The TUSB546-DCI is in USB3.1 only when the CTL1 pin is low and CTL0 pin is high.

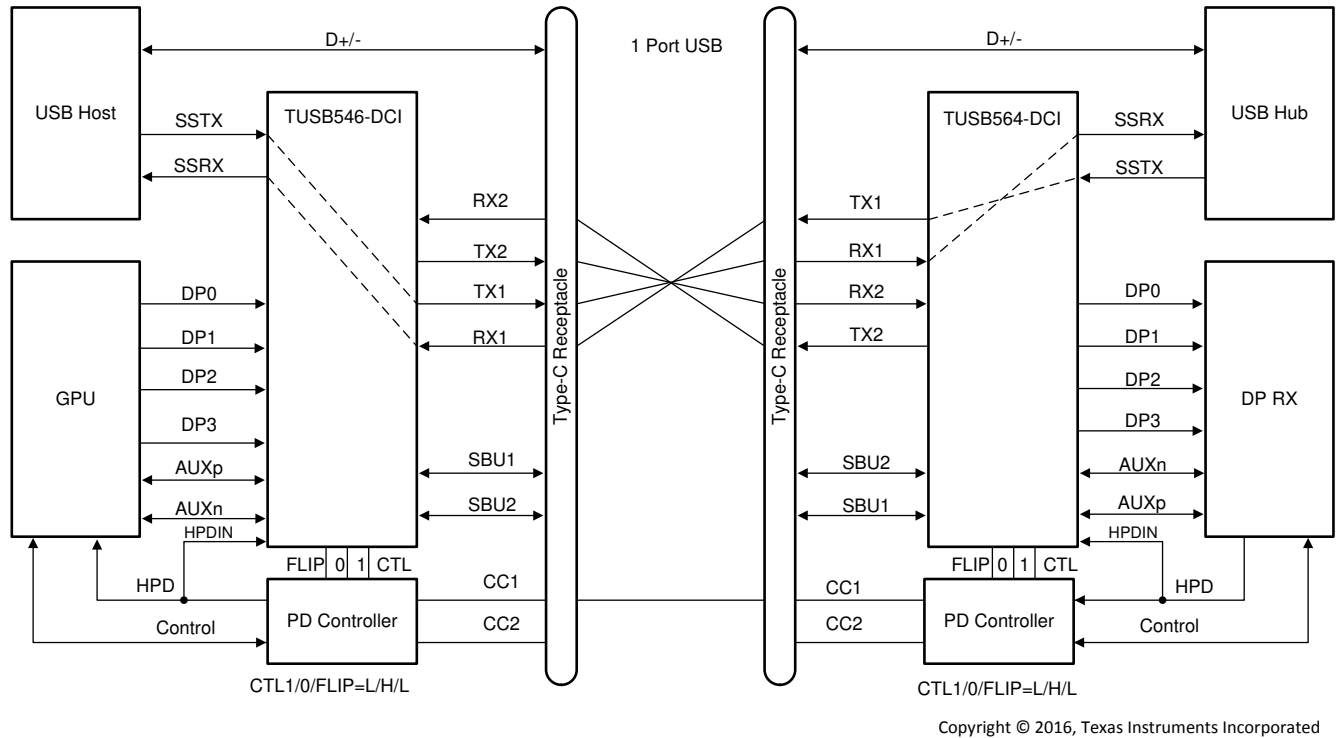

Figure 8-4. USB3.1 Only – No Flip (CTL1 = L, CTL0 = H, FLIP = L)

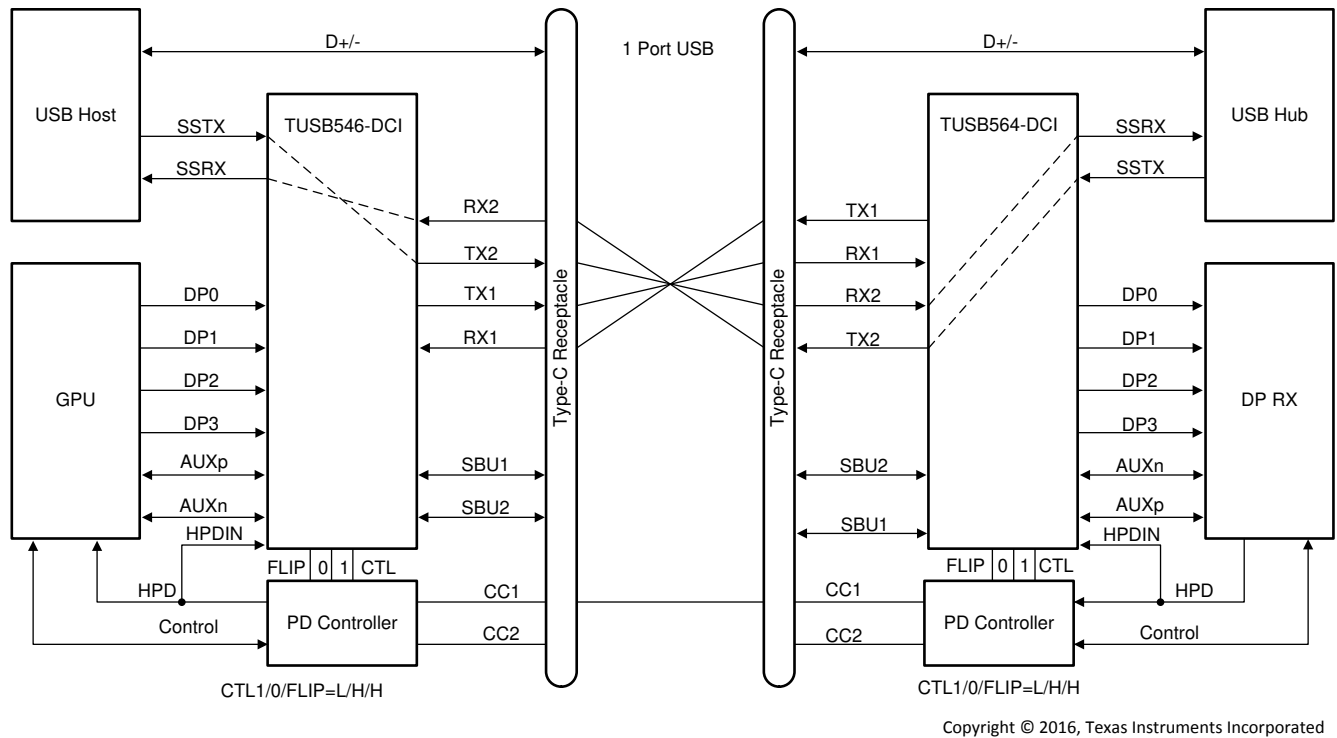
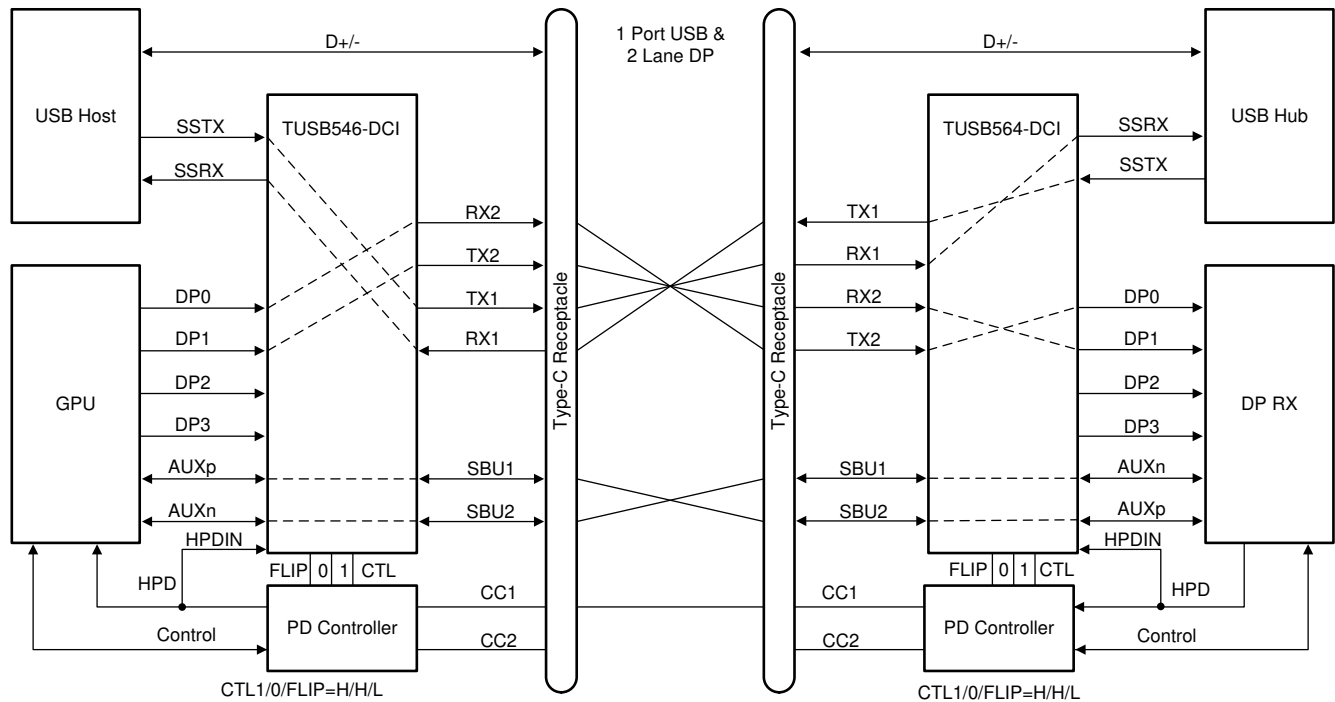

Figure 8-5. USB3.1 Only – With Flip (CTL1 = L, CTL0 = H, FLIP = H)

### 8.3.2 USB 3.1 and 2 Lanes of DisplayPort

The TUSB546-DCI operates in USB3.1 and 2 Lanes of DisplayPort mode when the CTL1 pin is high and CTL0 pin is high.



Copyright © 2016, Texas Instruments Incorporated

**Figure 8-6. USB3.1 + 2 Lane DP – No Flip (CTL1 = H, CTL0 = H, FLIP = L)**

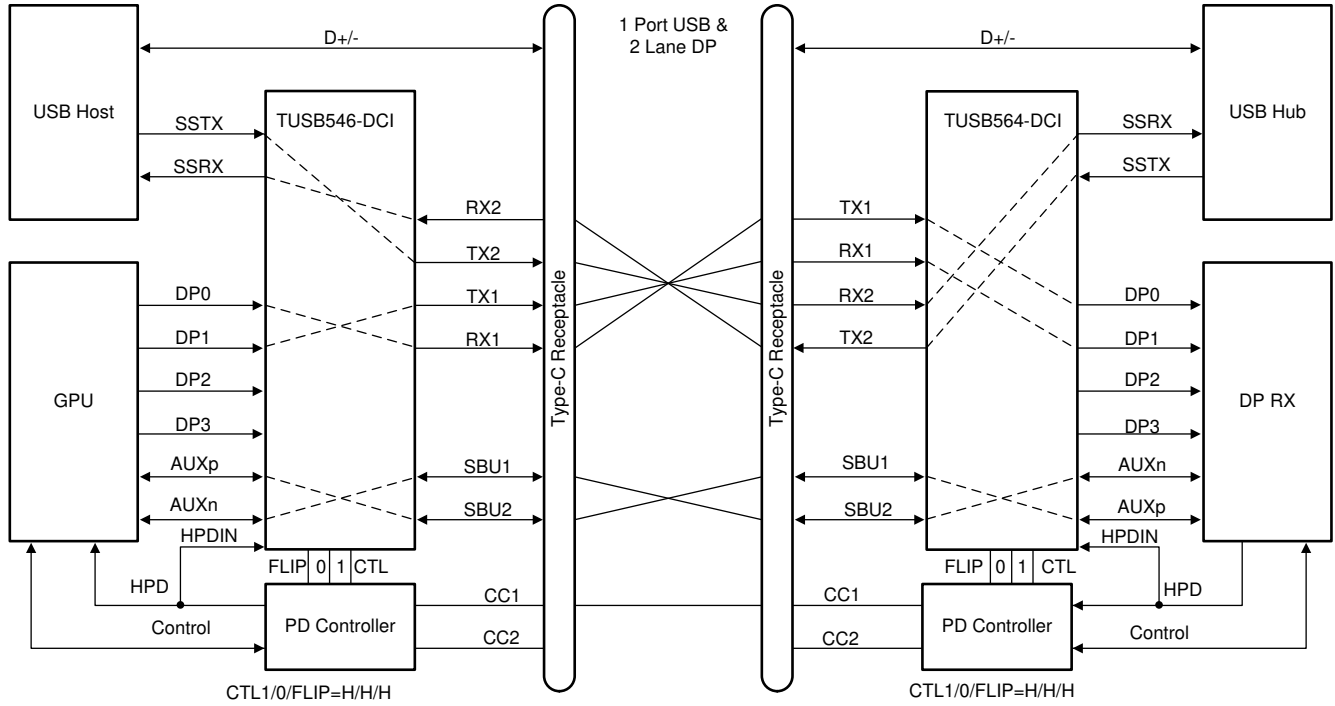

Copyright © 2016, Texas Instruments Incorporated

**Figure 8-7. USB 3.1 + 2 Lane DP – Flip (CTL1 = H, CTL0 = H, FLIP = H)**

### 8.3.3 DisplayPort Only

The TUSB546-DCI operates in 4 Lanes of DisplayPort only mode when the CTL1 pin is high and CTL0 pin is low.

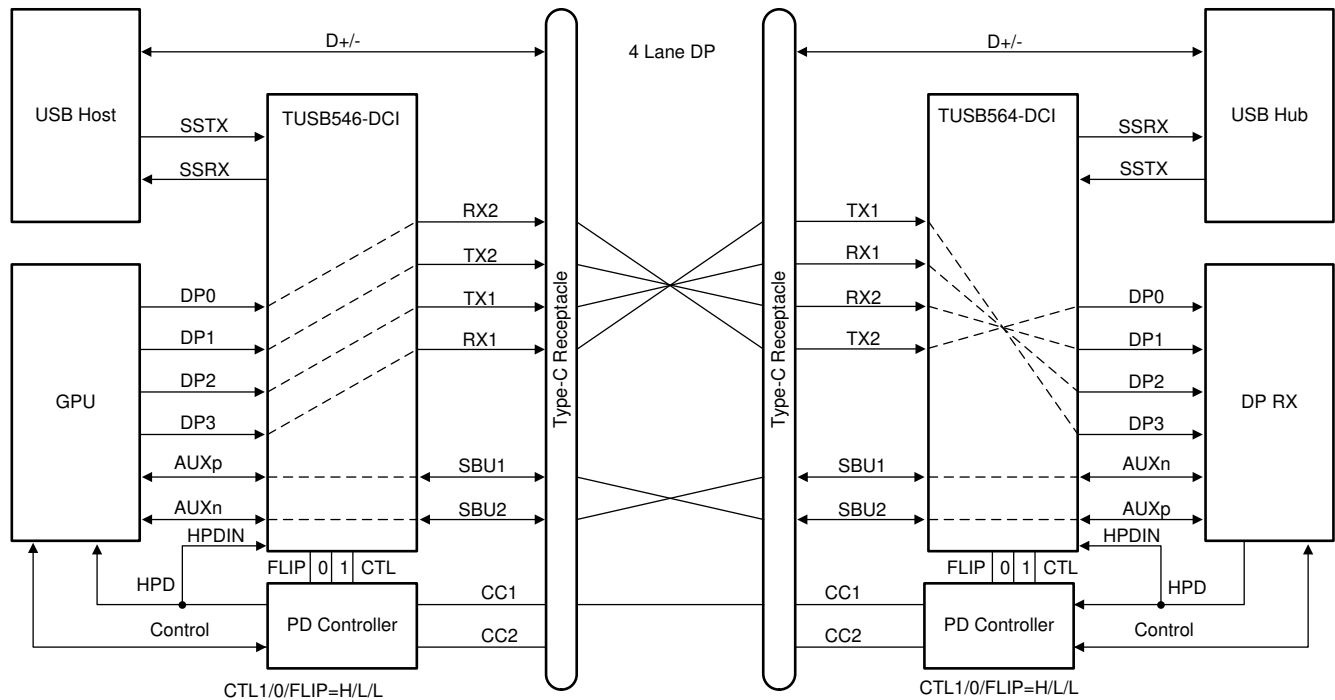

Copyright © 2016, Texas Instruments Incorporated

**Figure 8-8. Four Lane DP – No Flip (CTL1 = H, CTL0 = L, FLIP = L)**

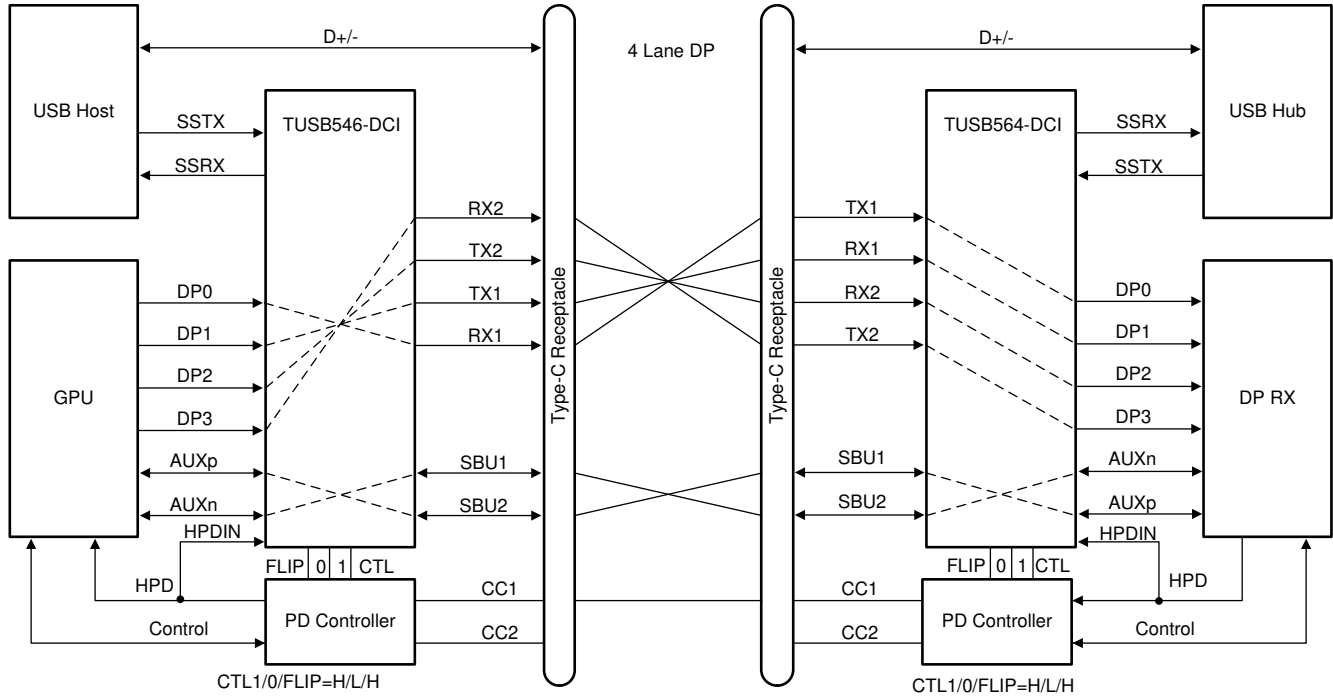

Copyright © 2016, Texas Instruments Incorporated

Figure 8-9. Four Lane DP – With Flip (CTL1 = H, CTL0 = L, FLIP = H)

## 8.4 Power Supply Recommendations

The TUSB546-DCI is designed to operate with a 3.3-V power supply. Levels above those listed in the [Section 6.1](#) table should not be used. If using a higher voltage system power supply, a voltage regulator can be used to step down to 3.3 V. Decoupling capacitors should be used to reduce noise and improve power supply integrity. A 0.1- $\mu$ F capacitor should be used on each power pin.

## 8.5 Layout

### 8.5.1 Layout Guidelines

1. RXP/N and TXP/N pairs should be routed with controlled 90- $\Omega$  differential impedance ( $\pm 15\%$ ).
2. Keep away from other high speed signals.
3. Intra-pair routing should be kept to within 2 mils.
4. Length matching should be near the location of mismatch.
5. Each pair should be separated at least by 3 times the signal trace width.
6. The use of bends in differential traces should be kept to a minimum. When bends are used, the number of left and right bends should be as equal as possible and the angle of the bend should be  $\geq 135$  degrees. This will minimize any length mismatch causes by the bends and therefore minimize the impact bends have on EMI.
7. Route all differential pairs on the same of layer.
8. The number of VIAS should be kept to a minimum. It is recommended to keep the VIAS count to 2 or less.
9. Keep traces on layers adjacent to ground plane.
10. Do NOT route differential pairs over any plane split.
11. Adding Test points will cause impedance discontinuity, and therefore, negatively impact signal performance. If test points are used, they should be placed in series and symmetrically. They must not be placed in a manner that causes a stub on the differential pair.

### 8.5.2 Layout Example

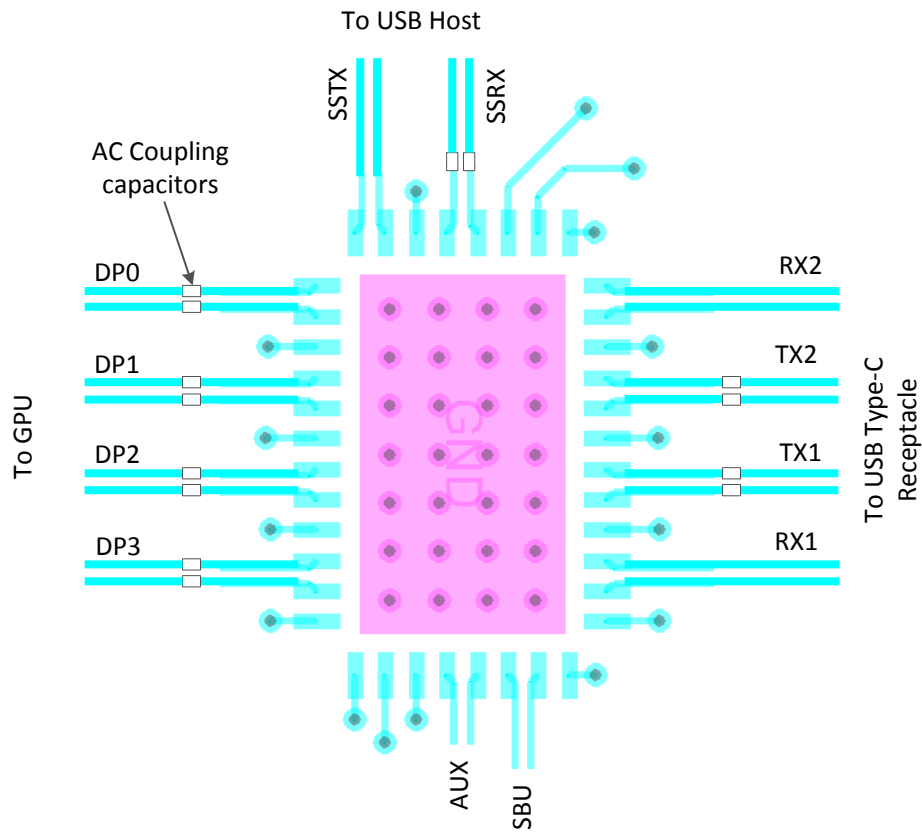

Figure 8-10. Layout Example

## 9 Device and Documentation Support

### 9.1 Receiving Notification of Documentation Updates

To receive notification of documentation updates, navigate to the device product folder on [ti.com](http://ti.com). Click on *Subscribe to updates* to register and receive a weekly digest of any product information that has changed. For change details, review the revision history included in any revised document.

### 9.2 Support Resources

TI E2E™ [support forums](#) are an engineer's go-to source for fast, verified answers and design help — straight from the experts. Search existing answers or ask your own question to get the quick design help you need.

Linked content is provided "AS IS" by the respective contributors. They do not constitute TI specifications and do not necessarily reflect TI's views; see TI's [Terms of Use](#).

### 9.3 Trademarks

Type-C™ is a trademark of USB Implementers Forum.

TI E2E™ is a trademark of Texas Instruments.

All trademarks are the property of their respective owners.

### 9.4 Electrostatic Discharge Caution



This integrated circuit can be damaged by ESD. Texas Instruments recommends that all integrated circuits be handled with appropriate precautions. Failure to observe proper handling and installation procedures can cause damage.

ESD damage can range from subtle performance degradation to complete device failure. Precision integrated circuits may be more susceptible to damage because very small parametric changes could cause the device not to meet its published specifications.

## 9.5 Glossary

[TI Glossary](#) This glossary lists and explains terms, acronyms, and definitions.

## 10 Mechanical, Packaging, and Orderable Information

The following pages include mechanical, packaging, and orderable information. This information is the most current data available for the designated devices. This data is subject to change without notice and revision of this document. For browser-based versions of this data sheet, refer to the left-hand navigation.

**PACKAGING INFORMATION**

Orderable Device	Status (1)	Package Type	Package Drawing	Pins	Package Qty	Eco Plan (2)	Lead finish/ Ball material (6)	MSL Peak Temp (3)	Op Temp (°C)	Device Marking (4/5)	Samples
TUSB546-DCIRNQR	ACTIVE	WQFN	RNQ	40	3000	RoHS & Green	NIPDAU	Level-1-260C-UNLIM	0 to 70	TUSB546D	<a href="#">Samples</a>
TUSB546-DCIRNQT	ACTIVE	WQFN	RNQ	40	250	RoHS & Green	NIPDAU	Level-1-260C-UNLIM	0 to 70	TUSB546D	<a href="#">Samples</a>

(1) The marketing status values are defined as follows:

**ACTIVE:** Product device recommended for new designs.

**LIFEBUY:** TI has announced that the device will be discontinued, and a lifetime-buy period is in effect.

**NRND:** Not recommended for new designs. Device is in production to support existing customers, but TI does not recommend using this part in a new design.

**PREVIEW:** Device has been announced but is not in production. Samples may or may not be available.

**OBSOLETE:** TI has discontinued the production of the device.

(2) **RoHS:** TI defines "RoHS" to mean semiconductor products that are compliant with the current EU RoHS requirements for all 10 RoHS substances, including the requirement that RoHS substance do not exceed 0.1% by weight in homogeneous materials. Where designed to be soldered at high temperatures, "RoHS" products are suitable for use in specified lead-free processes. TI may reference these types of products as "Pb-Free".

**RoHS Exempt:** TI defines "RoHS Exempt" to mean products that contain lead but are compliant with EU RoHS pursuant to a specific EU RoHS exemption.

**Green:** TI defines "Green" to mean the content of Chlorine (Cl) and Bromine (Br) based flame retardants meet JS709B low halogen requirements of <=1000ppm threshold. Antimony trioxide based flame retardants must also meet the <=1000ppm threshold requirement.

(3) MSL, Peak Temp. - The Moisture Sensitivity Level rating according to the JEDEC industry standard classifications, and peak solder temperature.

(4) There may be additional marking, which relates to the logo, the lot trace code information, or the environmental category on the device.

(5) Multiple Device Markings will be inside parentheses. Only one Device Marking contained in parentheses and separated by a "~" will appear on a device. If a line is indented then it is a continuation of the previous line and the two combined represent the entire Device Marking for that device.

(6) Lead finish/Ball material - Orderable Devices may have multiple material finish options. Finish options are separated by a vertical ruled line. Lead finish/Ball material values may wrap to two lines if the finish value exceeds the maximum column width.

**Important Information and Disclaimer:**The information provided on this page represents TI's knowledge and belief as of the date that it is provided. TI bases its knowledge and belief on information provided by third parties, and makes no representation or warranty as to the accuracy of such information. Efforts are underway to better integrate information from third parties. TI has taken and continues to take reasonable steps to provide representative and accurate information but may not have conducted destructive testing or chemical analysis on incoming materials and chemicals. TI and TI suppliers consider certain information to be proprietary, and thus CAS numbers and other limited information may not be available for release.

In no event shall TI's liability arising out of such information exceed the total purchase price of the TI part(s) at issue in this document sold by TI to Customer on an annual basis.



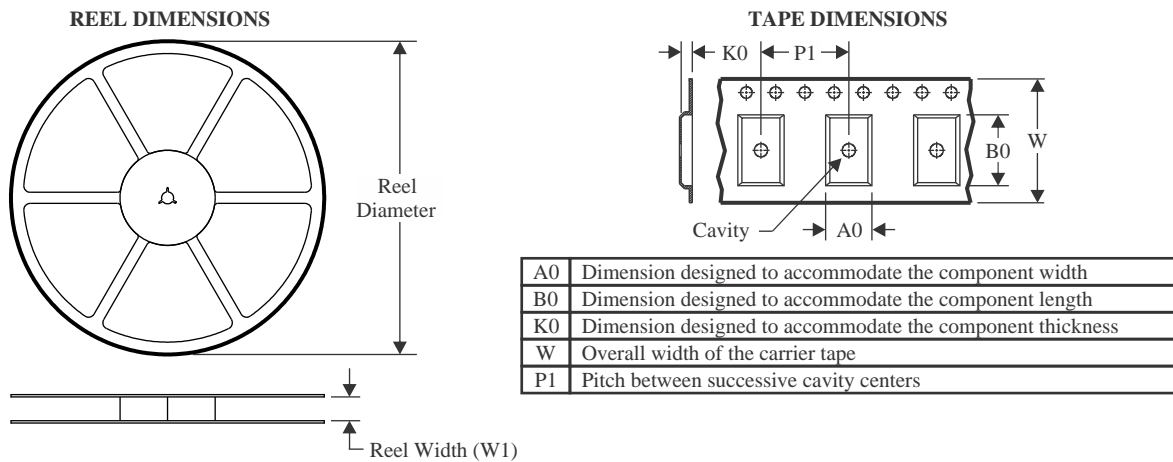

**TAPE AND REEL INFORMATION**

**QUADRANT ASSIGNMENTS FOR PIN 1 ORIENTATION IN TAPE**

\*All dimensions are nominal

Device	Package Type	Package Drawing	Pins	SPQ	Reel Diameter (mm)	Reel Width W1 (mm)	A0 (mm)	B0 (mm)	K0 (mm)	P1 (mm)	W (mm)	Pin1 Quadrant
TUSB546-DCIRNQR	WQFN	RNQ	40	3000	330.0	12.4	4.3	6.3	1.1	8.0	12.0	Q2
TUSB546-DCIRNQT	WQFN	RNQ	40	250	180.0	12.4	4.3	6.3	1.1	8.0	12.0	Q2

**TAPE AND REEL BOX DIMENSIONS**

\*All dimensions are nominal

Device	Package Type	Package Drawing	Pins	SPQ	Length (mm)	Width (mm)	Height (mm)
TUSB546-DCIRNQR	WQFN	RNQ	40	3000	367.0	367.0	35.0
TUSB546-DCIRNQT	WQFN	RNQ	40	250	210.0	185.0	35.0

# RNQ0040A



# PACKAGE OUTLINE

WQFN - 0.8 mm max height

PLASTIC QUAD FLATPACK - NO LEAD

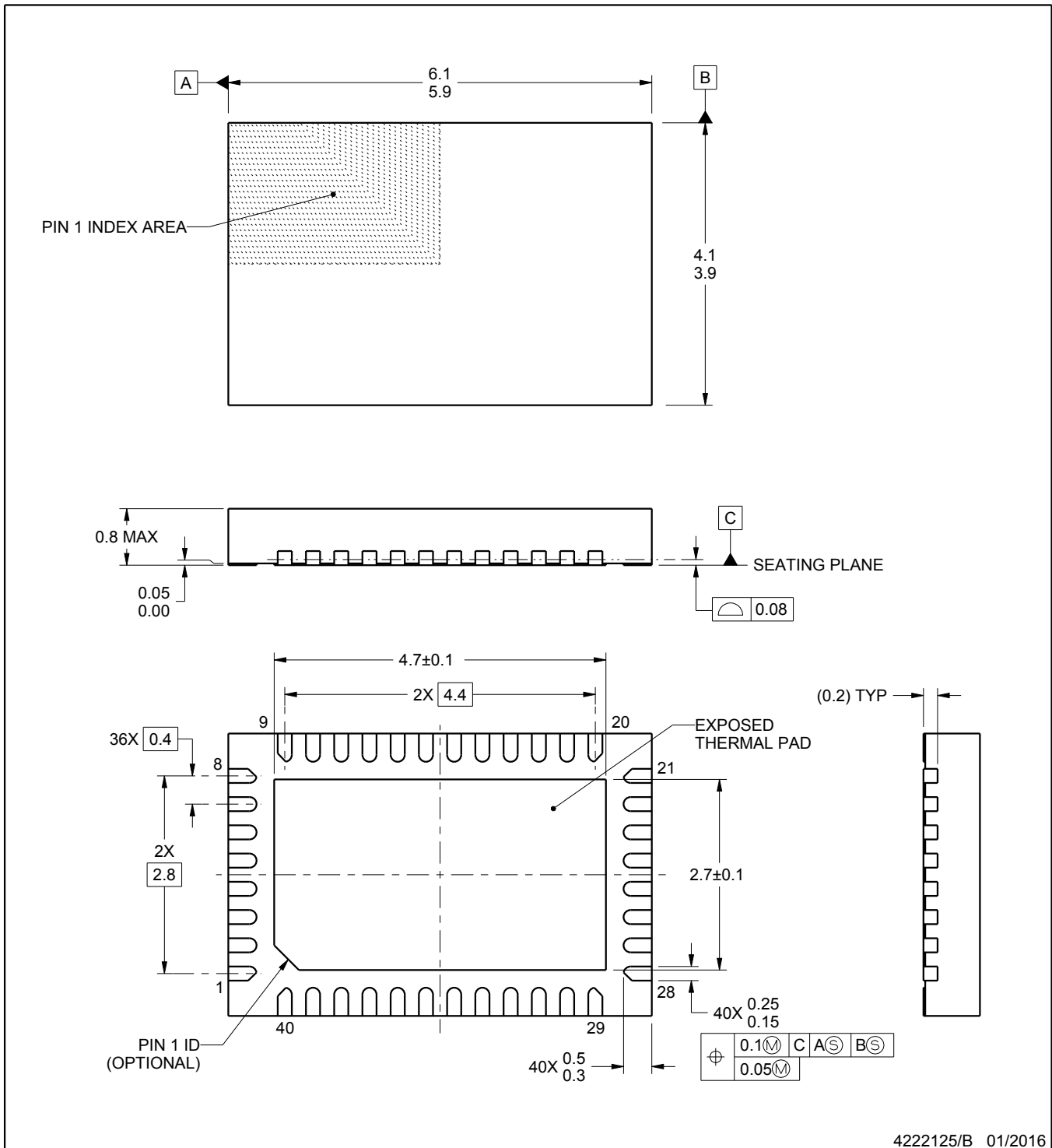

4222125/B 01/2016

**NOTES:**

1. All linear dimensions are in millimeters. Any dimensions in parenthesis are for reference only. Dimensioning and tolerancing per ASME Y14.5M.
2. This drawing is subject to change without notice.
3. The package thermal pad must be soldered to the printed circuit board for thermal and mechanical performance.

# EXAMPLE BOARD LAYOUT

**RNQ0040A**

**WQFN - 0.8 mm max height**

PLASTIC QUAD FLATPACK - NO LEAD

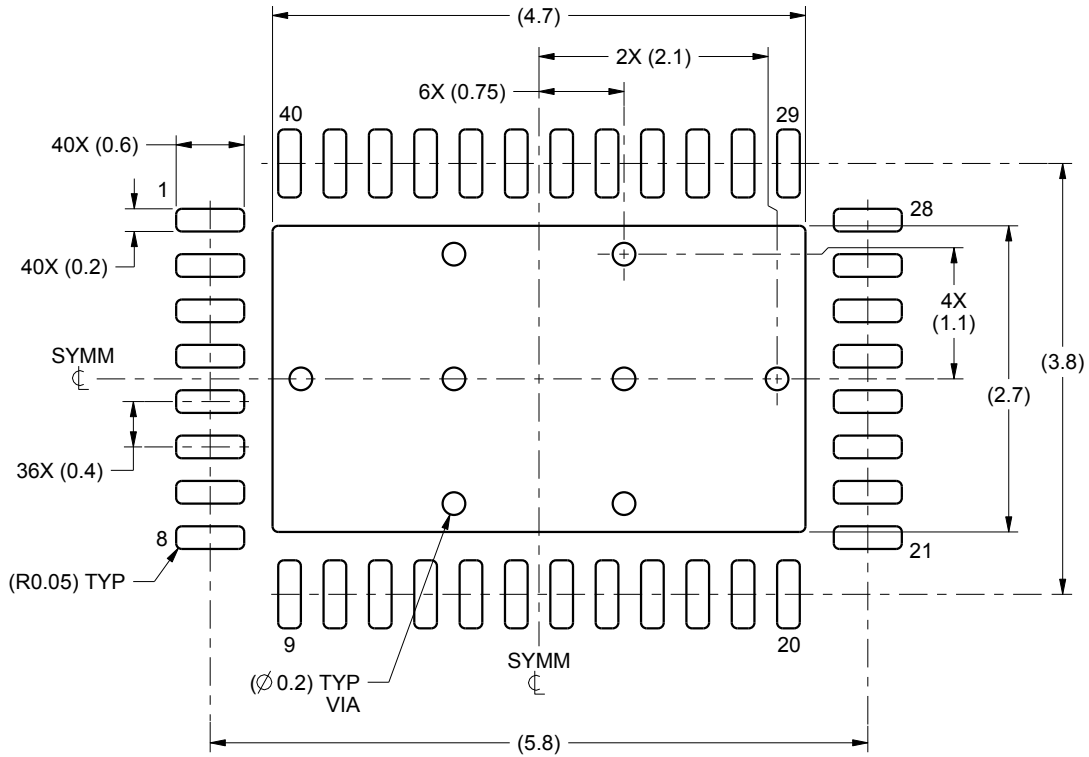

LAND PATTERN EXAMPLE  
SCALE:15X

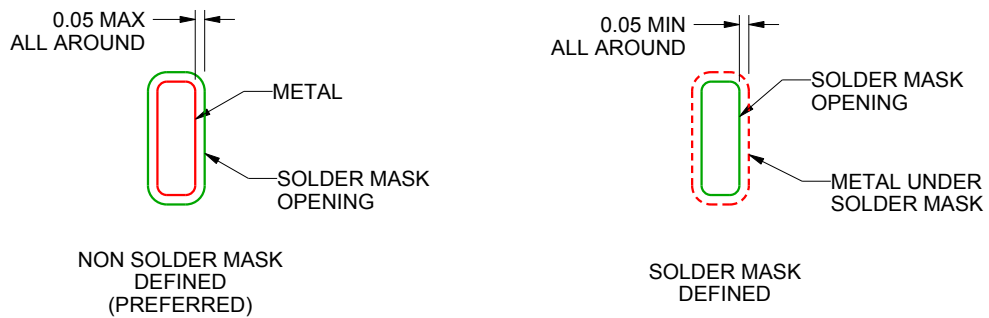

SOLDER MASK DETAILS

4222125/B 01/2016

NOTES: (continued)

4. This package is designed to be soldered to a thermal pad on the board. For more information, see Texas Instruments literature number SLUA271 ([www.ti.com/lit/slua271](http://www.ti.com/lit/slua271)).

# EXAMPLE STENCIL DESIGN

RNQ0040A

WQFN - 0.8 mm max height

PLASTIC QUAD FLATPACK - NO LEAD

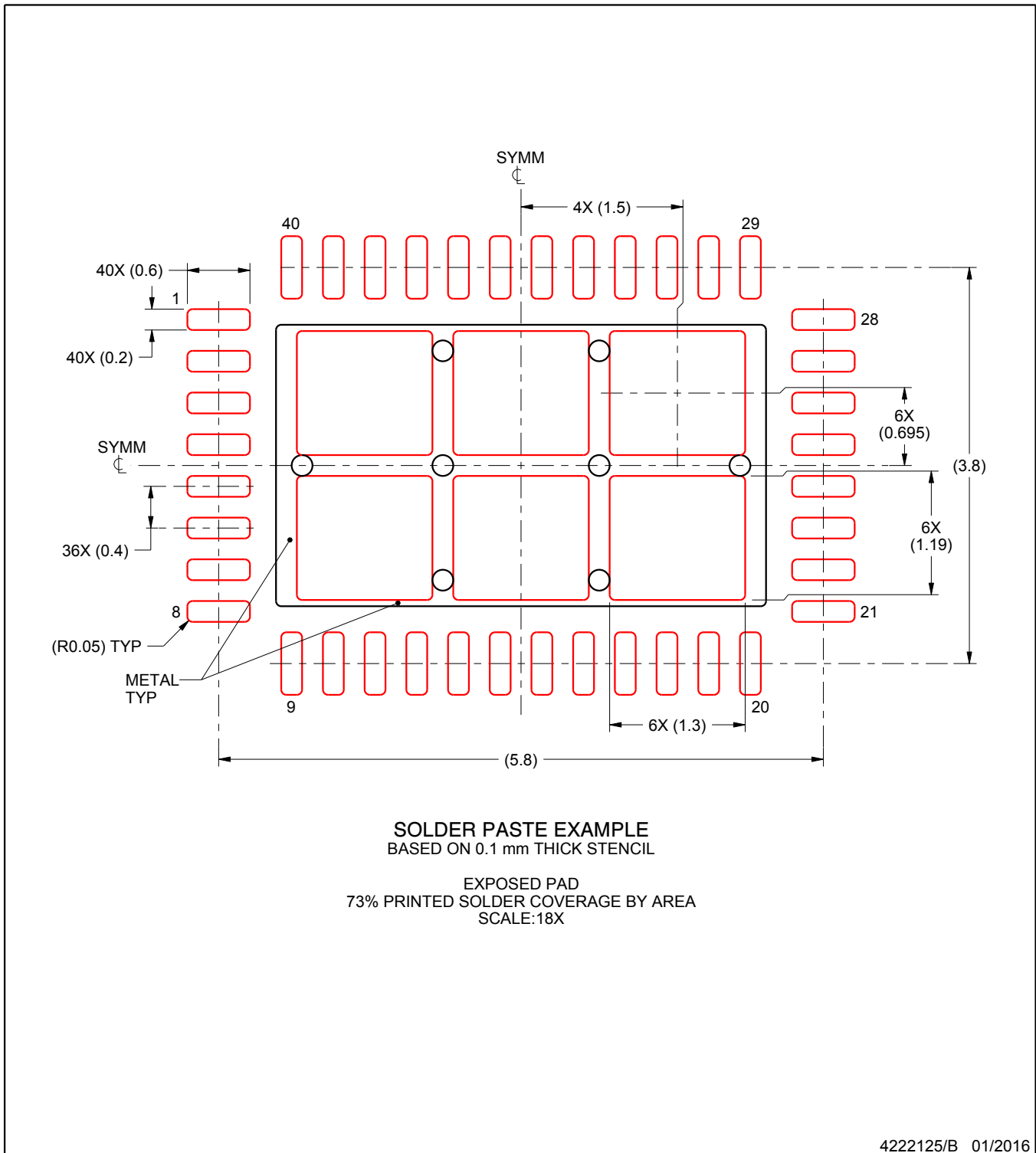

NOTES: (continued)

5. Laser cutting apertures with trapezoidal walls and rounded corners may offer better paste release. IPC-7525 may have alternate design recommendations.

## IMPORTANT NOTICE AND DISCLAIMER

TI PROVIDES TECHNICAL AND RELIABILITY DATA (INCLUDING DATA SHEETS), DESIGN RESOURCES (INCLUDING REFERENCE DESIGNS), APPLICATION OR OTHER DESIGN ADVICE, WEB TOOLS, SAFETY INFORMATION, AND OTHER RESOURCES "AS IS" AND WITH ALL FAULTS, AND DISCLAIMS ALL WARRANTIES, EXPRESS AND IMPLIED, INCLUDING WITHOUT LIMITATION ANY IMPLIED WARRANTIES OF MERCHANTABILITY, FITNESS FOR A PARTICULAR PURPOSE OR NON-INFRINGEMENT OF THIRD PARTY INTELLECTUAL PROPERTY RIGHTS.

These resources are intended for skilled developers designing with TI products. You are solely responsible for (1) selecting the appropriate TI products for your application, (2) designing, validating and testing your application, and (3) ensuring your application meets applicable standards, and any other safety, security, regulatory or other requirements.

These resources are subject to change without notice. TI grants you permission to use these resources only for development of an application that uses the TI products described in the resource. Other reproduction and display of these resources is prohibited. No license is granted to any other TI intellectual property right or to any third party intellectual property right. TI disclaims responsibility for, and you will fully indemnify TI and its representatives against, any claims, damages, costs, losses, and liabilities arising out of your use of these resources.

TI's products are provided subject to [TI's Terms of Sale](#) or other applicable terms available either on [ti.com](https://www.ti.com) or provided in conjunction with such TI products. TI's provision of these resources does not expand or otherwise alter TI's applicable warranties or warranty disclaimers for TI products.

TI objects to and rejects any additional or different terms you may have proposed.

Mailing Address: Texas Instruments, Post Office Box 655303, Dallas, Texas 75265  
Copyright © 2023, Texas Instruments Incorporated