

PRODUCT NUMBER

SEE PART NO. TABLE

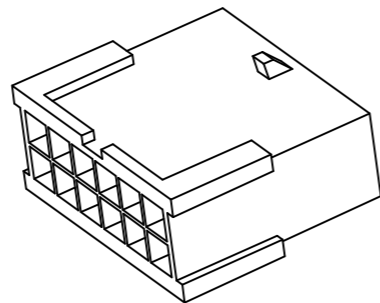
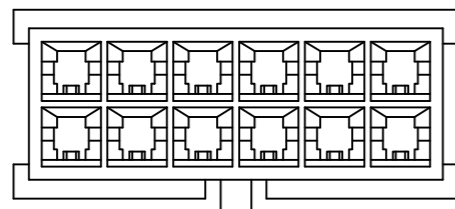
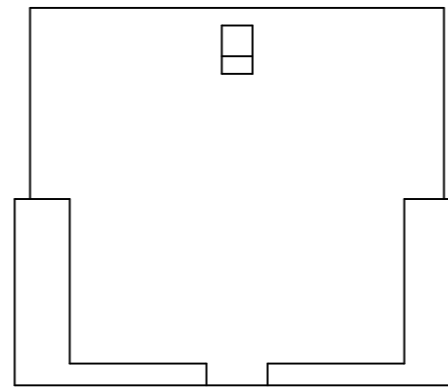
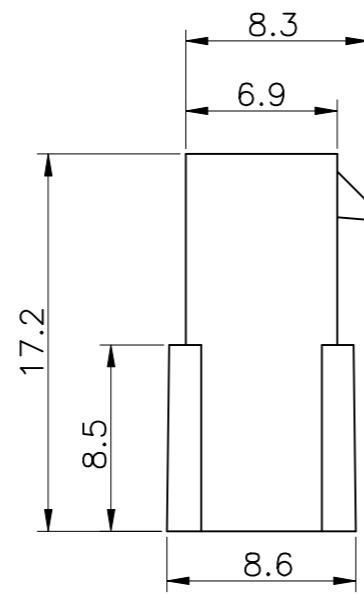
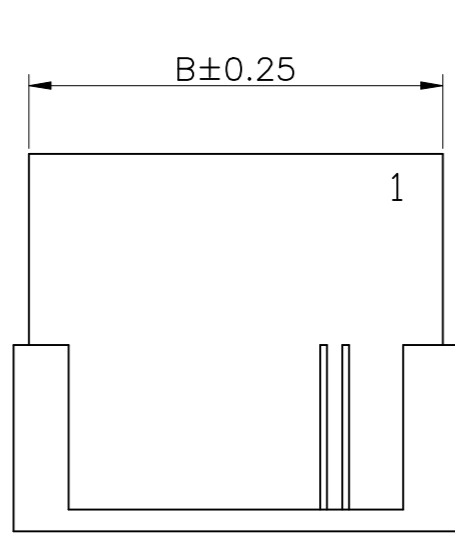
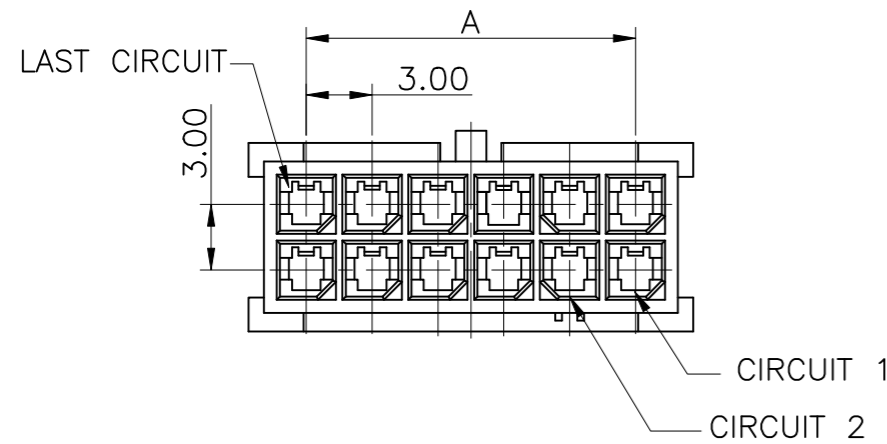

NOTE:

1. MATERIAL:  
HOUSING: HIGH TEMP. NYLON, HALOGEN FREE  
UL94V-0, COLOR: BLACK
2. REFER GS-20-0399 APPLICATION SPECIFICATION FOR MATING CONNECTOR.
3. PRODUCT SPECIFICATION: GS-12-1291.
4. PACKAGE SPECIFICATION: GS-14-2419 (BULK PACKED)
5. APPLICATION SPECIFICATION: GS-20-0399.
6. LEAD FREE PRODUCTS MEET EUROPEAN UNION DIRECTIVES AND OTHER COUNTRY REGULATIONS AS DESCRIBED IN GS-47-0004
7. PART NUMBER SCHEME:  
10132446- XX LF  
POS. CODE: ——— LEAD FREE  
02: 2 POS.  
04: 4 POS.  
    ∩  
24: 24 POS.

DIMENSIONAL & PART NO. TABLE:

PART NO.	POS	A	B
10132446-02LF	2	3.0	3.85
10132446-04LF	4	6.0	6.85
10132446-06LF	6	9.0	9.85
10132446-08LF	8	12.0	12.85
10132446-10LF	10	15.0	15.85
10132446-12LF	12	18.0	18.85
10132446-14LF	14	21.0	21.85
10132446-16LF	16	24.0	24.85
10132446-18LF	18	27.0	27.85
10132446-20LF	20	30.0	30.85
10132446-22LF	22	33.0	33.85
10132446-24LF	24	36.0	36.85

mat'l. code				surface <input checked="" type="checkbox"/> ISO 1302 <input type="checkbox"/> ISO 406 <input type="checkbox"/> ISO 1101		tolerance		projection		product family			
ltr				ecn no		dr		date		tolerances unless otherwise specified		title	
A				TAI		2015-02-03		angles		linear		MINITEK PWR3.0 HCC	
B				ELX-I-43460		AKHIL		2022-01-21		0°±3'		mm	
										scale		N.T.S	
												MINITEK PWR3.0 PLUG. HSG	
												D/R HIGH CURRENT	
												sheet 1 of 2 size	
												10132446 A3	
												type Product Customer Drawing	
sheet index		revision sheet		B 1		B 2							

Amphenol FCI

© 2016 AFCI

©



Amphenol FCI

© 2016 AFCI

2 POS.

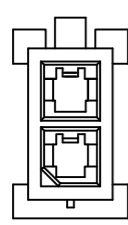

10 POS.

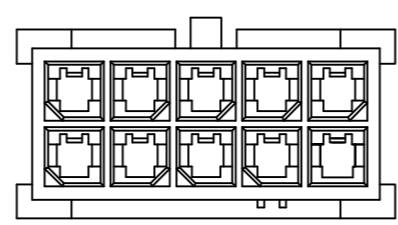

18 POS.

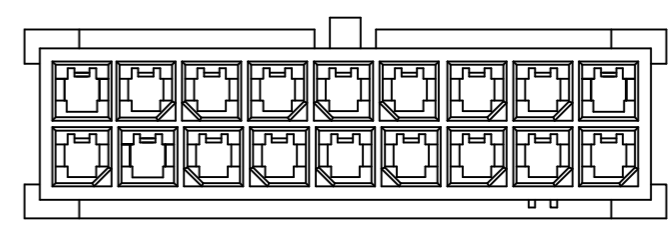

4 POS.

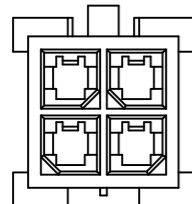

12 POS.

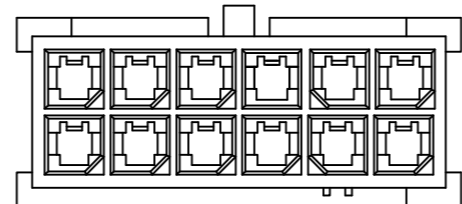

20 POS.

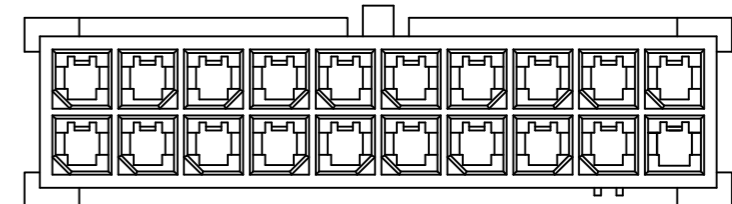

6 POS.

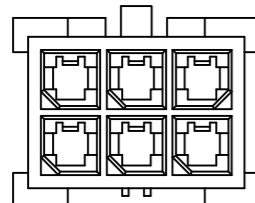

14 POS.

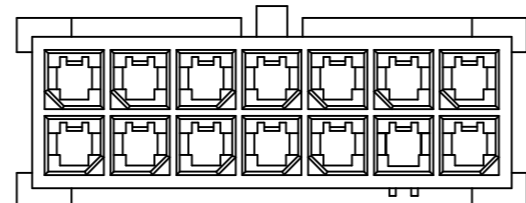

22 POS.

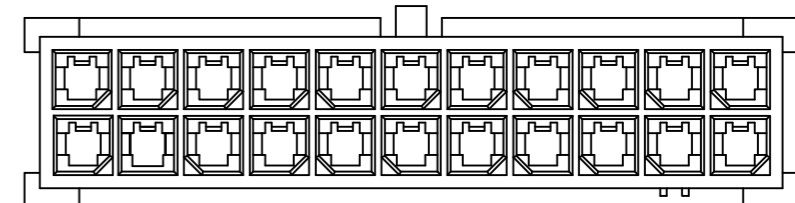

8 POS.

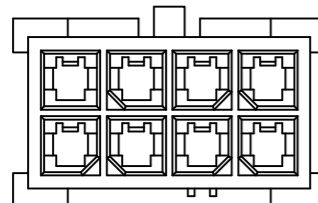

16 POS.

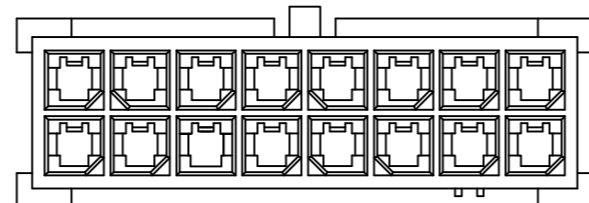

24 POS.

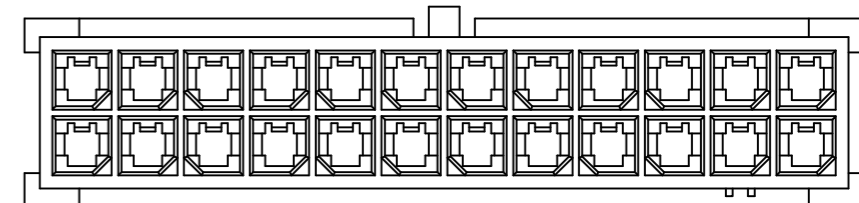

mat'l. code		surface		tolerance		projection		product family	
		ISO 1302		ISO 406 ISO 1101				MINITEK PWR3.0 HCC	
ltr		ecn no		dr		date		title	
								MINITEK PWR3.0 PLUG. HSG	
				angles		linear		D/R HIGH CURRENT	
				0°±3'					
				dr		KENNY TAI 2015-02-03		dwg no	
				engr		AKHIL RAJAN 2022-01-21		sheet 2 of 2	
				chr		MITHUN PAUL 2022-01-21		size	
				appd		SPK 2022-01-21		A3	
sheet		revision		B		B		type	
index		sheet		1		2		Product Customer Drawing	