

APPROVED: _____
 DATE: _____ TITLE: _____

Rev	AWO #	Description	Date	Appr
-		RELEASED	1/26/21	
A		ADDED SPEC.	6/21/21	WX/RC

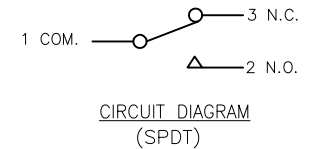
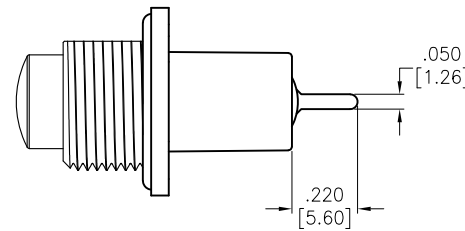
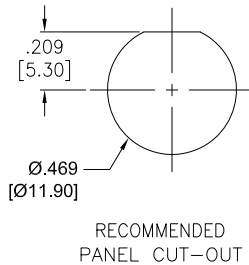
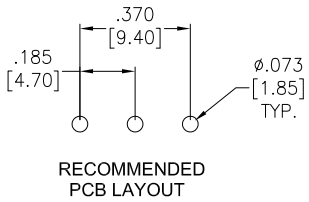
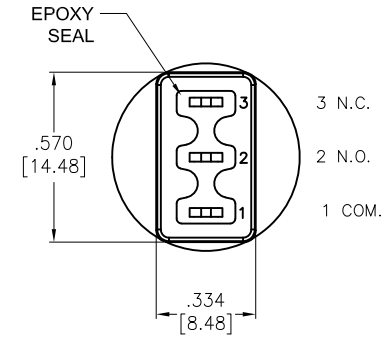
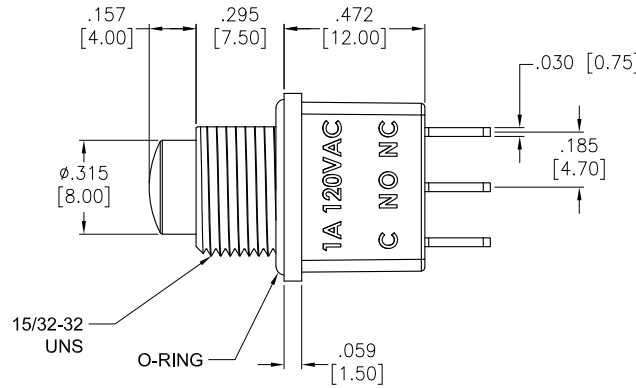
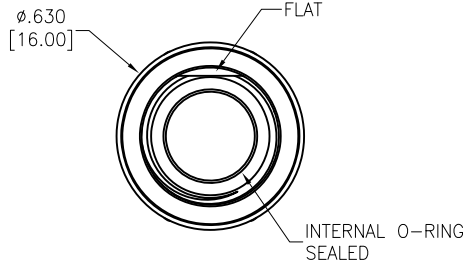

SPECIFICATIONS:

Material:
 Case: DAP, Rated UL94V-0
 Plunger: Brass, color Black w/ O-Ring
 Bushing: Brass, color Black w/ O-Ring
 Movable Contact: Copper Alloy, Silver Plated
 Terminal: Copper Alloy, Silver Plated

Electrical:
 Rating: 1A @ 120VAC or 38V DC
 Contact resistance: 10 mΩ max
 Insulation resistance: 1,000 Mohms min
 Dielectric withstanding voltage: 1,500V RMS @Sea level
 Life: 50,000 cycles at full load
 Temperature Rating:
 Operating temperature: -30°C to +85°C

Environmental:
 Sealed IP68 Rated
 Lead free, RoHS compliant

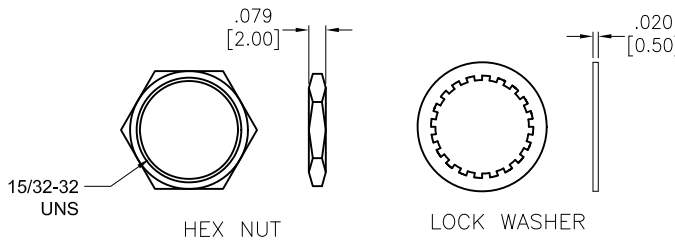

BUTTON POSITION		
FUNCTION	ON	MOM
TERMINALS	1-3	1-2

UNLESS OTHERWISE SPECIFIED
 ALL DIMENSIONS ARE INCHES [MM]
 TOLERANCES: EXCEPT AS NOTED

INCHES		HOLES	
.X	± .10	Ø.X	± .10
.XX	± .020	Ø.XX	± .015
.XXX	± .015	Ø.XXX	± .010



909 Rahway Avenue,
 Union, NJ 07083
 Phone: 908-687-5000
 Fax: 908-687-5710

TITLE
 HIGH PERFORMANCE PUSH BUTTON SWITCH,
 SPDT, ON-MOM, SILVER PLATED, PCB TAILS

APPROVALS		DATE
DRAWN	LH	1/26/21
CHECKED	AC	1/26/21
APPROVED		

SIZE	PART NO.	REV.
X	SW-PB10-CBB2QE-4	A
REF: S00198T	SCALE: NTS	SHEET 1 OF 1