

**Note:** All part numbers are RoHS Compliant.

## Table of Contents—NEMA ETB

|  |         |
|--|---------|
| Overview (Selector Chart) .....                                | 240-243 |
| Catalog Numbering Code .....                                   | 244     |
| Miniature Blocks, 100 Series .....                             | 245-248 |
| Medium Duty, 900 Series/ERT Series (Radiation Resistant) ..... | 249-257 |
| Heavy Duty, 200 Series .....                                   | 259-266 |
| Heavy Duty, Phenolic, 200 Series .....                         | 267-272 |
| Intermediate Heavy Duty, 800 Series .....                      | 273-276 |
| Ultra Heavy Duty, 400 Series .....                             | 277-279 |
| Fuse & Switch .....  | 281-288 |
| One-Piece Phenolic Blocks .....                                | 289-292 |
| Accessories .....  | 293     |
| Technical Summary .....  | 294-295 |
| UL 1059 Basic Voltage Rating .....                             | 296     |





**Note:** All part numbers are RoHS Compliant.

**NEMA ETB Selector Chart**

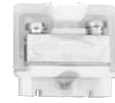
**High Density Series 100**

**Medium Duty Series 900**



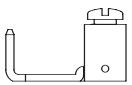







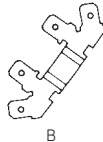
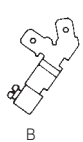

|  | High Density Miniature                     | High Density Single Tier  | High Density Double Tier           | Medium Duty   |   |  |  |
|--|--|---|------------------------------------|---|---|--|--|
| <b>Mounting</b>  | Direct Mount, Miniature Channel            | Direct Mount, Standard & Breakaway Channel  | Channel only: Standard & Breakaway | Direct Mount Standard, Miniature & Breakaway Channels                                   |   |  |  |
| <b>AWG Wire Range</b>  | #30-12                                     | #30-12  | #30-12                             | #22-8   | #22-8   | 10*, #22-14  | #22-10   |
| <b>Contact Types</b>   |  | Tubular Clamp   |                                    | Tubular Clamp   | Tubular Screw   | Strap Screw  | Plug-In  |
| <b>R=</b> Shipped with screws raised<br><b>B=</b> Shipped with screws bottomed |  | <br>B |                                    | <br>B | <br>B | <br>B |  |
| <b>Ampacity</b>  | 28A  | 28A   | 25A                                | 30A   | 50A   | 35A*, 15A  | 30A  |
| <b>Voltage</b>   | 300 V<br>600 V<br>(Limited Power Circuits) | 600 V   | 600 V                              | 600 V   | 600 V   | 600 V  | 600 V  |
| <b>Center-to-Center Spacing</b>  | .25"<br>[6.35]                             | .25"<br>[6.35]  | .24"<br>[6.10]                     | .375"<br>[9.53]   | .375"<br>[9.53]   | .375"<br>[9.53]  | .375"<br>[9.53]  |
| <b>Housing Material</b>  | Nylon or Polypropylene                     | Nylon   | Nylon                              | PCT   | PCT   | PCT  | PCT  |
| <b>Flammability Rating</b>   | UL94V-2 or UL94V-0                         | UL94V-2   | UL94V-2                            | UL94V-0   | UL94V-0   | UL94V-0  | UL94V-0  |
| <b>Max. Service Temperature</b>  | 125°C (257°F) or 105°C (222°F)             | 125°C (257°F)   | 125°C (257°F)                      | 150°C (302°F)   | 150°C (302°F)   | 150°C (302°F)  | 150°C (302°F)  |
| <b>Pages</b>   |  | 246   |                                    | 250   | 250   | 250  | 251  |

\*Acceptable for 35A max. factory wiring only when used with 10AWG wire preterminated with suitable ring tongue terminals.



**Note:** All part numbers are RoHS Compliant.











**NEMA ETB Selector Chart** (Continued)

|  | <b>Medium Duty Series 900</b>  |  | <b>ERT Series</b>   |   |  | <b>Heavy Duty Series 200</b>  |   |   |   |
|--|--|--|---|---|--|---|---|---|---|
|  |   |  |    |   |  |                        |   |   |   |
|  | <b>Medium Duty</b>   |  | <b>Medium Duty Radiation Resistant</b>  |   |  | <b>Nylon or Polypropylene</b>   |   |   |   |
| <b>Mounting</b>  | Direct Mount Standard, Miniature & Breakaway Channels                              |  | Standard and Breakaway Channels   |   |  | Direct Mount or:<br>Flat Base fits Miniature Channel.<br>Dovetail Base fits Standard & Breakaway Channels |   |   |   |
| <b>AWG Wire Range</b>  | —  | #18-12   | #22-8   | #22-8   | #10*, #22-14   | #18-6 smaller   | #18-4   | #18-8   | #10 & smaller   |
| <b>Contact Types</b>   | Quick Connect  | Tubular Quick Connect Combination  | Tubular Clamp   | Tubular Screw   | Strap Screw  | Tubular Clamp   | Tubular Screw   | Strap Clamp   | Strap Screw   |
| <b>R</b> =Shipped with screws raised<br><b>B</b> =Shipped with screws bottomed |  |  |  |  |  |                      |  |  |  |
| <b>Ampacity</b>  | 20A  | 20A  | 30A   | 50A   | 35A*, 15A  | 65A   | 85A   | 50A   | 35A   |
| <b>Voltage</b>   | 300 V  |  | 600 V   |   |  | 600 V   |   |   |   |
| <b>Center-to-Center Spacing</b>  | .375"<br>[9.53]  |  | .375"<br>[9.53]   |   |  | .50"<br>[12.70]   |   |   |   |
| <b>Housing Material</b>  | PCT  |  | RYTON   |   |  | Nylon or Polypropylene  |   |   |   |
| <b>Flammability Rating</b>   | UL94V-0  |  | UL94V-0   |   |  | UL94V-2 or UL94V-0  |   |   |   |
| <b>Max. Service Temperature</b>  | 150°C (302°F)  |  | 200°C (392°F)   |   |  | 125°C (257°F) or 105°C (222°F)  |   |   |   |
| <b>Pages</b>   | 250  | 251  | 252   |   |  | 260-261   |   |   |   |



**Note:** All part numbers are RoHS Compliant.

**NEMA ETB Selector Chart** (Continued)

|  | Heavy Duty Series 200  |  |  |  | Intermediate HD Series 800   |  | Ultra Heavy Duty Series 400  |  |
|--|--|--|--|--|--|--|--|--|
|  |         |  |  |  |        |  |         |  |
|  | <b>Phenolic</b>  |  |  |  | <b>Intermediate Heavy Duty</b>   |  | <b>Ultra Heavy Duty</b>  |  |
| <b>Mounting</b>  | Direct Mount or Standard & Breakaway Channels  |  |  |  | Direct Mount or Standard & Breakaway Channels  |  | Direct Mount or Standard & Breakaway Channels  |  |
| <b>AWG Wire Range</b>  | #18-6  | #18-4  | #18-8  | #10 & smaller  | #12-1/0  |  | #12-2/0 kcmil (MCM)  |  |
| <b>Contact Types</b>   | Tubular Clamp  | Tubular Screw  | Strap Clamp  | Strap Screw  | Tubular Screw  |  | Tubular Screw  | Tubular Screw  |
| <b>R</b> =Shipped with screws raised<br><b>B</b> =Shipped with screws bottomed | <br>B | <br>R | <br>B | <br>B | <br>B |  | <br>R | <br>R |
| <b>Ampacity</b>  | 65A  | 85A  | 50A  | 35A  | 150A   |  | 175A   | 255A   |
| <b>Voltage</b>   | 600 V  |  |  |  | 600 V  |  | 600 V  |  |
| <b>Center-to-Center Spacing</b>  | .56"<br>[14.22]  |  |  |  | .75"<br>[19.05]  |  | 1.19"<br>[30.23]   |  |
| <b>Housing Material</b>  | Phenolic   |  |  |  | Nylon  |  | Phenolic   |  |
| <b>Flammability Rating</b>   | UL94V-1  |  |  |  | UL94V-2  |  | UL94V-1  |  |
| <b>Max. Service Temperature</b>  | 150°C (302°F)  |  |  |  | 125°C (257°F)  |  | 150°C (302°F)  |  |
| <b>Pages</b>   | 267-272  |  |  |  | 273-276  |  | 277-279  |  |







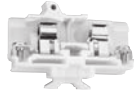

**Note:** All part numbers are RoHS Compliant.

**NEMA ETB Selector Chart** (Continued)

**Fuse and Switch Series 300**

**One-Piece**



|  | Nylon or Polypropylene   |  |  | Phenolic   |  |   | One-Piece  |  |  |
|--|--|--|--|--|--|---|--|--|--|
| <b>Mounting</b>  | Direct Mount or Standard & Breakaway Channels  |  |  | Direct Mount or Standard & Breakaway Channels  |  |   | Direct Mount   |  |  |
| <b>AWG Wire Range</b>  | #18-8  | #18-8  | #8   | #18-8 & Smaller  | #18-8  | #8 & Smaller  | #6   | #8   | #8   |
| <b>Contact Types</b>   | Tubular Screw  | Strap Clamp  | Strap Screw  | Tubular Screw  | Strap Clamp  | Strap Screw   | Tubular Clamp  | Strap Clamp  | Strap Screw  |
| <b>R</b> =Shipped with screws raised<br><b>B</b> =Shipped with screws bottomed | <br>B | <br>B | <br>B | <br>B | <br>B | <br>B | <br>B | <br>B | <br>B |
| <b>Ampacity</b>  | 15A Switch<br>30A Fuse   |  |  | 15A Switch<br>30A Fuse   |  |   | 70A  | 50A  | 50A  |
| <b>Voltage</b>   | 600 V  |  |  | 600 V  |  |   | 600 V  |  |  |
| <b>Center-to-Center Spacing</b>  | .75"<br>[19.05]  |  |  | .75"<br>[19.05]  |  |   | .63"<br>[16.00]  |  |  |
| <b>Housing Material</b>  | Nylon or Polypropylene   |  |  | Phenolic   |  |   | Phenolic   |  |  |
| <b>Flammability Rating</b>   | UL94V-2 or UL94V-0   |  |  | UL94V-1  |  |   | UL94V-1  |  |  |
| <b>Max. Service Temperature</b>  | 125°C (257°F) or 105°C (222°F)   |  |  | 150°C (302°F)  |  |   | 150°C (302°F)  |  |  |
| <b>Pages</b>   | 282-285  |  |  | 286-288  |  |   | 289-292  |  |  |

**Note:** All part numbers are RoHS Compliant.

**Catalog Numbering Code**

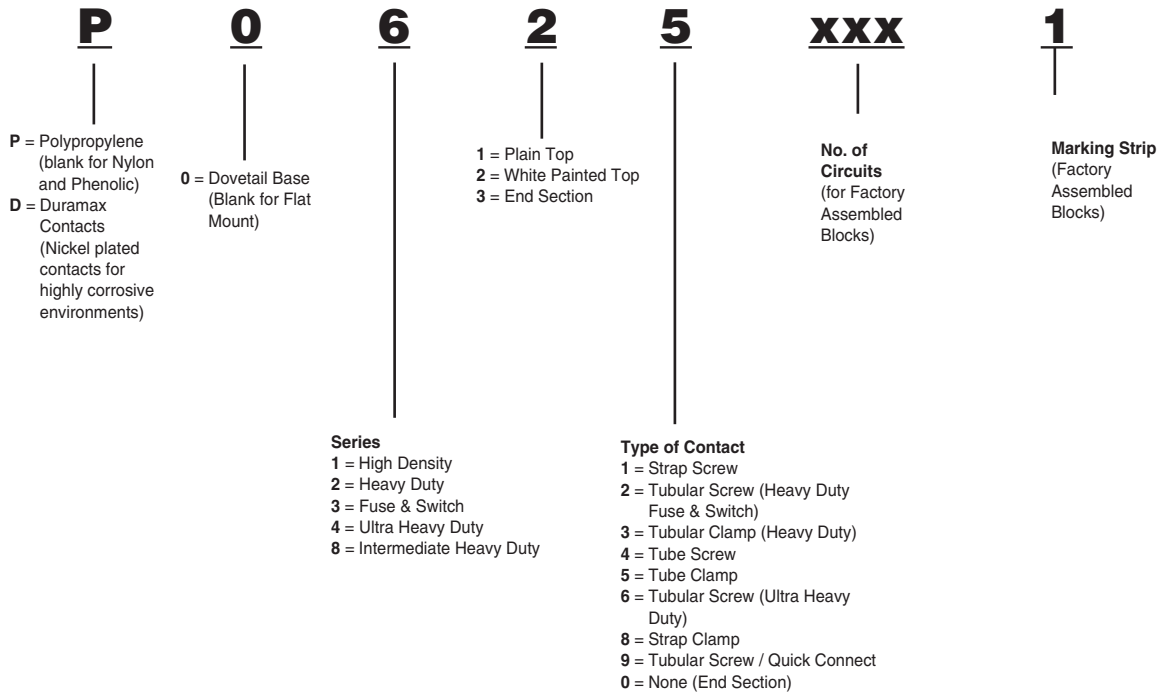

**Note:** Some catalog number combinations are not valid. Check appropriate catalog pages before ordering.

## 100 Series High Density Miniature Blocks

### Product Facts

- n **No Wire Crimping Required** — tubular clamp contacts hold wire ranging from #30 to #12 AWG better than crimp-on terminals.
- n **Saves Installation Time and Costs** — tubular clamp contacts are supplied with captive screws backed out.
- n **Nylon housing standard; polypropylene for fire retardant characteristics.**
- n **Positive Stop** — helps prevent wire from being inserted too far, and helps prevent screw from being tightened on insulation. Easy access contact provides for safe, reliable, and cost-effective connection.
- n **Quick Installation and Change** — additional sections may be added or removed without removing channel mounting screw.
- n **Choice of Five Mounting Channels:**
  - n **Miniature aluminum**
  - n **Zinc-plated steel**
  - n **Pre-punched aluminum**
  - n **Break-away steel**
- n **Single and Double Tier blocks fit all standard BUCHANAN mounting channels. Single Tier blocks fit both miniature and standard channels.**
- n **Choice of Marking Surfaces** — matte-finish area for marking directly on block; slide-in vinyl strip (blank or preprinted) also available.

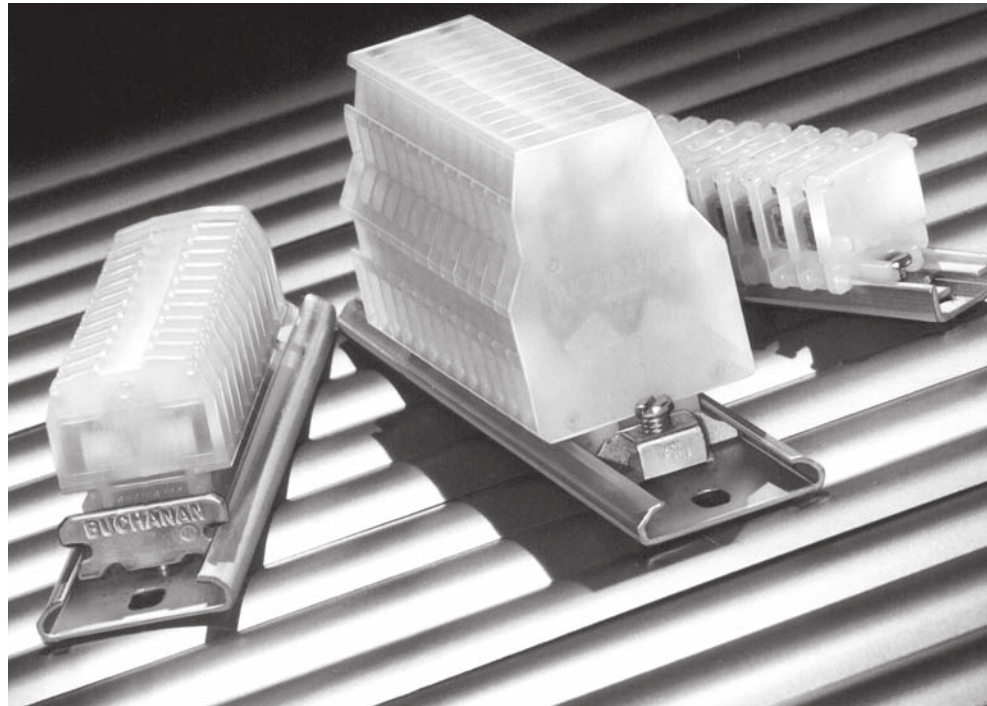

These miniature terminal blocks fit on a much smaller channel to save valuable panel space or can be surface mounted directly to the panel. Miniature blocks accept wire as large as #12 AWG and are available in four styles: Miniature (nylon), Miniature (polypropylene), Single Tier and Double Tier.

## 100 Series High Density Miniature Blocks

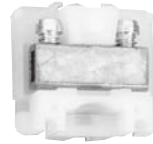

**Miniature Nylon**



**Miniature Polypropylene**



**Single Tier**

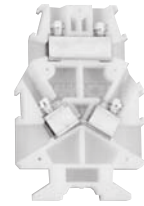

**Double Tier**

**Characteristics**

| Type of Block                                | Model         | Part Number | Model         | Part Number | Model         | Part Number | Model         | Part Number |
|--|---------------|-------------|---------------|-------------|---------------|-------------|---------------|-------------|
| Standard Block                               | 125-BU        | 2-1437392-3 | P125          | 4-1437392-7 | 115-BU        | 1437381-5   | 105-BU        | 1-1437392-7 |
| Corrosion Resistant (nickel plated contacts) | D125          | 3-1437389-3 | DP125         | 7-1437389-1 | D115          | 3-1437389-2 | D105          | 2-1437392-9 |
| <b>Specifications</b>                        |               |             |               |             |               |             |               |             |
| Housing Material                             | Nylon         | —           | Polypropylene | —           | Nylon         | —           | Nylon         | —           |
| Max. Service Temperature                     | 125°C (257°F) | —           | 105°C (221°F) | —           | 125°C (257°F) | —           | 125°C (257°F) | —           |
| Flammability                                 | UL94V-2       | —           | UL94V-0       | —           | UL94V-2       | —           | UL94V-2       | —           |
| Wire Strip Length (in.)                      | 5/16          | —           | 5/16          | —           | 5/16          | —           | 5/16          | —           |
| Torque, in-lbs.                              | 6-9           | —           | 6-9           | —           | 6-9           | —           | 6-9           | —           |
| <b>Electrical Characteristics</b>            |               |             |               |             |               |             |               |             |
| UL Rating                                    | 20 A @ 300V   | —           | 20 A @ 300V   | —           | 20 A @ 600V   | —           | 20 A @ 600V   | —           |
| Wire Range (solid & stranded)                | 30-12         | —           | 30-12         | —           | 30-12         | —           | 30-12         | —           |
| <b>Spacing</b>                               |               |             |               |             |               |             |               |             |
| Pitch  | 0.25"         | —           | 0.25"         | —           | 0.25"         | —           | 0.24"         | —           |
| Terminals per Foot                           | 48            | —           | 48            | —           | 48            | —           | 102           | —           |
| <b>Accessories</b>                           |               |             |               |             |               |             |               |             |
| End Section (gray)                           | 130-BU        | 2-1437392-5 | P130          | 4-1437392-9 | 120           | 2-1437392-1 | 110-BU        | 1-1437392-8 |
| Jumper, 2 pole                               | 10            | 1437381-1   | 10            | 1437381-1   | 10            | 1437381-1   | —             | —           |
| Jumper, 10 pole                              | —             | —           | —             | —           | —             | —           | J10           | 3-1437392-1 |
| Jumper, Inter-tier                           | —             | —           | —             | —           | —             | —           | J2-BU         | 3-1437392-2 |
| <b>Mounting Channel</b>                      |               |             |               |             |               |             |               |             |
| Miniature (3ft)                              | 12            | 1437381-8   | 12            | 1437381-8   | 12            | 1437381-8   | —             | —           |
| Steel, Zinc plated (6ft)                     | —             | —           | —             | —           | 60            | 9-1437381-1 | 60            | 9-1437381-1 |
| Steel, Zinc plated (3ft)                     | —             | —           | —             | —           | 63-BU         | 9-1437381-8 | 63-BU         | 9-1437381-8 |
| Breakaway, steel                             | —             | —           | —             | —           | 60B36         | 9-1437381-2 | 60B36         | 9-1437381-2 |
| Pre-punched aluminum (6ft)                   | —             | —           | —             | —           | 64            | 9-1437381-9 | 64            | 9-1437381-9 |
| Pre-punched aluminum (3ft)                   | —             | —           | —             | —           | 67            | 1437382-2   | 67            | 1437382-2   |
| <b>Channel Clamps</b>                        |               |             |               |             |               |             |               |             |
| Miniature (use w/#12 channel)                | 11            | 1437381-4   | 11            | 1437381-4   | 11            | 1437381-4   | —             | —           |
| Universal                                    | —             | —           | —             | —           | 68            | 1437382-3   | 68            | 1437382-3   |



**100 Series High Density Miniature Blocks Accessories**

**Channel Clamps**

**Marking Accessories**



| Screw Steel Channel        | Universal                  | Snap-in                    | Miniature for #12 Channel | See-thru Cover           | Ganging Rod              | Miniature Vinyl Marking Strips          | Elevated Marking Strip                  | Nylon Holding Plug       |
|----------------------------|----------------------------|----------------------------|---------------------------|--------------------------|--------------------------|---|---|--------------------------|
| <b>Part Number</b>         |                            |                            |                           |                          |                          |   |   |                          |
| 9-1437381-5                | 1437382-3                  | 9-1437381-7                | 1437381-4                 | 1-1437381-0              | 1-1437381-1              | 1-1437381-2                             | 4-1437381-1                             | 1-1437381-3              |
| <b>Catalog Number</b>      |                            |                            |                           |                          |                          |   |   |                          |
| 61                         | 68                         | 62                         | 11                        | 13                       | 14                       | 15                                      | 52-BU                                   | 16                       |
| <b>Available For</b>       |                            |                            |                           |                          |                          |   |   |                          |
| Single Tier<br>Double Tier | Single Tier<br>Double Tier | Single Tier<br>Double Tier | Miniature<br>Single Tier  | Miniature<br>Single Tier | Miniature<br>Single Tier | Miniature<br>Single Tier<br>Double Tier | Miniature<br>Single Tier<br>Double Tier | Miniature<br>Single Tier |
| <b>Standard Length</b>     |                            |                            |                           |                          |                          |   |   |                          |
| —                          | —                          | —                          | —                         | —                        | 2 feet                   | 25 feet                                 | 18 inches                               | —                        |

**Factory Assembled Blocks**

| Description               | Direct Mount     | Channel Mount     |
|---------------------------|------------------|-------------------|
| Miniature (nylon)         | 125xx            | 0125xx            |
|                           | D125xx (nickel)  | D0125xx (nickel)  |
| Single Tier (nylon)       | 115xx            | 0115xx            |
|                           | D115xx (nickel)  | D0115xx (nickel)  |
| Double Tier (nylon)       | 105xx            | 0105xx            |
|                           | D105xx (nickel)  | D0105xx (nickel)  |
| Miniature (polypropylene) | P125xx           | P0125xx           |
|                           | DP125xx (nickel) | DP0125xx (nickel) |

**Note:** xx = number of blocks desired. For factory assembled blocks with removable marking strip, add "-1" to Catalog Number. Minimum order quantities may apply.

**Related Product Data**

**Wire Pins and Ferrules**—Pages 109-111

For more information on AMP Standard Terminals and Splices or Quick-Connect FASTON Receptacles and Tabs, request Catalog 82042.



**Note:** All part numbers are RoHS Compliant.

**Miniature Blocks**

**Miniature**

$C = .29 [7.37] + (.25 [6.35] \times N)$   
 $L = .51 [12.95] + (.25 [6.35] \times N)$

**On Miniature Channel:**

$C_{CH} = 1.00 [25.4] + (.25 [6.35] \times A)$   
 $L_{CH} = 1.35 [34.29] + (.25 [6.35] \times A)$   
 A = N when N is even  
 A = N + 1 when N is Odd  
 N = No. of Miniature Sections

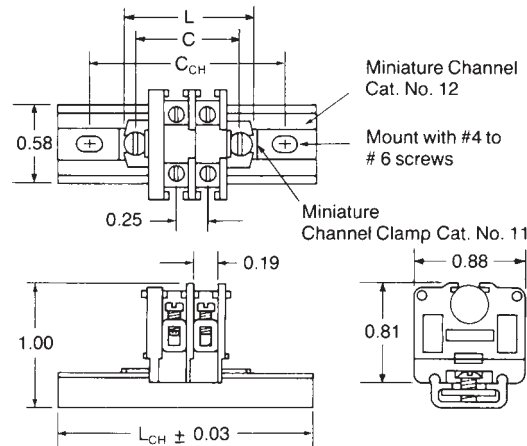

**Single Tier**

$C = .35 [8.89] + (.25 [6.35] \times N)$   
 $L = .50 [12.7] + (.25 [6.35] \times N)$

**On Standard Channel:**

$C_{CH} = 2.00 [50.8] + (.25 [6.35] \times N)$   
 $L_{CH} = 2.75 [69.85] + (.25 [6.35] \times N)$   
 N = No. of Single Tier Sections

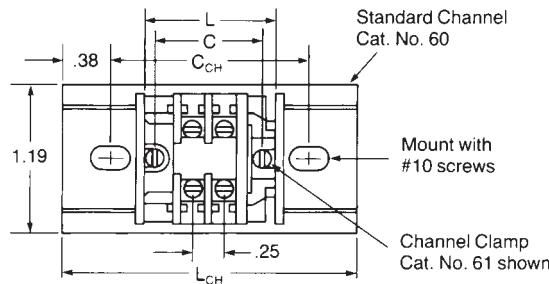

**On Miniature Channel:**

$C_{CH} = 1.00 [25.4] + (.25 [6.35] \times A)$   
 $L_{CH} = 1.35 [34.29] + (.25 [6.35] \times A)$   
 A = N when N is Even  
 A = N + 1 when N is Odd  
 N = No. of Single Tier Sections

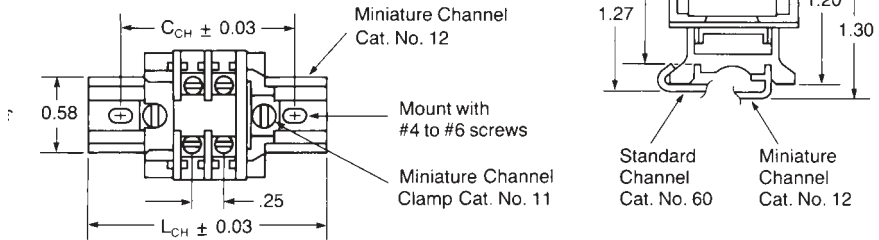

**Double Tier**

$L = .08 [2.03] + (.24 [6.10] \times N)$

**On Miniature Channel:**

$C_{CH} = 1.58 [2.03] + (.24 [6.10] \times A)$   
 $L_{CH} = 2.33 [59.18] + (.24 [6.10] \times A)$   
 N = No. of Double Tier Sections

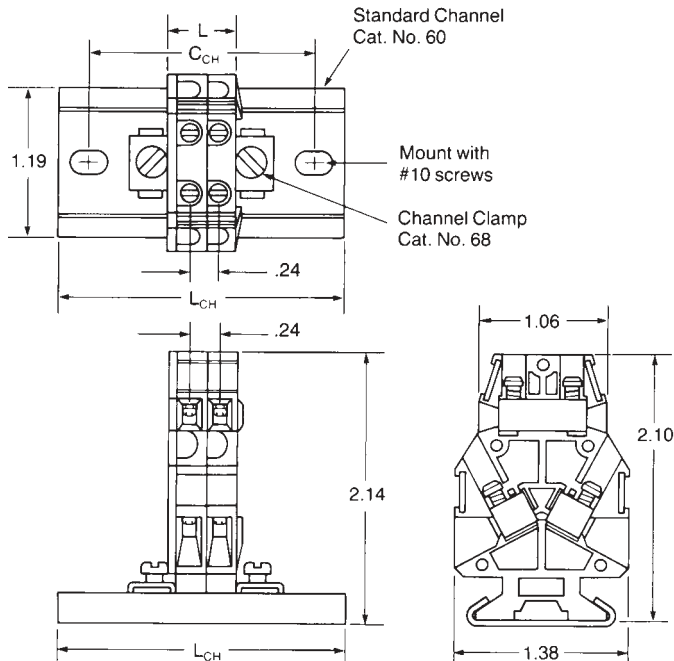

## 900 Series, Medium Duty

### Product Facts

- n High circuit density - 183 circuits per 6-foot length, 3/8 inch pitch.
- n Choice of five contact styles - tubular clamp, tubular screw, strap screw, quick connect and tubular screw quick connect.
- n Sections snap-fit with Heavy Duty, Intermediate Heavy Duty, and Fuse & Switch blocks.
- n Readily identify circuits - mark directly on block sections or use removable marking strip. Preprinted marking strips also available.
- n Rated up to 50 amperes per circuit.
- n Flat base models mount directly to surfaces or on miniature channel. Dovetail base mounts on standard size channel.
- n Packaged for rapid handling and assembly - 100 per carton.
- n Only one end section needed per block assembly.
- n Fanning strips - interlocking sectional fanning strips allow entire circuit groups to be connected and disconnected as a single unit.
- n Factory assembled blocks available, including marking strips and different contact sections.

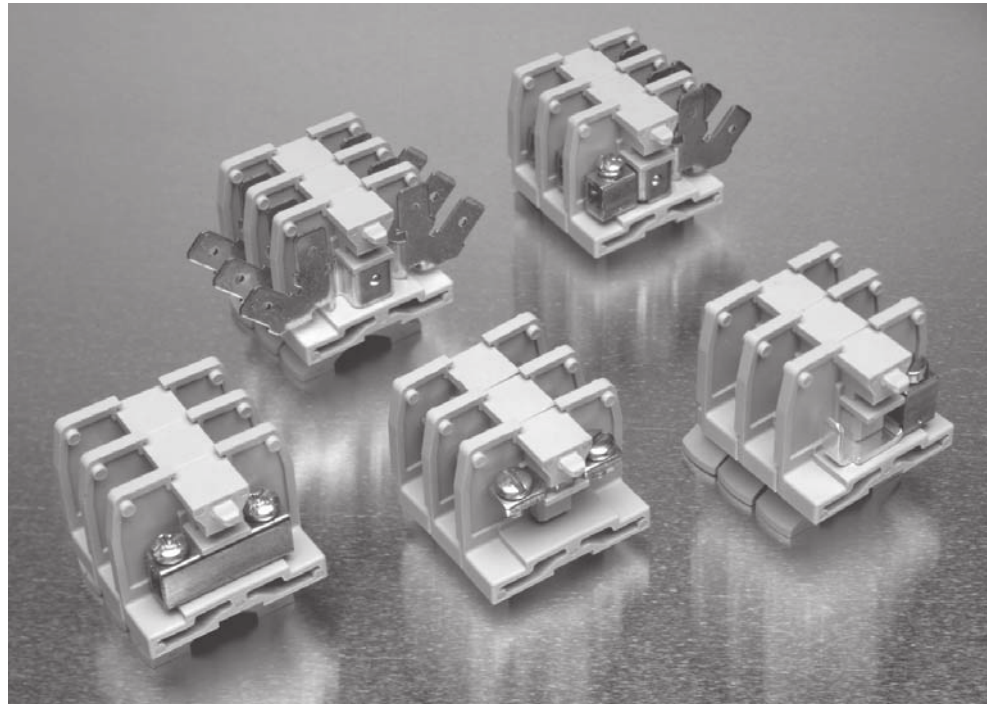

NEMA 900 Series is available in .375" [9.53] centerline, in direct or channel mount, tubular or strap versions, and screw, clamp or quick connect configurations. Corrosion-resistant versions are also available.

NEMA 900 Series snap fit with the Medium Duty 500, 600 and 700 Series, as well as with the Heavy Duty, Intermediate Heavy Duty and Fuse & Switch blocks.

**Note:** All part numbers are RoHS Compliant.

**900 Series, 600V Medium Duty, 0.375" [9.53] Pitch**

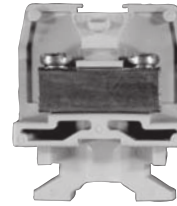
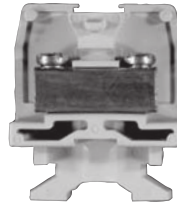
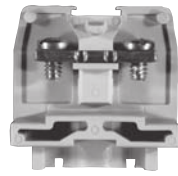

**Characteristics**

**Strap Screw**

**Tubular Screw**

**Tubular Clamp**

**Quick Connect**

| Type of Block                        | Model | Part Number | Model | Part Number | Model | Part Number | Model | Part Number |
|--------------------------------------|-------|-------------|-------|-------------|-------|-------------|-------|-------------|
| <b>Direct Mount (Flat Base)</b>      |       |             |       |             |       |             |       |             |
| Standard                             | 921   | 1546143-1   | 924   | 1546147-1   | 925   | 1546234-1   | 927   | 1546149-1   |
| Corrosion Resistant (Duramax)        | D921  | 1546143-2   | D924  | 1546147-2   | D925  | 1546234-2   | —     | —           |
| <b>Channel Mount (Dovetail Base)</b> |       |             |       |             |       |             |       |             |
| Standard                             | 0921  | 1546144-1   | 0924  | 1546148-1   | 0925  | 1546235-1   | 0927  | 1546150-1   |
| (Duramax)                            | D0921 | 1546144-2   | D0924 | 1546148-2   | D0925 | 1546235-2   | —     | —           |

**Contact Type**

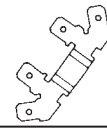

**Specifications**

|                                   |                   |                |                        |      |
|-----------------------------------|-------------------|----------------|------------------------|------|
| Wire Range (AWG) Solid & Stranded | 10*, 22-14        | 22-8           | 22-8                   | —    |
| Wire Strip Length (in.)           | —                 | 11/32          | 11/32                  | —    |
| Screw Type                        | 6-32 Binding Head | 10-32 Pan Head | 10-32 Slotted Pan Head | —    |
| Ampacity                          | 35 A*, 15A        | 50 A           | 30 A                   | 20 A |

**End Sections**

|               |      |           |      |           |      |           |      |           |
|---------------|------|-----------|------|-----------|------|-----------|------|-----------|
| Direct Mount  | 930  | 1546163-1 | 930  | 1546163-1 | 930  | 1546163-1 | 930  | 1546163-1 |
| Channel Mount | 0930 | 1546164-1 | 0930 | 1546164-1 | 0930 | 1546164-1 | 0930 | 1546164-1 |

\*Acceptable for 35A max. factory wiring only when used with 10AWG wire preterminated with suitable ring tongue terminals.  
**Note:** Standard package is 100 pieces for contact, 25 pieces for end section.

**Comparison (Type of Block)**

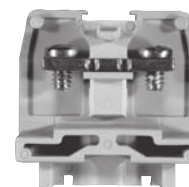

**Direct Mount (Flat Base)**



**Channel Mount (Dovetail Base)**



**Note:** All part numbers are RoHS Compliant.

**900 Series, 600V Medium Duty, 0.375" [9.53] Pitch** (Continued)

**Independent Testing Service Listing and Recognition**

WIRE SIZES, Solid or Stranded  
 Tubular Screw  
 1 #18 AWG to 1 #8 AWG,  
 2 or 3 #12 AWG, 2 to 4 #14 AWG,  
 2 or 4 #16 AWG, 2 to 5 #18 AWG,  
 Tubular Clamp  
 1 #22 AWG to 1 #10 AWG,  
 2 #12 AWG, 2 or 3 #14 AWG,  
 2 to 4 #16 AWG, 2 to 5 #18 AWG,  
 2 to 8 #20 AWG, 2 to 10 #22 AWG,  
 Strap Clamp  
 1 #22 AWG to 1 #10 AWG

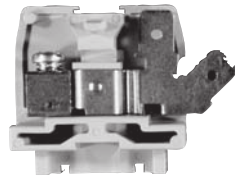

**Tubular Screw & Quick Connect**

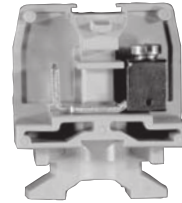

**Tubular Clamp with Blade**

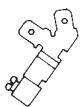
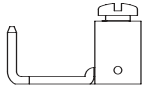

**Tubular Clamp with Cantilever**

| Model   | Part Number | Model  | Part Number | Model              | Part Number |
|---|-------------|--|-------------|--------------------|-------------|
| 929   | 1546151-1   | —  | —           | —                  | —           |
| —   | —           | —  | —           | —                  | —           |
| 0929  | 1546152-1   | BP035M   | 3-1437394-6 | BP35F              | 3-1437394-7 |
| —   | —           | —  | —           | —                  | —           |
|  |             |  |             |                    |             |
| 18-12   |             | 22-10  |             | 22-10              |             |
| —   |             | 11/32  |             | 11/32              |             |
| —   |             | 10-32<br>Phil-slot   |             | 10-32<br>Phil-slot |             |
| 20 A  |             | 30 A   |             | 30 A               |             |
| 930   | 1546163-1   | —  | —           | —                  | —           |
| 0930  | 1546164-1   | 0930   | 1546164-1   | —                  | —           |



**Note:** All part numbers are RoHS Compliant.

**ERT Series, Medium Duty Radiation Resistant**

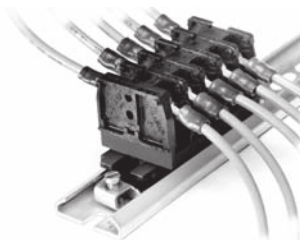

**Physical Properties**  
**Effect of Radiation on Physical Properties**

The effects of radiation (neutron and gamma particles) on RYTON R-4 material have been studied. Since RYTON, as an engineering plastic, may fill applications in nuclear installations these effects are important. The test results show no effects on physical properties by these relatively high exposures to gamma and neutron radiation. There is no indication from these data of crosslinking or degradation of the RYTON R-4 material.

**Note:** Determination of the suitability of the ERT Series Blocks for particular applications rests solely with customers.

DOVETAIL BASE MOUNTED ON STANDARD #60 CHANNEL

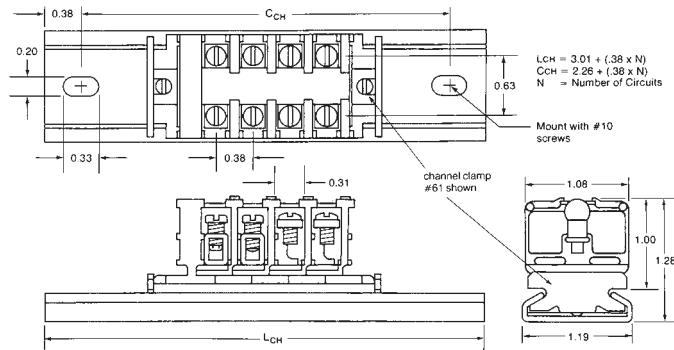

| Description   | Catalog Number | Part Number |
|---------------|----------------|-------------|
| Strap Screw   | 0721ERT        | 1437394-9   |
| Tubular Clamp | 0725ERT        | 1-1437394-6 |
| Tubular Screw | 0724ERT        | 1-1437394-1 |
| End Section   | 0730ERT        | 2-1437394-0 |

| Housing: RYTON (Polyphenylene Sulfide) |                                      | ASTM Test                  |
|--|--------------------------------------|----------------------------|
| Density                                | 100 lbs./ft.3                        | D1505-68                   |
| Tensile Strength                       | 19,500 psi                           | D638-72                    |
| Elongation                             | 1.3%                                 | D638-72                    |
| Flexural Modulus                       | 1,700,000 psi                        | D790-91                    |
| Flexural Strength                      | 29,000 psi                           | D790-91                    |
| Compressive Strength                   | 21,000 psi                           | D695-69                    |
| Izod Impact Strength                   |                                      |                            |
| Unnotched, 1/8" Specimen               | 8.0 ft. lbs./in.                     |                            |
| Notched, 1/8" Specimen                 | 1.4 ft. lbs./in.                     |                            |
| Rockwell Hardness                      | R-123                                | D785-65                    |
| Water Absorption                       | 0.05%                                | D570-63                    |
| Heat Distortion Temp. @ 264 psi        | 500°F                                | D648-72                    |
| Specific Heat, 24 hrs. @ 25°C          | 0.25 btu/lb./°F                      |                            |
| Thermal Conductivity                   | 2.0 btu-in./h-ft.2 F                 |                            |
| Coefficient/Linear Thermal Exp.        | 2.5 x 10-5 in./in./°F                |                            |
| Flammability, UL 94                    | V-0                                  |                            |
| Dielectric Strength                    | 350 volts/mil                        | D149-64                    |
| Dielectric Constant, 25°C 1 kHz        | 3.9                                  | D150-70                    |
| 1MHz                                   | 3.8                                  |                            |
| Dissipation Factor, 25°C 1kHz          | 0.0010                               | D150-70                    |
| 1MHz                                   | 0.0013                               |                            |
| <b>Conditions</b>                      |                                      |                            |
| Temperature                            | In Reactor Core 35°C                 | In Water Pool 30°C         |
| Radiation                              | Mainly neutrons                      | Mainly gamma               |
| Intensity                              | 1010 ergs g-1 (C)                    | 109 ergs g-1 (C)           |
| Used Particle Detectors                | Calorimeter and activation detectors | Ionization chamber         |
| <b>Radiation Dose</b>                  |                                      |                            |
|  | Flexural Strength psi                | Modulus of Elasticity, psi |
| 0                                      | 28,700                               | 1,900,000                  |
| <b>A. Neutron</b>                      |                                      |                            |
| 5 x 10 rad                             | 29,000                               | 1,910,000                  |
| 1 x 10 rad                             | 28,900                               | 1,880,000                  |
| <b>B. Gamma</b>                        |                                      |                            |
| 5 x 10 rad                             | 29,700                               | 1,810,000                  |
| 1 x 10 rad                             | 30,200                               | 1,840,000                  |
| 5 x 10 rad                             | 28,500                               | 1,820,000                  |

RYTON is a registered trademark of Chevron Phillips Chemical Company.



## Medium Duty Accessories

### Mounting Channel

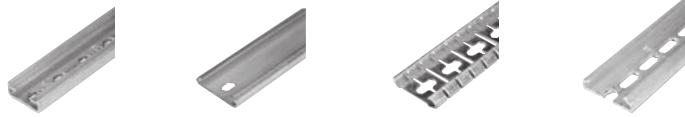

| Miniature              |                | Steel Channel              |                | Break Away Steel |                | Pre-punched Aluminum Channel |                |
|------------------------|----------------|----------------------------|----------------|------------------|----------------|------------------------------|----------------|
| Part Number            | Catalog Number | Part Number                | Catalog Number | Part Number      | Catalog Number | Part Number                  | Catalog Number |
| 1437381-8              | 12             | 9-1437381-1<br>9-1437381-8 | 60<br>63-BU    | 9-1437381-2      | 60-B-36        | 9-1437381-9<br>1437382-2     | 64<br>67       |
| <b>Standard Length</b> |                |                            |                |                  |                |                              |                |
| 3 feet                 |                | 6 feet<br>3 feet           |                | 3 feet           |                | 6 feet<br>3 feet             |                |

### Channel Clamps



| Screw Channel Clamps   | Universal Clamps      | Snap-In Clamps        | Miniature for #12 Channel | See-thru Cover        | Ganging Rod           | Polarizing Plug       |   |
|------------------------|-----------------------|-----------------------|---------------------------|-----------------------|-----------------------|-----------------------|---|
| <b>Part Number</b>     | <b>Part Number</b>    | <b>Part Number</b>    | <b>Part Number</b>        | <b>Part Number</b>    | <b>Part Number</b>    | <b>Part Number</b>    |   |
| 9-1437381-5            | 1437382-3             | 9-1437381-7           | 1437381-4                 | 1-1437382-2           | 3-1437381-9           | 2-1437382-5           |   |
| <b>Catalog Number</b>  | <b>Catalog Number</b> | <b>Catalog Number</b> | <b>Catalog Number</b>     | <b>Catalog Number</b> | <b>Catalog Number</b> | <b>Catalog Number</b> |   |
| 61                     | 68                    | 62                    | 11                        | 71                    | 30-BU                 | 84                    |   |
| <b>Standard Length</b> |                       |                       |                           |                       |                       | 2 feet                | — |

### Jumpers



| Jumper for tubular Contacts | Snap-apart for Tubular Contacts |
|-----------------------------|---------------------------------|
| <b>Part Number</b>          | <b>Part Number</b>              |
| 1437382-6                   | 1-1437382-3                     |
| <b>Catalog Number</b>       | <b>Catalog Number</b>           |
| 70                          | 73                              |

### Related Product Data

**Wire Pins and Ferrules**—Pages 109-111  
For more information on AMP Standard Terminals and Splices or Quick-Connect FASTON Receptacles and Tabs, request Catalog 82042.

**Note:** All part numbers are RoHS Compliant.

## Medium Duty Accessories (Continued)

### Marking Accessories



| Plastic Cloth Tape     | Plastic Cloth Tape | Vinyl Marking Strips | Elevated Marking Strip | Nylon Holding Plug |
|------------------------|--------------------|----------------------|------------------------|--------------------|
| <b>Part Number</b>     |                    |                      |                        |                    |
| 1437382-1              | 8-1437381-0        | 6-1437381-3          | 4-1437391-1            | 4-1437393-0        |
| <b>Catalog Number</b>  |                    |                      |                        |                    |
| 66                     | 55-BU              | 50-BU                | 52-BU                  | 65-BU              |
| <b>Standard Length</b> |                    |                      |                        |                    |
| —                      | 50 feet            | 25 feet              | 18 inches              | —                  |

### Sectional Fanning Strips



Strap Screw

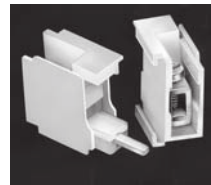

Tubular Screw

| Description              | Standard Package | Part No.    | Catalog No. |
|--------------------------|------------------|-------------|-------------|
| Tubular Screw            | 50               | 1-1437382-4 | 74          |
| Strap Screw              | 50               | 1-1437382-7 | 78-TB       |
| Molding Only, no contact | 50               | 4-1437393-1 | 74100       |



**Note:** All part numbers are RoHS Compliant.

**Medium Duty Channel Mount**

**Dovetail Base Mounted On Standard #60 Channel**

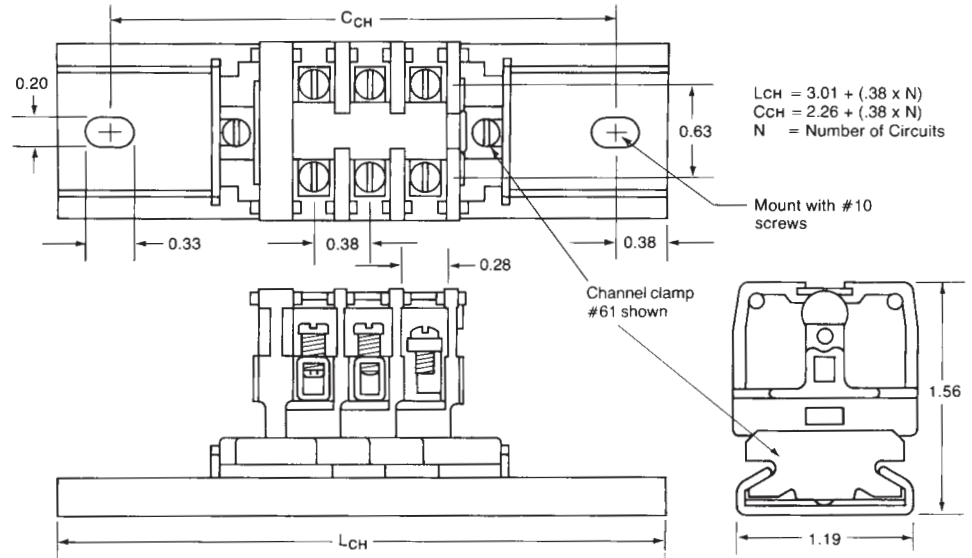

**Flat Base Mounted On Miniature #12 Channel**

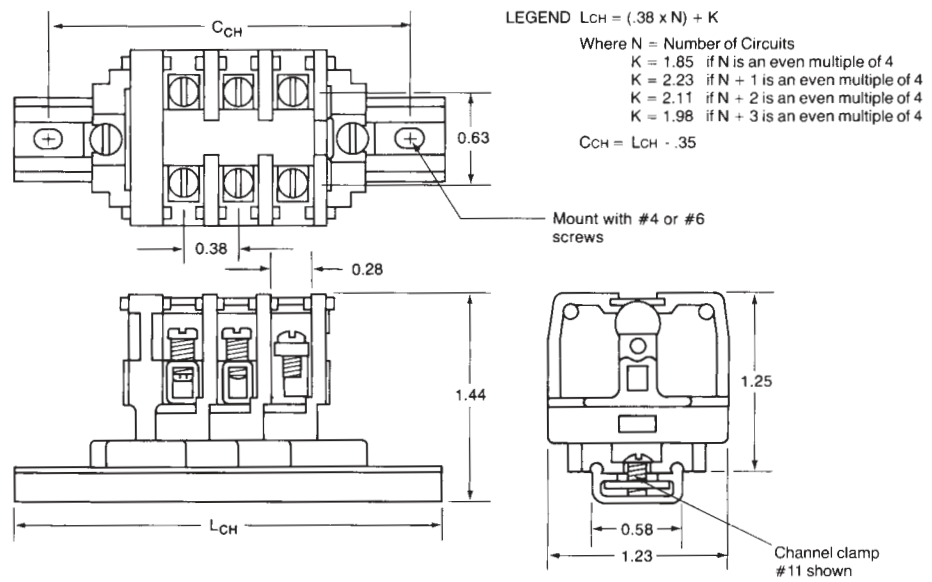

**Note:** All part numbers are RoHS Compliant.

**900 Series, Flat Base**

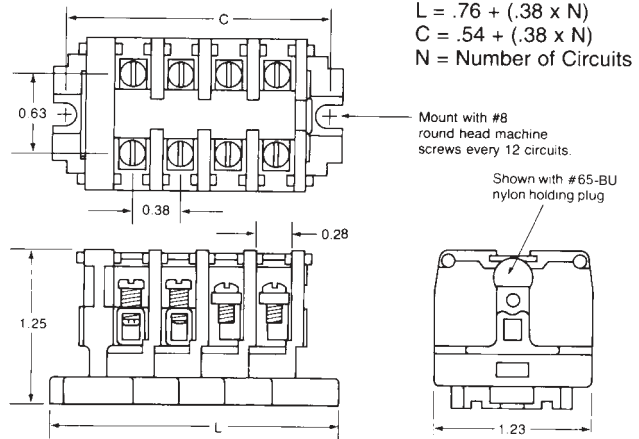
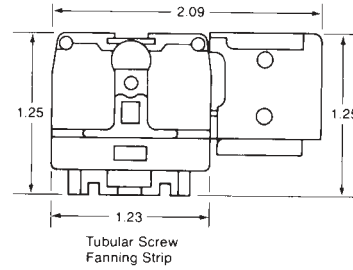
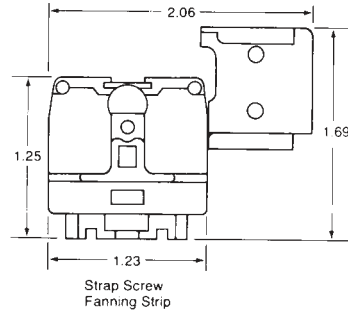

**Note:** All part numbers are RoHS Compliant.

**BP Series, Plug-in Blocks**

**Dovetail Base Mounted On Standard #60 Channel**

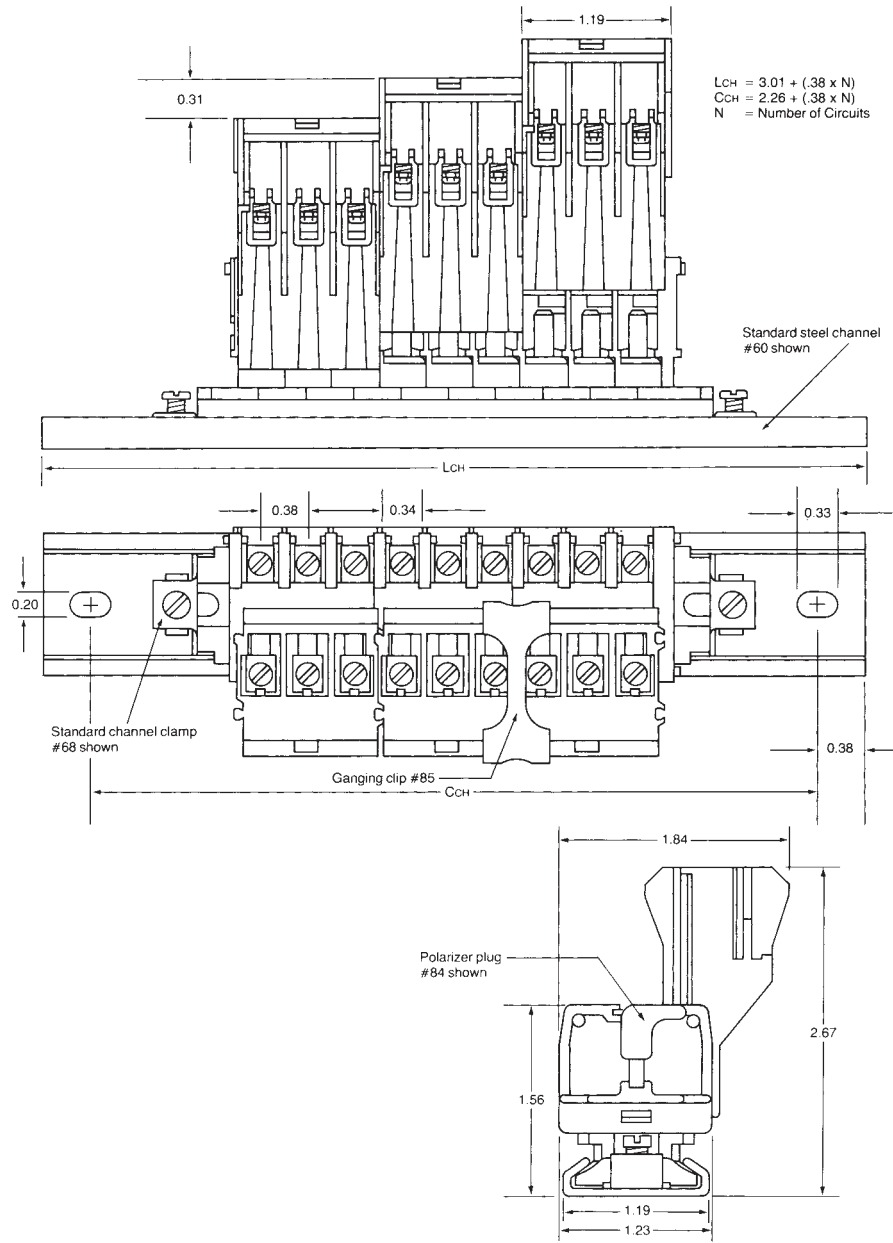

NEMA Terminal Blocks **6**

**Note:** All part numbers  
are RoHS Compliant.

---

## Engineering Notes

---



## 200 Series Heavy Duty

### Product Facts

- n Choose from 5 different contact styles.
- n 600 volt UL and NEMA rating.
- n Conservatively rated from 50 to 90 amperes per circuit, depending on which contact style is selected.
- n Choose any of three mounting methods — two-way flat base models surface mount directly to the panel or snap-on miniature channel. Dovetail base models mount on standard channel.
- n Packaged for rapid handling and assembly — snap-fit sections are packed 10 per carton.
- n Only one end section needed per block assembly.
- n Readily identify circuits — mark directly on block sections or use removable marking strip. Pre-printed strips are also available.

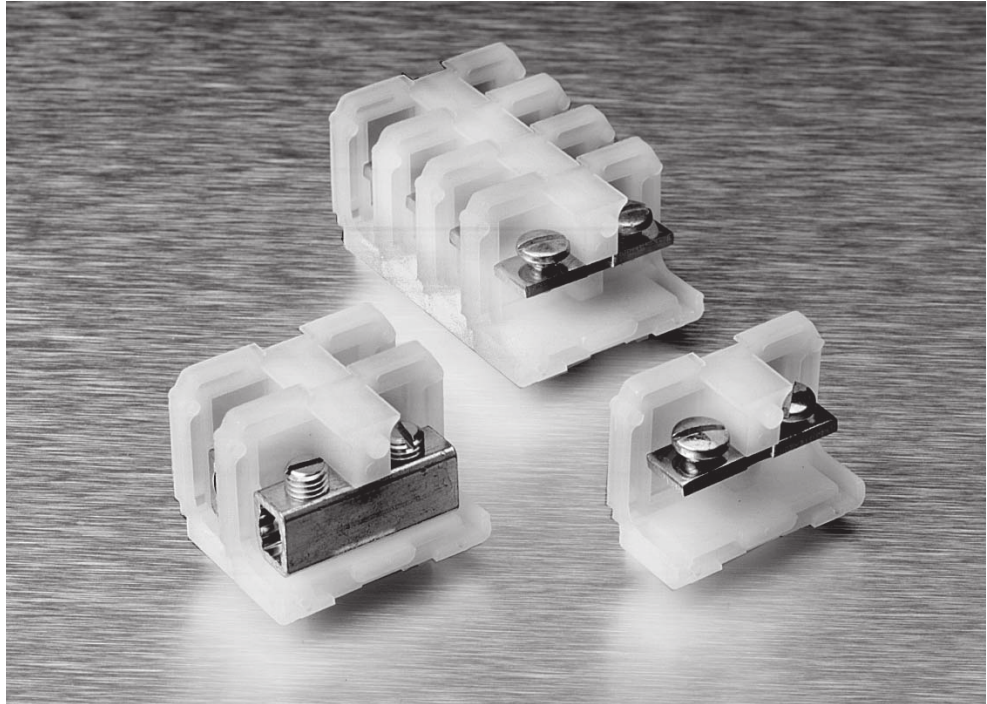

This compact, heavy duty block line accepts single or combination wires up to #4 AWG, solid or stranded. The compact design allows at least 138 circuits per 6-foot length to be mounted. The pitch of this 600 volt block is 0.50" [12.70] (centerline spacing).

**Note:** All part numbers are RoHS Compliant.

**200 Series, Heavy Duty, 600V, 0.50" [1.27] Pitch**

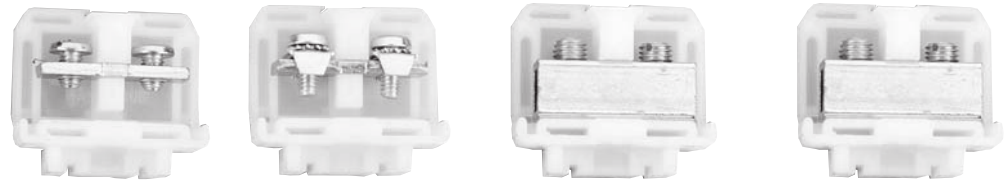

**Characteristics**                      **Strap Screw**                      **Strap Clamp**                      **Tubular Screw**                      **Tubular Clamp**

| Type of Block                        | Model | Part Number | Model | Part Number | Model | Part Number | Model    | Part Number |
|--------------------------------------|-------|-------------|-------|-------------|-------|-------------|----------|-------------|
| <b>Direct Mount (Flat Base)</b>      |       |             |       |             |       |             |          |             |
| Nylon, Unpainted                     | 241   | 3-1437390-9 | 248   | 4-1437390-2 | 242   | 4-1437390-0 | 243      | 4-1437390-1 |
| Polypropylene                        | P241  | 6-1437390-5 | P248  | 6-1437390-8 | P242  | 6-1437390-6 | P243     | 6-1437390-7 |
| <b>Channel Mount (Dovetail Base)</b> |       |             |       |             |       |             |          |             |
| Nylon, Painted                       | 0241  | 1-1437390-6 | 0248  | 2-1437390-4 | 0242  | 2-1437390-0 | 0243     | 2-1437390-1 |
| Polypropylene                        | P0241 | 5-1437390-9 | P0248 | 6-1437390-3 | P0242 | 6-1437390-0 | P0243-BU | 6-1437390-2 |

**Contact Type**



**Specifications**

|                                      |                       |                  |                     |                     |
|--------------------------------------|-----------------------|------------------|---------------------|---------------------|
| Wire Range (AWG)<br>Solid & Stranded | 22-10                 | 18-8             | 18-4                | 18-6                |
| Wire Strip Length (in.)              | —                     | 1/2              | 1/2                 | 1/2                 |
| Screw Type                           | 10-32<br>binding head | 8-32<br>pan head | 1/4-28<br>set screw | 1/4-28<br>set screw |
| Ampacity                             | 35 A                  | 50 A             | 85 A                | 65 A                |

**End Sections**

|                              |       |             |       |             |       |             |       |             |
|------------------------------|-------|-------------|-------|-------------|-------|-------------|-------|-------------|
| Direct Mount, Nylon          | 250   | 4-1437390-3 | 250   | 4-1437390-3 | 250   | 4-1437390-3 | 250   | 4-1437390-3 |
| Direct Mount, Polypropylene  | P250  | 6-1437390-6 | P250  | 6-1437390-6 | P250  | 6-1437390-6 | P250  | 6-1437390-6 |
| Channel Mount, Nylon         | 0250  | 2-1437390-5 | 0250  | 2-1437390-5 | 0250  | 2-1437390-5 | 0250  | 2-1437390-5 |
| Channel Mount, Polypropylene | P0250 | 6-1437390-4 | P0250 | 6-1437390-4 | P0250 | 6-1437390-4 | P0250 | 6-1437390-4 |

**Notes:**

For factory assembled blocks, suffix Catalog Number with number of blocks desired. See page 264-266 for dimensions and other details. (Maximum number of flat base preassembled sections is 12).  
Example: Ten tubular clamp, dovetail based sections, preassembled on channel = 024310

Example: Twelve polypropylene strap clamp flat base sections = P24812

For unpainted factory assembled blocks supplied with a removable marking strip add — 1 to Catalog Number.

For blocks with two or more different contact sections, imprinted marking strips, or special features, consult Technical Support.

**Comparison (Type of Block)**



**Direct Mount  
(Flat Base)**



**Channel Mount  
(Dovetail Base)**



**Note:** All part numbers are RoHS Compliant.

**200 Series, Heavy Duty, 600V, 0.50" [1.27] Pitch** (Continued)





**Corrosion Resistant Strap Screw**



**Corrosion Resistant Tubular Screw**

| Model  | Part Number | Model  | Part Number |
|--------|-------------|--------|-------------|
| D241   | 4-1437389-0 | D242   | 4-1437389-1 |
| DP241  | 1776721-1   | DP242  | 1776723-1   |
| D0241  | 1776722-1   | D0242  | 1776724-1   |
| DP0241 | 6-1437389-0 | DP0242 | 1776724-2   |

|   |   |
|---|---|
|  |  |
| 22-10   | 18-4  |
| —   | 1/2   |
| 10-32 Nickel plated binding head  | 1/4-28 Nickel plated set screw  |
| 35 A  | 85 A  |

|       |             |       |             |
|-------|-------------|-------|-------------|
| 250   | 4-1437390-3 | 250   | 4-1437390-3 |
| P250  | 6-1437390-6 | P250  | 6-1437390-6 |
| O250  | 2-1437390-5 | O250  | 2-1437390-5 |
| P0250 | 6-1437390-4 | P0250 | 6-1437390-4 |



**Note:** All part numbers are RoHS Compliant.

## 200 Series Heavy Duty Accessories

### Mounting Channel

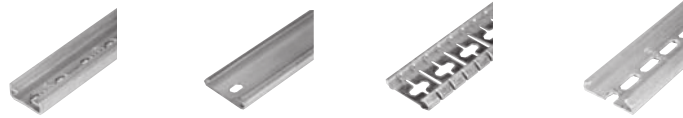

| Miniature              |                | Steel Channel              |                | Break Away Steel |                | Pre-punched Aluminum Channel |                |
|------------------------|----------------|----------------------------|----------------|------------------|----------------|------------------------------|----------------|
| Part Number            | Catalog Number | Part Number                | Catalog Number | Part Number      | Catalog Number | Part Number                  | Catalog Number |
| 1437381-8              | 12             | 9-1437381-1<br>9-1437381-8 | 60<br>63-BU    | 9-1437381-2      | 60-B-36        | 9-1437381-9<br>1437382-2     | 64<br>67       |
| <b>Standard Length</b> |                |                            |                |                  |                |                              |                |
| 3 feet                 |                | 6 feet<br>3 feet           |                | 3 feet           |                | 6 feet<br>3 feet             |                |

### Channel Clamps

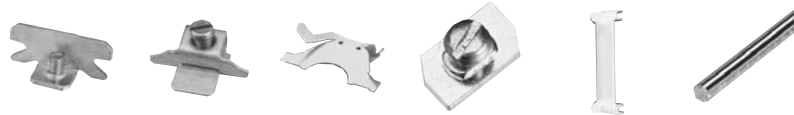

| Screw Channel Clamps   | Universal Clamps | Snap-In Clamps | Miniature for #12 Channel | See-thru Cover | Ganging Rod |
|------------------------|------------------|----------------|---------------------------|----------------|-------------|
| <b>Part Number</b>     |                  |                |                           |                |             |
| 9-1437381-5            | 1437382-3        | 9-1437381-7    | 1437381-4                 | 1-1437381-6    | 3-1437381-9 |
| <b>Catalog Number</b>  |                  |                |                           |                |             |
| 61                     | 68               | 62             | 11                        | 23-BU          | 30-BU       |
| <b>Standard Length</b> |                  |                |                           |                |             |
| —                      |                  |                |                           |                | 2 feet      |

### Marking Accessories



### Jumpers



| Plastic Cloth Tape     | Plastic Cloth Tape | Vinyl Marking Strips | Elevated Marking Strip | Nylon Holding Plug | Jumper for Tubular Contacts | Snap-Apart for Tubular Contacts |
|------------------------|--------------------|----------------------|------------------------|--------------------|-----------------------------|---------------------------------|
| <b>Part Number</b>     |                    |                      |                        |                    |                             |                                 |
| 8-1437381-1            | 8-1437381-0        | 6-1437381-3          | 4-1437391-1            | 4-1437393-0        | 2-1437393-4                 | 1-1437382-5                     |
| <b>Catalog Number</b>  |                    |                      |                        |                    |                             |                                 |
| 56                     | 55-BU              | 50-BU                | 52-BU                  | 65-BU              | 42-BU                       | 75                              |
| <b>Standard Length</b> |                    |                      |                        |                    |                             |                                 |
| —                      |                    | 50 feet              | 25 feet                | 18 inches          | —                           |                                 |
|                        |                    |                      |                        |                    |                             | 12 ckt                          |

### Related Product Data

**Wire Pins and Ferrules**—Pages 109-111  
For more information on AMP Standard Terminals and Splices or Quick-Connect FASTON Receptacles and Tabs, request Catalog 82042.





**Note:** All part numbers are RoHS Compliant.

## 200 Series Heavy Duty Specifications

### Material & Finish

**Voltage Rating:** Blocks meet 600 volt creepage and clearance requirements of NEMA, UL and CSA for general industrial control equipment and panelboards. Withstand voltages greatly in excess of IEEE switchgear standards for 750 volts.

**Ampacity:** For a single #4 AWG wire the maximum amperage recommended is 85 amps.

### Standard Contacts:

**Material:** Electrical grade copper or copper alloy conductor. Steel Screws plated to resist corrosion in most industrial applications

**AL-CU Tubular Screw:** Aluminum compatibility with aluminum or copper conductors. AL-CU is tin-plated brass.

### Environmental Contacts (for highly corrosive atmospheres)

**Tubular Screw:** Electrical grade copper tube with nickel plating. Nickel plated brass screws.

**Strap Screw:** Nickel plated brass straps and screws. Nickel plating exceeds specification QQ-N-290 Class I, Type VII.

### Nylon Housing:

**Material—**Nylon; Unfilled Type 6/6

**Max. Continuous Temperature—**125°C [257°F]

### Breakdown Voltage (AC, 60 Hz)—

Contact-to-Contact: 7000V

Contact-to-Ground: 7800V

**Dielectric Strength (RH 40% at Sea Level)—**470-385 Volts/mil thickness Per ASTM D149

**UL High Voltage Arc Tracking (inches/min.)—**.01-.35

**Water Absorption (24 hrs. % wt. gain)—**1.5%

**Flammability—**UL94V-2

**Chemical Resistance—**Resistant to aromatic hydrocarbons, strong alkalis Per ASTM D543

**Radiation Resistance (ergs g-1 (C)—**8 x 10<sup>7</sup>

**Color—**Translucent White

### Independent Testing Service Listing and Recognition

WIRE SIZES, Solid or Stranded

Tubular Screw

1 #4 AWG, 1 #6 AWG,

1 or 2 #8 AWG, 1 to 4 #10 AWG,

1 or 5 #12 AWG, 1 to 4 #14 AWG,

1 or 6 #16 AWG, 1 to 8 #18 AWG,

Tubular Clamp

1 #6 AWG, 1 or 2 #8 AWG,

1 to 3 #10 AWG, 1 to 4 #12 AWG,

1 or 4 #14 AWG, 1 to 6 #16 AWG,

1 or 8 #18 AWG

Strap Clamp

1 #18 to 1 #8 AWG

### Polypropylene Housing:

**Material—**Polypropylene; Filled self-extinguishing

**Max. Continuous Temperature—**105°C (221°F)

### Breakdown Voltage (AC, 60Hz)—

Contact-to-Ground: 7800V

Contact-to-Contact: 7000V

**Dielectric Strength (RH 40% at Sea Level)—**500 Volts/mil thickness Per ASTM D149

**UL High Voltage Arc Tracking (inches/min.)—**Did not Track

**Water Absorption (24 hrs. % wt. gain)—**0.02% Per ASTM D570

**Flammability—**UL94V-0

**Chemical Resistance—**Resistant to most acids, alkalines, and saline solutions. Also resistant to higher aliphatic solvents and polar substances per ASTM D543

**Radiation Resistance (ergs g-1 (C)—**No data Available

**Color—**Opaque White



LR25557



E63810

**Note:** All part numbers are RoHS Compliant.

**200 Series, 600 Volt, Direct Mount**

**Flat Base**

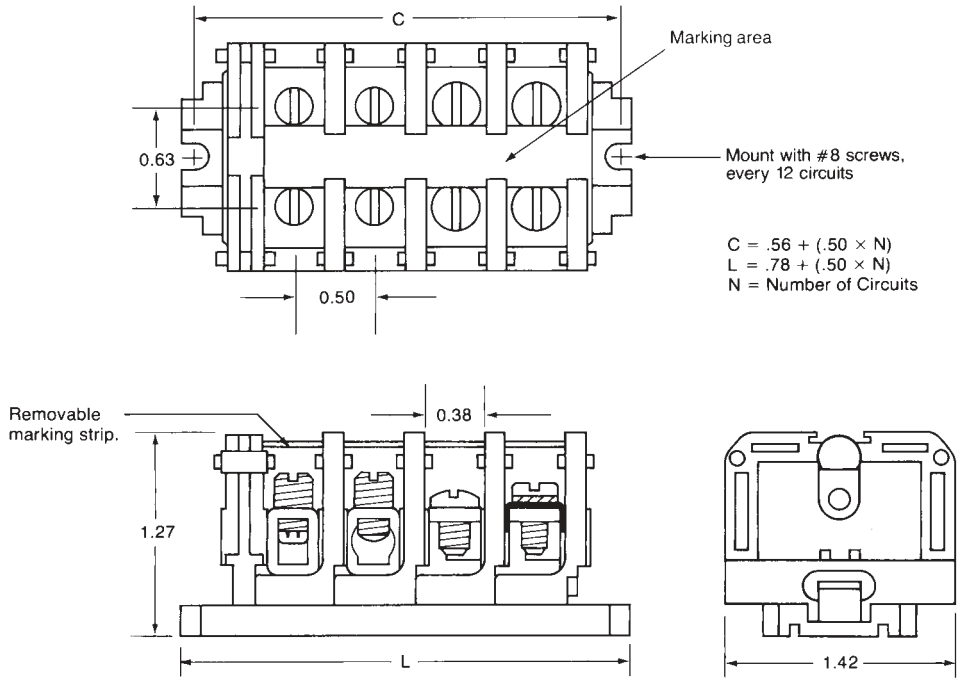

**Note:** All part numbers are RoHS Compliant.

**200 Series, 600 Volt, Channel Mount**

**Flat Base Mounted On #12 Miniature Channel**

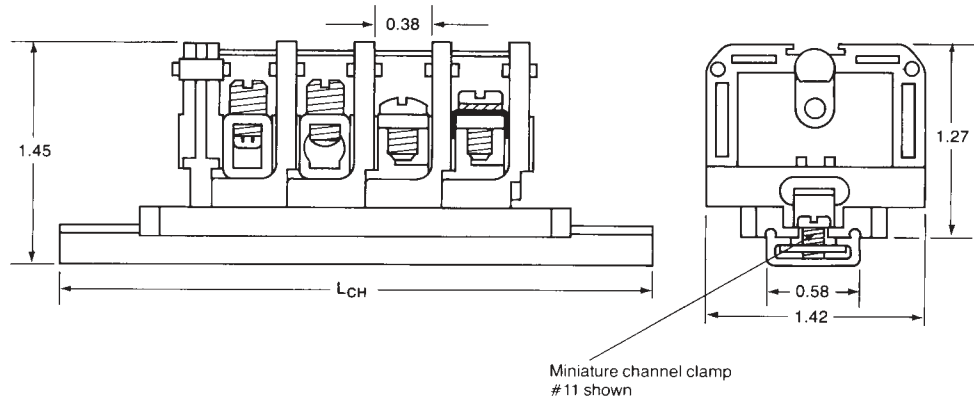
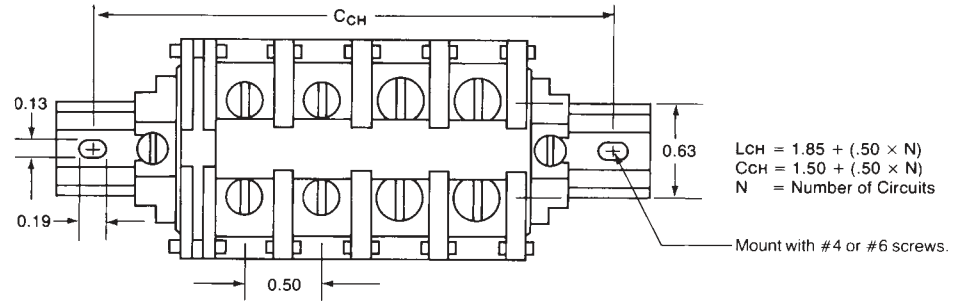

**Note:** All part numbers are RoHS Compliant.

**200 Series, 600 Volt, Channel Mount (Standard)**

**Dovetail Base Mounted On Standard #60 Channel**

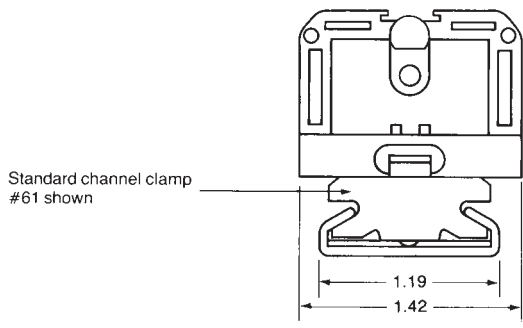
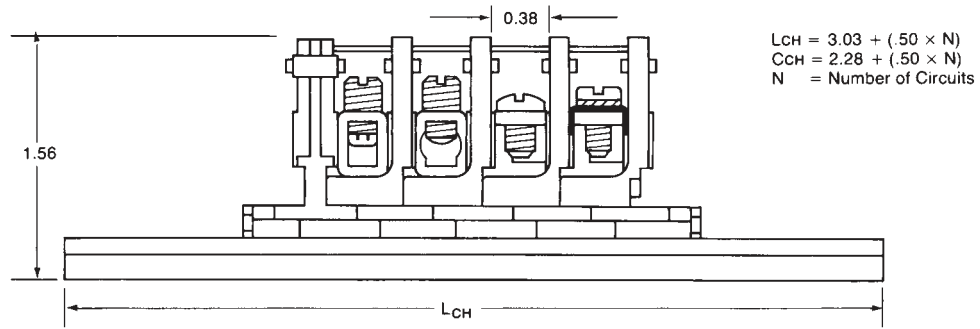
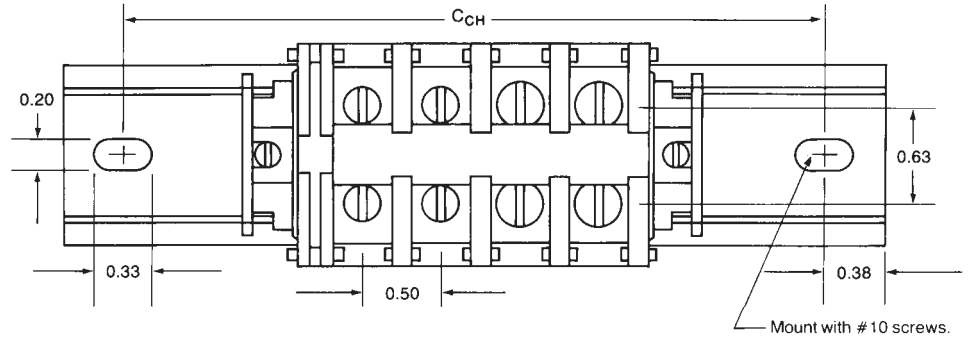

## 200 Series, Heavy Duty Phenolic Blocks

### Product Facts

- n **Sturdy Heavy Duty block accepts single or combinations of wire up to #4 AWG solid or stranded — at least 122 circuits per 6-foot length, 9/16" center-to-center spacing.**
- n **Choose from four different contact styles conservatively rated up to 90 amperes.**
- n **600 volt UL and NEMA rating.**
- n **Surface mounted flat base and channel mounted dovetail base models available.**
- n **Only one end section needed per block assembly.**
- n **Interlocking sectional fanning strips allow entire circuit groups to be connected and disconnected as a single unit.**
- n **Readily identify circuits — available with painted marking surface or use removable marking strip. Pre-printed strips are also available.**
- n **Factory assembled blocks available.**
- n **Heavy Duty Phenolic Block Sections Snap-fit with 300 & 600 volt, medium duty phenolic, heavy duty nylon and polypropylene, and Fuse and Switch blocks.**

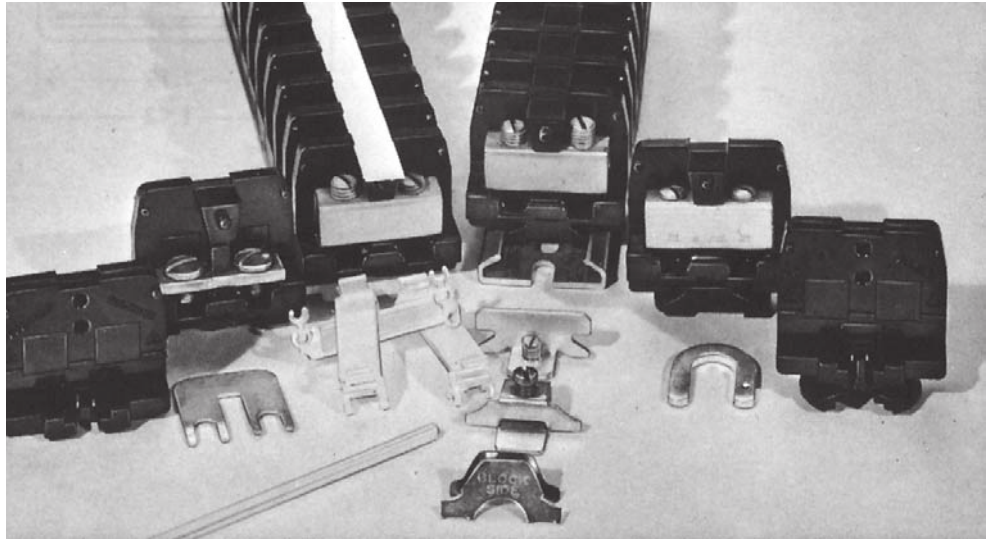

This family of phenolic heavy duty blocks is ideal for high temperature, high current applications. The rugged material withstands temperatures up to 302°F [150°C].

**Note:** All part numbers are RoHS Compliant.

**200 Series, Heavy Duty Phenolic, 600 V, 0.56" [14.24] Pitch**

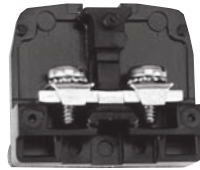

**Characteristics**

**Strap Screw**

**Strap Clamp**

**Tubular Screw**

**Tubular Clamp**

| Type of Block                        | Model | Part Number | Model  | Part Number | Model  | Part Number | Model  | Part Number |
|--------------------------------------|-------|-------------|--------|-------------|--------|-------------|--------|-------------|
| <b>Direct Mount (Flat Base)</b>      |       |             |        |             |        |             |        |             |
| Painted                              | 221   | 3-1437390-1 | 228-BU | 1-1437381-5 | 222-BU | 3-1437390-3 | 223-BU | 3-1437390-6 |
| Unpainted                            | 211   | 2-1437390-7 | 218    | 3-1437390-0 | 212    | 2-1437390-8 | 213    | 2-1437390-9 |
| <b>Channel Mount (Dovetail Base)</b> |       |             |        |             |        |             |        |             |
| Painted                              | 0221  | 1437390-8   | 0228   | 1-1437390-3 | 0222   | 1437390-9   | 0223   | 1-1437390-2 |
| Unpainted                            | 0211  | 1437390-1   | 0218   | 1437390-7   | 0212   | 1437390-3   | 0213   | 1437390-5   |
| <b>Contact Type</b>                  |       |             |        |             |        |             |        |             |



**Specifications**

|                                      |                       |                          |                     |                     |
|--------------------------------------|-----------------------|--------------------------|---------------------|---------------------|
| Wire Range (AWG)<br>Solid & Stranded | 22-10                 | 18-8                     | 18-4                | 18-6                |
| Wire Strip Length (in.)              | —                     | 1/2                      | 1/2                 | 1/2                 |
| Screw Type                           | 10-32<br>binding head | 8-32<br>pan head w/clamp | 1/4-28<br>set screw | 1/4-28<br>set screw |
| Ampacity                             | 35 A                  | 50 A                     | 85 A                | 65 A                |
| <b>End Sections</b>                  |                       |                          |                     |                     |
| Direct Mount                         | 230-BU 1-1437381-7    | 230-BU 1-1437381-7       | 230-BU 1-1437381-7  | 230-BU 1-1437381-7  |
| Channel Mount                        | 0230 1-1437390-4      | 0230 1-1437390-4         | 0230 1-1437390-4    | 0230 1-1437390-4    |

**Notes:**

For factory assembled blocks, suffix Catalog Number with number of blocks desired. See page 272 for dimensions and other details. (Maximum number of flat base preassembled sections is 12).

Example: Twenty dovetail based, tubular clamp blocks, preassembled on channel = 021320 (plain marking area)

Example: Twelve preassembled flat base, strap screw blocks = 22112 (painted marking area)

For factory assembled blocks supplied with a removable marking strip add — 1 to Catalog Number.

For blocks with two or more different contact sections, imprinted marking strips, or special features, consult Technical Support.

Environmental contacts for highly corrosive atmospheres are available with nickel plating on non-ferrous hardware. To order, prefix Catalog # with "D".

**Comparison (Type of Block)**

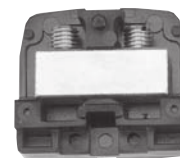

**Direct Mount (Flat Base)**

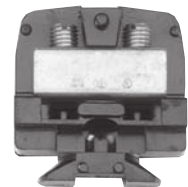

**Channel Mount (Dovetail Base)**



**Note:** All part numbers are RoHS Compliant.

**200 Series, Heavy Duty Phenolic, 600 V, 0.56" [14.24] Pitch (Continued)**



**Corrosion Resistant Strap Screw**



**Corrosion Resistant Tubular Screw**



**Corrosion Resistant Tubular Clamp**

| Model | Part Number | Model | Part Number | Model | Part Number |
|-------|-------------|-------|-------------|-------|-------------|
| D221  | 3-1437389-6 | D222  | 3-1437389-8 | D223  | 3-1437389-9 |
| D211  | 3-1437389-4 | D212  | 3-1437389-5 | D213  | 4-1437390-6 |
| D0221 | 1437389-7   | D0222 | 1437389-8   | D0223 | 1437389-9   |
| D0211 | 1437389-2   | D0212 | 1437389-4   | D0213 | 1437389-6   |

**Contact Type**



**Specifications**

|                                  |                                |                                |
|----------------------------------|--------------------------------|--------------------------------|
| 22-10                            | 18-4                           | 22-10                          |
| —                                | 1/2                            | 1/2                            |
| 10-32 Nickel plated binding head | 1/4-28 Nickel plated set screw | 1/4-28 Nickel plated set screw |
| 35 A                             | 85 A                           | 65 A                           |
| 230-BU 1-1437381-7               | 230-BU 1-1437381-7             | 230-BU 1-1437381-7             |
| 0230 1-1437390-4                 | 0230 1-1437390-4               | 0230 1-1437390-4               |

NEMA Terminal Blocks **6**

**Sectional Fanning Strips**

| Description              | Part No.    | Catalog No. |
|--------------------------|-------------|-------------|
| Tubular Screw            | 1-1437381-8 | 24          |
| Strap Screw              | 1-1437381-9 | 27          |
| Molding Only, no contact | 1447889-1   | 2400        |

**Note:**

For factory assembled fanning strips, suffix Catalog Number with number desired.

Example: Ten factory assembled sections of #24 = 2410

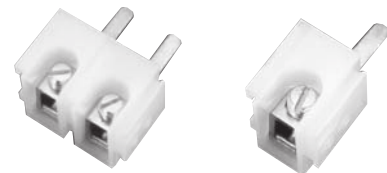

**Note:** All part numbers are RoHS Compliant.

## 200 Series, Heavy Duty Phenolic Accessories

### Mounting Channel

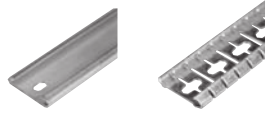

### Channel Clamps



| Steel Channel              | Break Away Steel | Pre-punched Aluminum Channel | Screw Channel Clamps | Universal Clamps | Snap-In Clamps | See-thru Cover | Ganging Rod |
|----------------------------|------------------|------------------------------|----------------------|------------------|----------------|----------------|-------------|
| <b>Part Number</b>         |                  |                              |                      |                  |                |                |             |
| 9-1437381-1<br>9-1437381-8 | 9-1437381-2      | 9-1437381-9<br>1437382-2     | 9-1437381-5          | 1437382-3        | 9-1437381-7    | 1-1437382-2    | 3-1437381-9 |
| <b>Catalog Number</b>      |                  |                              |                      |                  |                |                |             |
| 60<br>63-BU                | 60-B-36          | 64<br>67                     | 61                   | 68               | 62             | 23-BU          | 30-BU       |
| <b>Standard Length</b>     |                  |                              |                      |                  |                |                |             |
| 6 feet<br>3 feet           | 3 feet           | 6 feet<br>3 feet             | —                    | —                | —              | —              | 2 feet      |

### Marking Accessories



### Jumpers



| Plastic Cloth Tape     | Plastic Cloth Tape | Vinyl Marking Strips | Elevated Marking Strip | Nylon Holding Plug | Jumper for Tubular Contacts | Jumper for Strap Screw |
|------------------------|--------------------|----------------------|------------------------|--------------------|-----------------------------|------------------------|
| <b>Part Number</b>     |                    |                      |                        |                    |                             |                        |
| 8-1437381-1            | 8-1437381-0        | 6-1437381-3          | 4-1437391-1            | 4-1437393-0        | 2-1437393-3                 | 5-1437381-5            |
| <b>Catalog Number</b>  |                    |                      |                        |                    |                             |                        |
| 56                     | 55-BU              | 50-BU                | 52-BU                  | 65-BU              | 41-BU                       | 43                     |
| <b>Standard Length</b> |                    |                      |                        |                    |                             |                        |
| 10 sheets              | 50 feet            | 25 feet              | 18 inches              | —                  | —                           | —                      |

### Related Product Data

**Wire Pins and Ferrules**—Pages 109-111  
 For more information on AMP Standard Terminals and Splices or Quick-Connect FASTON Receptacles and Tabs, request Catalog 82042.



## 200 Series, Heavy Duty Phenolic Specifications

### Material & Finish

#### Standard Contacts

**Material:** Electrical grade copper or copper alloy conductor. Steel Screws plated to resist corrosion in most industrial applications.

#### Environmental Contacts (for highly corrosive atmospheres)

**Tubular Screw:** - Electrical grade copper tube with nickel plating.

Nickel plated brass screws.

**Strap Screw:** - Nickel plated brass straps and screws

Nickel plating exceeds specification QQ-N-290 Class I, Type VII.

**Wire Range:** Strap Screw: #22-10 AWG max., solid or stranded with crimp terminals

**Strap Clamp:** #18-8 AWG, solid or stranded

**Tubular Screw:** #18-4 AWG, solid or stranded

**Tubular Clamp:** #18-6 AWG, solid or stranded

**Wire Strip Length:** Strap Screw: As needed for lugging

**Strap Clamp:** 1/2 in. [12.7]

**Tubular Screw:** 1/2 in. [12.7]

**Tubular Clamp:** 1/2 in. [12.7]

**Screw Type:** Strap Screw: 10-32 slotted binding head

**Strap Clamp:** 8-32 pan head w/ clamp

**Tubular Screw:** 1/4-28 slotted headless

**Tubular Clamp:** 1/4-28 slotted headless

**Strap Screw:** Maximum width of lugs: 11/32 in. [8.73]

### Independent Testing Service Listing and Recognition

WIRE SIZES, Solid or Stranded Tubular Screw

Tubular Screw

1 #4 AWG, 1 #6 AWG,

1 or 2 #8 AWG, 1 to 4 #10 AWG,

1 or 5 #12 AWG, 1 to 6 #14 AWG,

1 or 6 #16 AWG, 1 to 8 #18 AWG,

Tubular Clamp

1 #6 AWG, 1 or 2 #8 AWG,

1 to 3 #10 AWG, 1 to 4 #12 AWG,

1 or 4 #14 AWG, 1 to 6 #16 AWG,

1 or 8 #18 AWG

Strap Clamp

1 #18 to 1 #8 AWG

### Nylon Housing

**Material**—Phenolic, Filled Flame Retardant

**Max. Continuous Temperature**—150°C, [302°F]

**Breakdown Voltage**—

Contact-to-Contact: 7800V

Contact-to-Ground: 9400V

**Dielectric Strength (RH 40% at Sea Level)**—300 Volts/mil thickness per ASTM #D149

**UL High Voltage Arc Tracking (Inches/min.)**—.49-.58 [12.45-14.73]

**Water Absorption (24 hrs. % wt. gain)**—0.45% per ASTM D570

**Flammability**—UL94V-1

**Chemical Resistance**—Resistant to acids, alkalis, and aliphatic hydrocarbons and ketones, per ASTM D543.

**Radiation Resistance (ergs g-1 (C))**—2.7 x 108 min.

**Color**—Black



LR25557



E63810

**Note:** All part numbers are RoHS Compliant.

**200 Series, Heavy Duty Phenolic**

**Flat Base**

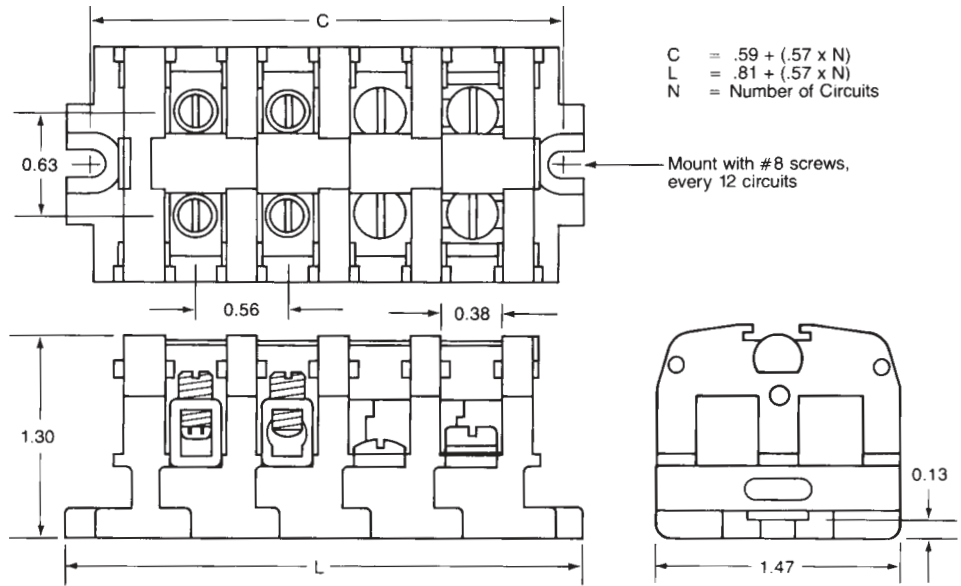

**Dovetail Base Mounted On Standard #60 Channel**

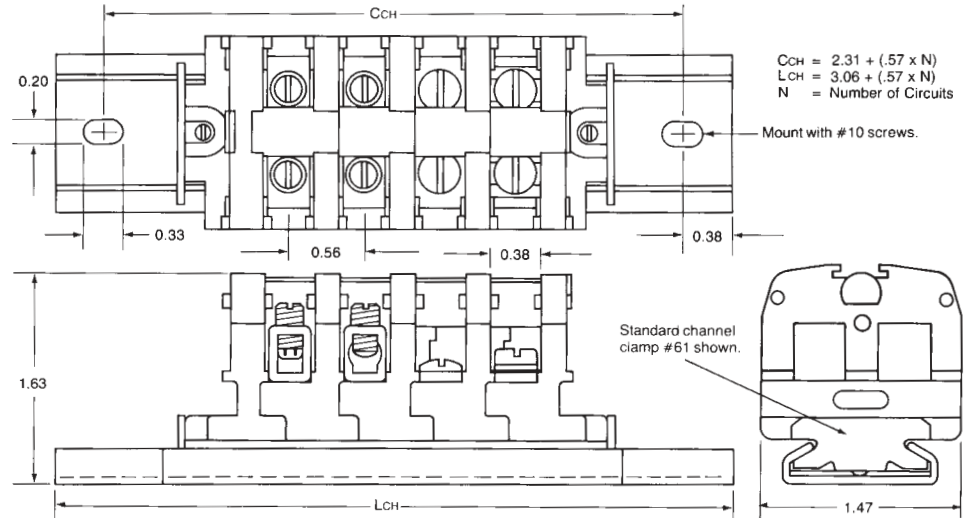

**Sectional Fanning Strips**

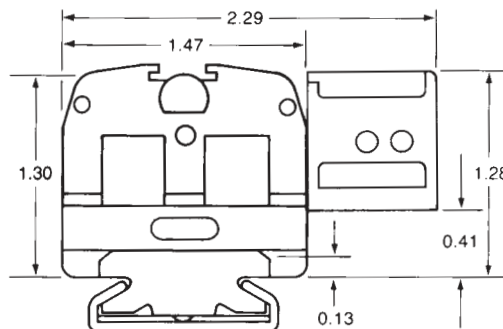

## 800 Series, Intermediate Heavy Duty

### Product Facts

- n An exceptionally compact block that accepts single or combinations of AWG wire sizes as large as #1/0 — at least 92 circuits per 6-foot length, 3/4 inch center-to-center spacing.
- n Tubular screw contact style accepts AWG wire sizes from #12 thru #1/0, solid or stranded.
- n Same block mounts on surface or channel — two-way mounting base fits standard channel or mounts directly to flat surfaces.
- n Packaged for rapid handling and assembly — snap-fit sections packaged 10 per carton.
- n Contacts conservatively rated at 155 amperes per circuit when used with copper wire.
- n Only one end section needed per block assembly.
- n Readily identify circuits — blocks available with painted marking surface or use removable vinyl marking strip. Preprinted marking strips are also available.
- n Factory assembled blocks available.
- n Nylon housing material for the most rugged applications.
- n Allen head screw for aluminum wire — screw tip design helps protect aluminum wire from overtightening. Slotted screw head for copper wire.
- n Intermediate Heavy Duty blocks snap-fit with 300 & 600V, Medium Duty phenolic, Heavy Duty nylon, polypropylene and phenolic and Fuse and Switch blocks.

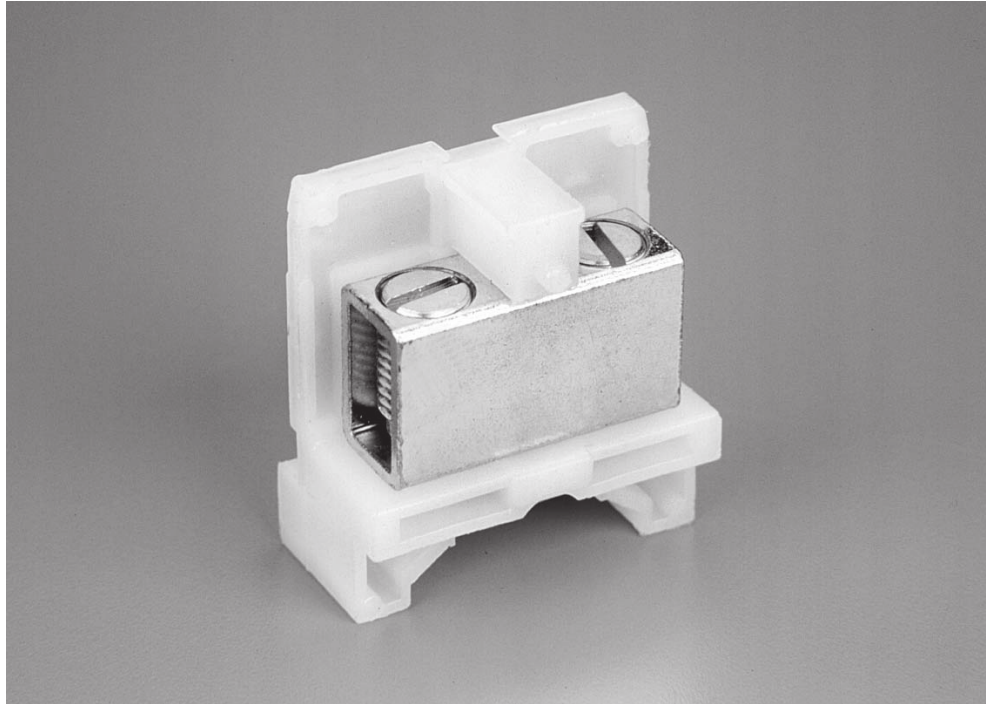

This line of 600 volt blocks is rated up to 150 A and is available in a standard version and a corrosion resistant version.

## 800 Series, Intermediate Heavy Duty, 600 V, 0.75" Pitch

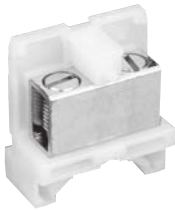

### Material & Finish

**Housing Material**—Polyamide type 6/6, unfilled

**Max Continuous Temp.**—125°C [257°F]

**Water Absorption (24hrs. % wt. gain)**—1.5%

**Flammability**—UL94V-2

**Chemical Resistance**—Resistant to aromatic hydrocarbons, strong alkalis

**Radiation Resistance (ergs g-1 (C))**—8 x 10<sup>7</sup>

**Color**—Translucent white

### Electrical Properties

**Voltage Rating**—Blocks meet 600V clearance and creepage requirements of NEMA, UL, and CSA standards for general industrial control equipment and panelboards. Withstand voltages in excess of IEEE switchgear standards for 750V.

**Breakdown Voltage, AC, 60Hz**—  
Contact-to-Contact: 8,800V  
Contact-to-Ground: 9000V

**Dielectric Strength — RH 40% @ Sea Level**—470-385 Volts/mil thickness per ASTM D149

**Operating Voltage**—Blocks meet 600V creepage and clearance requirements; withstand voltage greatly exceeds standards for 750V

**UL High Voltage Arc Tracking (in./min.)**—0.1-.35 [25-8.89]

### Contacts

#### Standard Contacts

**Material**—Electrical grade copper conductor

**Screws**—Steel, zinc plated to resist corrosion in most applications

#### Duramax Contacts (for highly corrosive atmospheres)

**Tubular Screw**—Electrical grade copper tube with nickel plating; nickel plated brass screws. Nickel plating exceeds specification QQ-N-290 Class 1, Type VII.

**Wire Range**—#12-1/0 AWG, solid or stranded

**Wire Strip Length**—11/16" [17.46]

**Screw Type**—7/16" [11.11] - 20 slotted headless screw

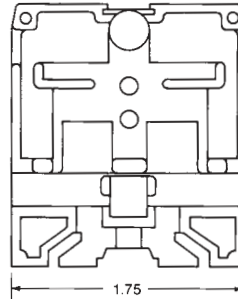

Same part used for both panel and channel mounting.

| Description                    | Part No.    | Catalog No. |
|--------------------------------|-------------|-------------|
| Tubular Screw, Unpainted       | 1437395-2   | 814         |
| Tubular Screw, Painted         | 1437395-3   | 824-BU      |
| Corrosion Resistant, Unpainted | 5-1437389-8 | D814-BU     |
| Corrosion Resistant, Painted   | 5-1437389-9 | D824        |
| End Section                    | 1-1437395-4 | 830-BU      |

#### Notes:

For factory assembled blocks on channel, prefix Catalog # with "0" and suffix with number of blocks desired. Without channel (maximum of 6 sections) delete "0". See page 275 for dimensions and other details.

Example: Ten tubular screw sections preassembled on channel = 082410

For unpainted factory assembled blocks supplied with a removable marking strip add -1 to Catalog Number.

For blocks with two or more different contact sections, imprinted marking strips or special features; consult Technical Support.

### Independent Testing Service Listing and Recognition

**UL Wire Sizes**—Solid or Stranded, Tubular Screw

1 — #1/0 AWG, 1 — #1 AWG

1 — #2 AWG, 1 or 2 — #4 AWG

1, 2 or 3 — #6 AWG,

1, 2, 3 or 5 — #8 AWG

1 to 6 — #10 AWG, 1 to 7 — #12 AWG



LR25557

E63810

**Note:** All part numbers are RoHS Compliant.

## 800 Series, Intermediate Heavy Duty Accessories

### Mounting Channel

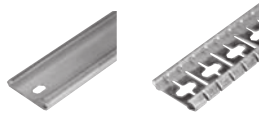

### Channel Clamps



| Steel Channel              | Break Away Steel | Pre-punched Aluminum Channel | Screw Channel Clamps | Universal Clamps | Snap-In Clamps | See-thru Cover | Ganging Rod |
|----------------------------|------------------|------------------------------|----------------------|------------------|----------------|----------------|-------------|
| <b>Part Number</b>         |                  |                              |                      |                  |                |                |             |
| 9-1437381-1<br>9-1437381-8 | 9-1437381-2      | 9-1437381-9<br>1437382-2     | 9-1437381-5          | 1437382-3        | 9-1437381-7    | 4-1437390-4    | 3-1437381-9 |
| <b>Catalog Number</b>      |                  |                              |                      |                  |                |                |             |
| 60<br>63-BU                | 60-B-36          | 64<br>67                     | 61                   | 68               | 62             | 93-BU          | 30-BU       |
| <b>Standard Length</b>     |                  |                              |                      |                  |                |                |             |
| 6 feet<br>3 feet           | 3 feet           | 6 feet<br>3 feet             | —                    | —                | —              | —              | 2 feet      |

### Marking Accessories



### Jumpers

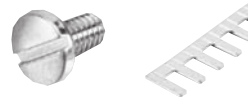

| Plastic Cloth Tape     | Plastic Cloth Tape | Vinyl Marking Strips | Elevated Marking Strip | Holding Screw | Snap-apart Jumper |
|------------------------|--------------------|----------------------|------------------------|---------------|-------------------|
| <b>Part Number</b>     |                    |                      |                        |               |                   |
| 1437382-1              | 8-1437381-0        | 6-1437381-3          | 4-1437391-1            | 7-1437381-8   | 1-1437382-6       |
| <b>Catalog Number</b>  |                    |                      |                        |               |                   |
| 66                     | 55-BU              | 50-BU                | 52                     | 53-BU         | 76                |
| <b>Standard Length</b> |                    |                      |                        |               |                   |
| —                      | 50 feet            | 25 feet              | 18 inches              | —             | 12 ckt            |

### RELATED PRODUCT DATA

**WIRE PINS AND FERRULES:** Pages 109-111  
 For more information on AMP Standard Terminals and Splices or Quick-Connect FASTON Receptacles and Tabs, request Catalog 82042.

**Note:** All part numbers are RoHS Compliant.

**800 Series, Intermediate Heavy Duty**

**Flat Base**

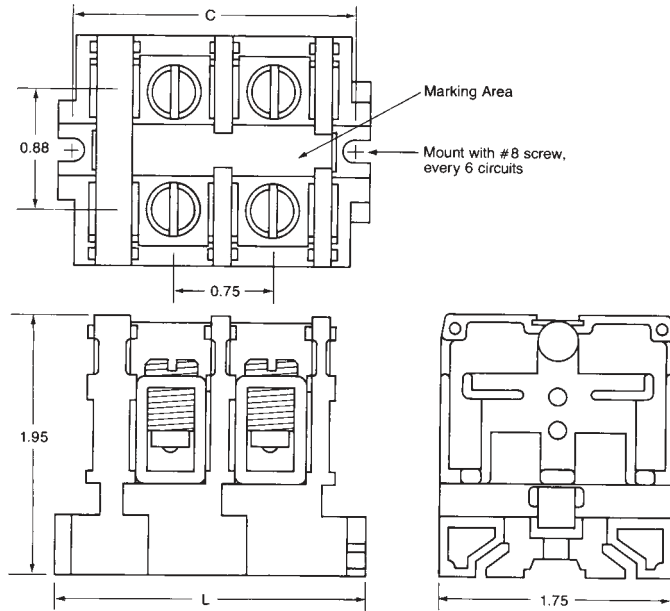

**Dovetail Base Mounted On Standard #60 Channel**

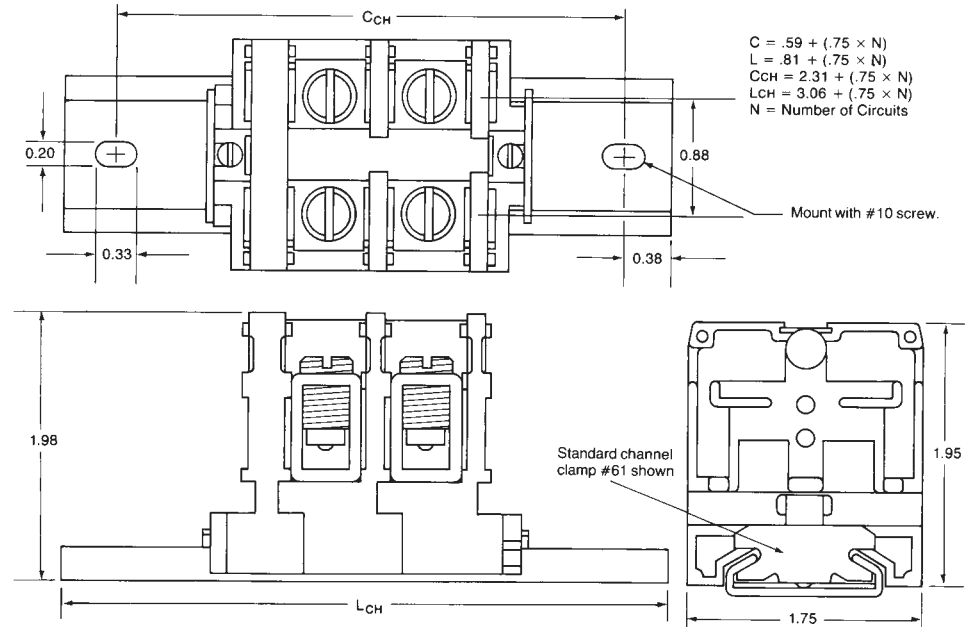

## 400 Series, Ultra Heavy Duty

### Product Facts

#### 400 Series

- Compact 2/0 or 250 kcmil (MCM) block - at least 57 circuits per 6-foot length, 1-3/16" [30.16] center-to-center spacing.
- High current capacity snap-fit sectional block — tubular contacts accept single or combinations of wire sizes as large as 250 kcmil (MCM).
- Two contact styles available; rated up to 270 amperes for copper wire.
- Allen head screws allow maximum torque when using large wire sizes.
- Withstand voltages in excess of IEEE switchgear standards for 750 volts. Meet clearance and creepage spacing specified in UL, CSA, and NEMA Industrial Control Standards for 600 volts.
- Same block directly mounts on surface or channel mounts.
- Only one end section needed per block assembly.
- Readily identify circuits—order blocks with painted marking area or use removable vinyl marking strip. Preprinted marking strips are also available.
- Factory assembled blocks available.
- Ultra Heavy Duty phenolic block sections do not snap-fit with other block styles.

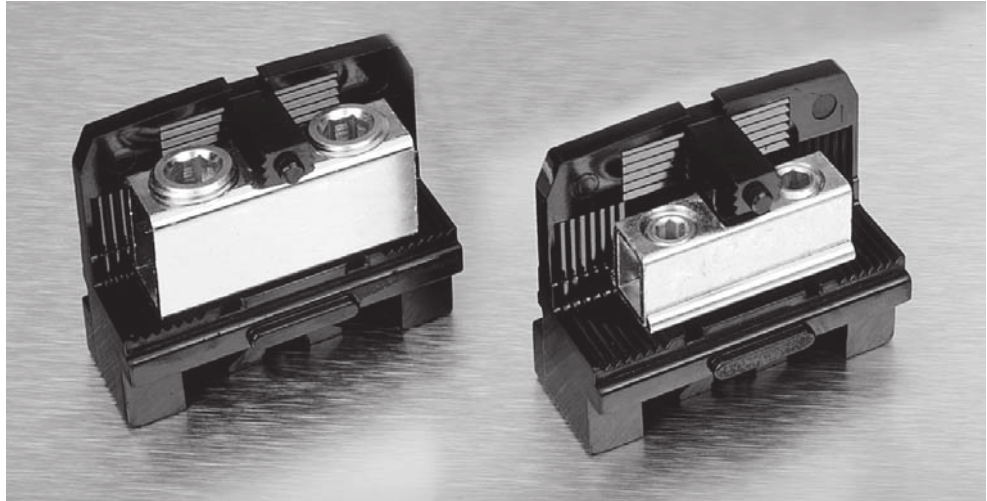

This Ultra Heavy Duty line includes the 400 Series rated up to 270 A.

**400 Series, Ultra Heavy Duty, 600 V, 1.19" [30.23] Pitch**

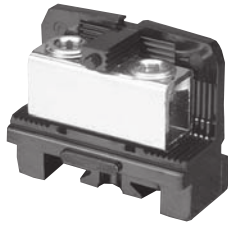

**Material & Finish**

**Housing Material**—Phenolic, filled flame retardant

**Flammability**—UL94V-1

**Color**—Black

**Contacts:**

**Material**—Electrical grade copper conductor; plated steel screws resist corrosion

**Tubular Screw Type**—

- Small: 1/2" [12.7] - 13 Hex
- Large: 3/4" [19.05] - 16 Hex socket set screw

**Mechanical Properties**

**Pitch (terminal spacing)**—1.19" [30.23]; 9 circuits/foot

**Wire Strip Length**—  
Tubular Screw (small): 1" [25.4]  
Tubular Screw (large): 1" [25.4]

**Electrical Properties**

**Maximum Current**—255A for a single 250MCM wire

**Operating Voltage**—Blocks meet 600V creepage and clearance requirements; withstand voltage greatly exceeds standards for 750V

**Wire Range**—Tubular Screw (small): #4-#2/0 AWG solid or stranded; Tubular Screw (large): #6 AWG-250 kcmil (MCM) solid or stranded

**Dielectric Strength (RH 40% @ sea level)**—300 V/mil thickness per ASTM D149

**Breakdown Voltage, AC, 60Hz**—  
Contact-to-Contact: 10,000V  
Contact-to-Ground: 10,000V

**UL High Voltage Arc Tracking (in./min.)**—49-.58 [12.45-14.73]

**Environmental Properties**

**Max. Continuous Temperature**—150°C [302°F]

**Water Absorption (24hrs. % wt. gain)**— .45% per ASTM D149

**Chemical Resistance**—Resistant to acids, alkalis, and aliphatic hydrocarbons and ketones per ASTM D543

**Radiation Resistance (ergs g-1 (C))**—2.7 x 108

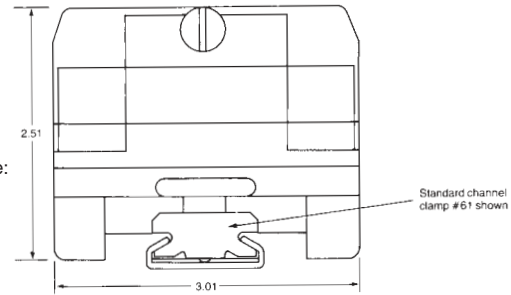
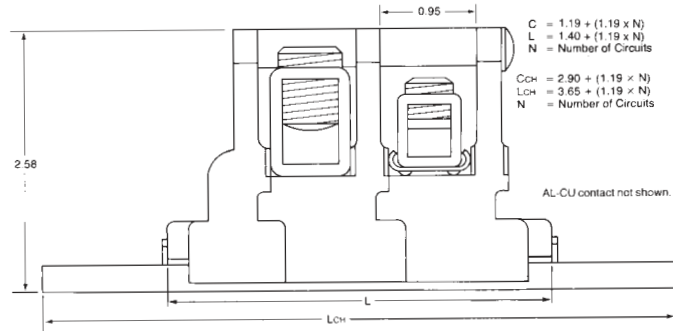
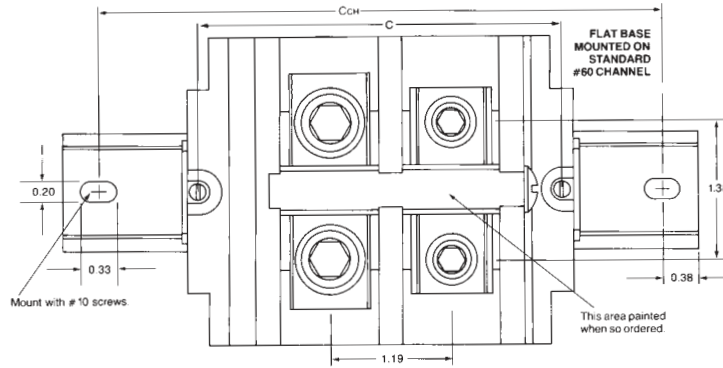

**Note:** For Direct Mounting, use #10 pan head screws every six circuits. recommended torque: 15-20 in.-lbs.

**Same part used for both panel and channel mounting.**

| Description              | Wire Range       | Part Number | Catalog Number |
|--------------------------|------------------|-------------|----------------|
| Tubular Screw, Unpainted | #14-2/0          | 1437396-4   | 416            |
| Tubular Screw, Painted   | #14-2/0          | 1437396-7   | 426-BU         |
| Tubular Screw, Unpainted | #6-250 kcmil/MCM | 1437396-5   | 417            |
| Tubular Screw, Painted   | #6-250 kcmil/MCM | 1437396-8   | 427-BU         |
| End Section              | —                | 1437396-9   | 430-BU         |

**UL Independent Testing Service Recognitions:**

**Tubular Screw:** Catalog # 416 & 426-BU

- 1 #2/0 AWG, 1 #1/0 AWG, 1 #1 AWG,
- 1 or 2 #2 AWG, 1 to 3 #4 AWG, 1 to 3 #6 AWG,
- 1 to 4 #8 AWG, 1 to 6 #10 AWG, 2 to 8 #12 AWG,

**Tubular Screw:** Catalog # 417 & 427-BU

- 1 #250kcmil (MCM), 1 #4/0 AWG, 1 #3/0 AWG,
- 1 or 2 #2/0 AWG, 1 or 2 #1/0 AWG, 1 or 2 #1 AWG, 1 to 3 #2 AWG, 1 to 4 #4 AWG,
- 1 to 5 #6 AWG





**Note:** All part numbers are RoHS Compliant.

## 400 Series, Ultra Heavy Duty Accessories

### Mounting Channel

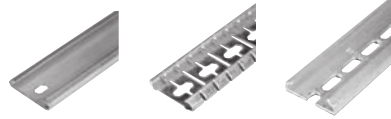

### Channel Clamps



| Steel Channel              | Break Away Steel | Pre-punched Aluminum Channel | Screw Channel Clamps | Universal Clamps | Snap-In Clamps |
|----------------------------|------------------|------------------------------|----------------------|------------------|----------------|
| <b>Part Number</b>         |                  |                              |                      |                  |                |
| 9-1437381-1<br>9-1437381-8 | 9-1437381-2      | 9-1437381-9<br>1437382-2     | 9-1437381-5          | 1437382-3        | 9-1437381-7    |
| <b>Catalog Number</b>      |                  |                              |                      |                  |                |
| 60<br>63-BU                | 60-B-36          | 64<br>67                     | 61                   | 68               | 62             |
| <b>Standard Length</b>     |                  |                              |                      |                  |                |
| 6 feet<br>3 feet           | 3 feet           | 6 feet<br>3 feet             | —                    | —                | —              |

### Marking Accessories



| Plastic Cloth Tape     | Vinyl Marking Strips | Elevated Marking Strip | Holding Screw |
|------------------------|----------------------|------------------------|---------------|
| <b>Part Number</b>     |                      |                        |               |
| 8-1437381-0            | 6-1437381-3          | 4-1437391-1            | 7-1437381-8   |
| <b>Catalog Number</b>  |                      |                        |               |
| 55-BU                  | 50-BU                | 52-BU                  | 53-BU         |
| <b>Standard Length</b> |                      |                        |               |
| 50 feet                | 25 feet              | 18 inches              | —             |

**Notes:**

For factory assembled blocks on channel, prefix Catalog # with "0" and suffix with number of blocks desired. Without channel (maximum of 6 sections) delete "0".

Example: Ten tubular screw sections preassembled on channel = 041710

For unpainted factory assembled blocks supplied with a removable marking strip add -1 to Catalog Number.

For blocks with two or more different contact sections, imprinted marking strips or special features, consult Technical Support.

### Related Product Data

**Wire Pins and Ferrules**—Pages 109-111  
For more information on AMP Standard Terminals and Splices or Quick-Connect FASTON Receptacles and Tabs, request Catalog 82042.

**Note:** All part numbers  
are RoHS Compliant.

---

**Engineering Notes**

---

## Fuse & Switch

### Product Facts

#### High Density Blocks

- Fuse and Switch Blocks rated 15A and 300V.
- High Density 0.36" [9.14] centerline spacing saves panel space; at least 33 circuits per foot.

#### Fuse Blocks

- Provide in-line circuit protection for virtually any circuit or group of circuits — select contacts for terminated or unterminated wire.
- Remove, check and replace fuses safely and quickly — switch action fuse blocks open circuits before fuse can be removed or installed.
- Contacts conservatively rated to 30 amperes.

#### Switch Blocks

- Quickly and easily interrupt a circuit or group of circuits — insert switch blocks directly in line. Contacts available for terminated or unterminated wire.
- Keep circuits open for extended periods — switch blade can be removed entirely from block for lock-out protection.
- Rated to 15 amperes.

#### Common Features of 300 & 0300 Series

- At least 91 circuits per 6-foot length, 3/4 inch center-to-center spacing.
- Blocks meet 600 volt clearance and creepage spacings specified in UL, CSA, and NEMA Industrial Control Standards.
- Choose nylon housing material — for more rugged applications; polypropylene for fire retardant characteristics.
- Dovetail base fits standard mounting channel — can also be mounted on flat surfaces.
- Only one end section needed per block assembly.

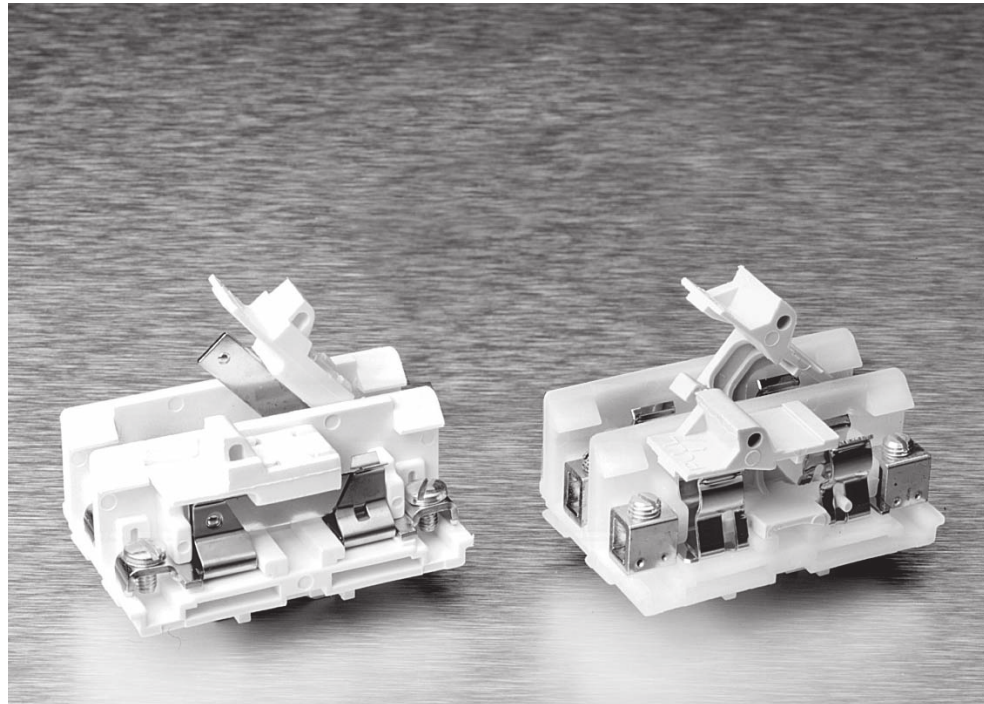

- Readily identify circuits — mark directly on white, matte-surface puller assembly, marking tab on block, or use removable marking tape.
- Open or close several circuits simultaneously — holes in puller handles allow use of nylon “ganging” rods.
- Fuse and Switch block sections snap-fit with 300 & 600 Volt, phenolic Medium Duty, Heavy Duty, and Intermediate Heavy Duty blocks.

This broad line features High Density Blocks (Series 0135), Nylon & Polypropylene Blocks (Series 0300) and Phenolic Blocks (Series 300).



LR25557



E63810

## 0300 Series, Fuse & Switch, Nylon and Polypropylene

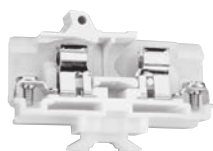

**Fuse Block  
Strap Screw**

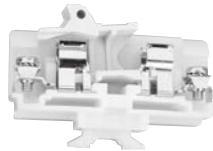

**Fuse Block  
Strap Clamp**

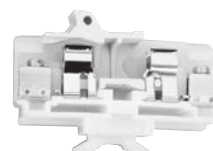

**Fuse Block  
Tubular Screw**

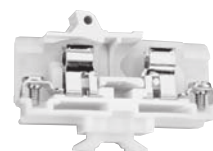

**Switch Block  
Strap Screw**

**Characteristics**

| Type of Block                        | Model  | Part Number | Model  | Part Number | Model  | Part Number | Model  | Part Number |
|--------------------------------------|--------|-------------|--------|-------------|--------|-------------|--------|-------------|
| <b>Channel Mount (Dovetail Base)</b> |        |             |        |             |        |             |        |             |
| Nylon                                | 0311   | 1437397-1   | 0318   | 1437397-3   | 0312   | 1437397-2   | 0371   | 1-1437397-7 |
| Polypropylene                        | P0311  | 4-1437397-0 | P0318  | 4-1437397-3 | P0312  | 4-1437397-2 | P0371  | 4-1437397-4 |
| Corrosion Resistant Nylon            | D0311  | 1-1437389-1 | D0318  | 1776726-1   | D0312  | 1-1437389-2 | D0371  | 1-1437389-7 |
| Corrosion Resistant Polypropylene    | DP0311 | 6-1437389-2 | DP0318 | 1776727-1   | DP0312 | 6-1437389-3 | DP0371 | 1776728-1   |

**Contact Type**



**Specifications**

|                                      |                       |                          |                      |                       |
|--------------------------------------|-----------------------|--------------------------|----------------------|-----------------------|
| Wire Range (AWG)<br>Solid & Stranded | 22-8                  | 18-8                     | 18-8                 | 22-8                  |
| Wire Strip Length (in.)              | —                     | 1/2                      | 1/2                  | —                     |
| Screw Type                           | 10-32<br>binding head | 8-32<br>pan head w/clamp | 1/4"-28<br>set screw | 10-32<br>binding head |

**Ampacity**

|      |      |      |      |
|------|------|------|------|
| 25 A | 25 A | 25 A | 15 A |
|------|------|------|------|

**End Sections**

|                              |       |             |       |             |       |             |       |             |
|------------------------------|-------|-------------|-------|-------------|-------|-------------|-------|-------------|
| Channel Mount, Nylon         | 0380  | 2-1437397-0 | 0380  | 2-1437397-0 | 0380  | 2-1437397-0 | 0380  | 2-1437397-0 |
| Channel Mount, Polypropylene | P0380 | 4-1437397-7 | P0380 | 4-1437397-7 | P0380 | 4-1437397-7 | P0380 | 4-1437397-7 |

**Notes:** Standard package is 100 pieces for contact, 25 pieces for end section.

For factory assembled blocks on channel, suffix Catalog Number with number of blocks desired. Without channel delete "0" prefix on Catalog Number.

EXAMPLE:

Ten strap-screw fuse block sections preassembled on channel = 031110.

For blocks with two or more contact types, preassembled with other blocks, imprinting or special features, consult Technical Support.

**Note:** All part numbers are RoHS Compliant.

**0300 Series, Fuse & Switch, Nylon and Polypropylene (Continued)**

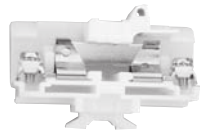

**Switch Block  
Strap Clamp**

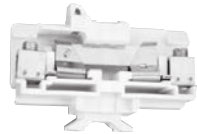

**Switch Block  
Tubular Screw**

| Model  | Part Number | Model  | Part Number |
|--------|-------------|--------|-------------|
| 0378   | 1-1437397-9 | 0372   | 1-1437397-8 |
| P0378  | 4-1437397-6 | P0372  | 4-1437397-5 |
| D0378  | 1776729-1   | D0372  | 1776731-1   |
| DP0378 | 1776730-1   | DP0372 | 1776732-1   |



|                          |                      |       |             |
|--------------------------|----------------------|-------|-------------|
| 18-8                     | 18-8                 |       |             |
| 1/2                      | 1/2                  |       |             |
| 8-32<br>pan head w/clamp | 1/4"-28<br>set screw |       |             |
| 15 A                     | 15 A                 |       |             |
| 0380                     | 2-1437397-0          | 0380  | 2-1437397-0 |
| P0380                    | 4-1437397-7          | P0380 | 4-1437397-7 |

**Fuse Puller:**

|          |   |
|----------|---|
| Material | High-temperature,<br>glass-reinforced nylon |
| Color    | Black                                       |

**Switch Handle:**

|          |               |
|----------|---------------|
| Material | Polypropylene |
| Color    | White         |

**Specifications**

**Pitch**—0.75" [19.05] centerline, 16 circuits per foot

**Voltage Rating**—Blocks meet 600 volt creepage and clearance requirements of NEMA, UL and CSA for general industrial control equipment and panelboards. Withstand voltages greatly in excess of IEE switchgear standards for 750 volts.

**Fuse Size**—Any 13/32 x 1-1/2 in. [10.32 x 28.10] ferrule type cartridge fuse up to 25 amps, indicating or non-indicating, which meets Mil. Spec. F-15160.

**Standard Contacts**

**Material**—Electrical grade copper or copper alloy conductor. Steel Screws plated to resist corrosion in most industrial applications

**AL-CU Tubular Screw**—Aluminum compatibility with aluminum or copper conductors. AL-CU is tin-plated brass.

**Environmental Contacts  
(for highly corrosive atmospheres)**

**Tubular Screw**—Electrical grade copper tube with nickel plating. Nickel plated brass screws.

**Strap Screw**—Nickel plated brass straps and screws. Nickel plating meets specification QQ-N-290A Class I, Grade G.

**Polyamide Material:**

**Housing Material**—Polyamide, Unfilled Type 6/6

**Max. Continuous Temperature**—125°C, (257°F)

**Breakdown Voltage (AC, 60 Hz)**—

Contact-to-Contact: 7000V

Contact-to-Ground: 10,000V

**Dielectric Strength (RH 40% at Sea Level)**—470-385 Volts/mil thickness Per ASTM D149

**UL High Voltage Arc Tracking (inches/min.)**—0.1-0.35 [25-8.89]

**Water Absorption (24 hrs. % wt. gain)**—1.5% per ASTM D570

**Flammability**—UL94V-2

**Chemical Resistance**—Resistant to aromatic hydrocarbons, strong alkalies per ASTM D543

**Radiation Resistance (ergs g-1 (C))**—8 x 107

**Color**—Translucent White

**Polypropylene Material:**

**Housing Material**—Polypropylene, Filled self-extinguishing

**Max. Continuous Temperature**—105°C, (221°F)

**Breakdown Voltage (AC, 60Hz)**—

Contact-to-Ground: 10,000V

Contact-to-Contact: 7000V

**Dielectric Strength (RH 40% at Sea Level)**—500 Volts/mil thickness per ASTM D149

**UL High Voltage Arc Tracking (inches/min.)**—Did not track

**Water Absorption (24 hrs. % wt. gain)**—0.02% Per ASTM D570

**Flammability**—UL94V-0

**Chemical Resistance**—Resistant to most acids, alkalines, and saline solutions. Also resistant to higher aliphatic solvents and polar substances per ASTM D543

**Radiation Resistance (ergs g-1 (C))**—No data Available

**Color**—Opaque White

**Note:** All part numbers are RoHS Compliant.

**0300 Series, Fuse & Switch, Nylon and Polypropylene** (Continued)

**Mounting Channel**



| Steel Channel              | Break Away Steel | Pre-punched Aluminum Channel |
|----------------------------|------------------|------------------------------|
| <b>Part Number</b>         |                  |                              |
| 9-1437381-1<br>9-1437381-8 | 9-1437381-2      | 9-1437381-9<br>1437382-2     |
| <b>Catalog Number</b>      |                  |                              |
| 60<br>63-BU                | 60-B-36          | 64<br>67                     |
| <b>Standard Length</b>     |                  |                              |
| 6 feet<br>3 feet           | 3 feet           | 6 feet<br>3 feet             |

**Channel Clamps**

**Marking Accessories**



| Screw Channel Clamps   | Universal Clamps | Snap-In Clamps | Ganging Rod | Coated Cloth Marking tape |
|------------------------|------------------|----------------|-------------|---------------------------|
| <b>Part Number</b>     |                  |                |             |                           |
| 9-1437381-5            | 1437382-3        | 9-1437381-7    | 3-1437381-9 | 8-1437381-0               |
| <b>Catalog Number</b>  |                  |                |             |                           |
| 61                     | 68               | 62             | 30          | 55-BU                     |
| <b>Standard Length</b> |                  |                |             |                           |
| —                      | —                | —              | 2 feet      | 50 feet                   |

**Related Product Data**

**Wire Pins and Ferrules**—Pages 109-111  
For more information on AMP Standard Terminals and Splices or Quick-Connect FASTON Receptacles and Tabs, request Catalog 82042.

**Note:** All part numbers are RoHS Compliant.

**0300 Series, Fuse & Switch, Nylon and Polypropylene (Continued)**

**Dovetail Base Mounted On Standard #60 Channel. May Also Be Mounted Direct**

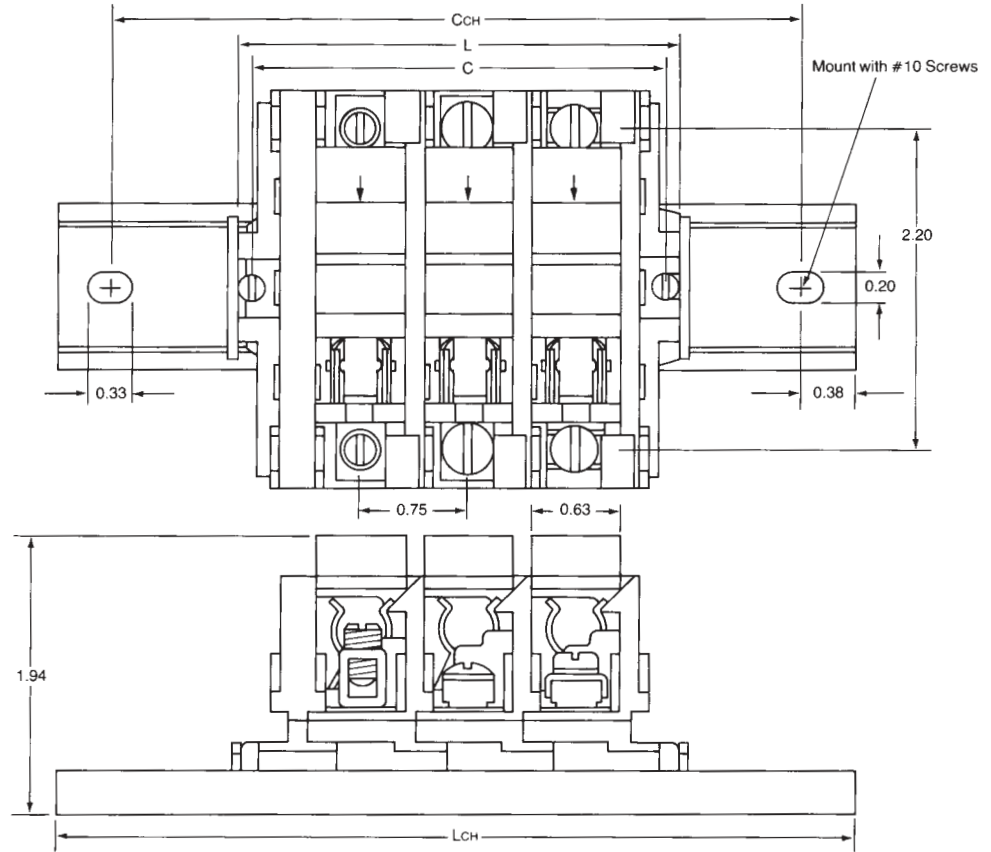

**CHANNEL MOUNTED**  
 $CCH = 2.28 + (.75 \times N)$   
 $LCH = 3.03 + (.75 \times N)$   
 N = Number of Circuits

**DIRECT MOUNTED**  
 $C = .56 + (.75 \times N)$   
 $L = .78 + (.75 \times N)$   
 N = Number of Circuits

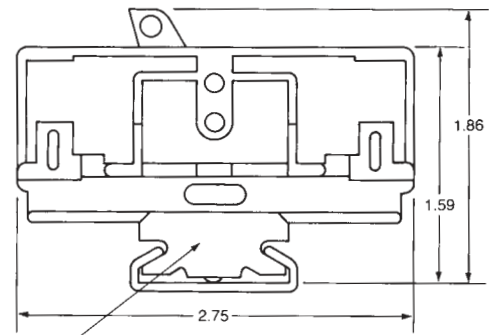

Standard Channel Clamp #61 Shown

**Note:** All part numbers are RoHS Compliant.

### 300 Series, Fuse & Switch, Phenolic

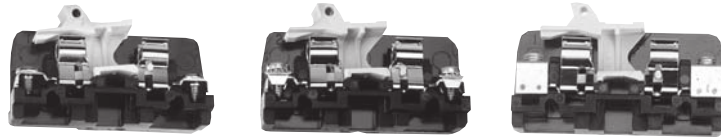

**Characteristics**

**Strap Screw**

**Strap Clamp**

**Tubular Screw**

| Type of Block                        | Model | Part Number | Model  | Part Number | Model  | Part Number |
|--------------------------------------|-------|-------------|--------|-------------|--------|-------------|
| <b>Direct Mount (Flat Base)</b>      |       |             |        |             |        |             |
| Fuse Block with Puller               | 351   | 2-1437397-8 | 358    | 3-1437397-1 | 352    | 3-1437397-0 |
| Fuse Block without Puller            | 361   | 2-1437397-2 | 368-BU | 3-1437397-5 | 362-BU | 3-1437397-3 |
| Switch Block                         | 341   | 2-1437397-5 | 348    | 2-1437397-7 | 342    | 2-1437397-6 |
| <b>Channel Mount (Dovetail Base)</b> |       |             |        |             |        |             |
| Fuse Block with Puller               | 0351  | 1437397-9   | 0358   | 1-1437397-2 | 0352   | 1-1437397-0 |
| Fuse Block without Puller            | 0361  | 1437397-4   | 0368   | 1-1437397-6 | 0362   | 1-1437397-5 |
| Switch Block                         | 0341  | 1437397-6   | 0348   | 1437397-8   | 0342   | 1437397-7   |

**Contact Type**



**Specifications**

|                                      |                      |                          |                      |
|--------------------------------------|----------------------|--------------------------|----------------------|
| Wire Range (AWG)<br>Solid & Stranded | 22-8                 | 18-8                     | 18-8                 |
| Wire Strip Length (in.)              | —                    | 1/2                      | 1/2                  |
| Screw Type                           | 8-32<br>binding head | 8-32<br>pan head w/clamp | 1/4"-28<br>set screw |

**Ampacity**

|               |     |     |     |
|---------------|-----|-----|-----|
| Fuse Blocks   | 25A | 25A | 25A |
| Switch Blocks | 15A | 15A | 15A |

**End Sections**

|                           |        |              |        |              |        |              |
|---------------------------|--------|--------------|--------|--------------|--------|--------------|
| No Contact, Flat Base     | 330-BU | 2-14376397-4 | 330-BU | 2-14376397-4 | 330-BU | 2-14376397-4 |
| No Contact, Dovetail Base | 0330   | 14376397-5   | 0330   | 14376397-5   | 0330   | 14376397-5   |

**Comparison (Type of Block)**



**Direct Mount  
(Flat Base)**

**Channel Mount  
(Dovetail Base)**

**Notes:** Standard package is 10 pieces.

For factory assembled blocks, suffix Catalog Number with number of blocks desired (Maximum number of flat base preassembled sections is 6).

EXAMPLE:

Twelve strap screw, fuse block sections preassembled on channel = 035112.

Six flat tubular screw, switch blocks preassembled without channel for direct mounting = 3426

For blocks with two or more different contact sections, preassembled with other blocks, imprinting or special features, consult Technical Support.

Environmental contacts for highly corrosive atmospheres are available with Nickel plating on non-ferrous hardware. To order, prefix Catalog Number with "D".

Except  
Switch  
Blocks



LR25557



E34934



**Note:** All part numbers are RoHS Compliant.

**300 Series, Fuse & Switch, Phenolic—Accessories**

**Mounting Channel**

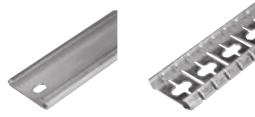

**Fuse Puller**



| Steel Channel              | Break Away Steel | Pre-punched Aluminum Channel | Fuse Puller | 3-Gang Fuse Puller |
|----------------------------|------------------|------------------------------|-------------|--------------------|
| <b>Part Number</b>         |                  |                              |             |                    |
| 9-1437381-1<br>9-1437381-8 | 9-1437381-2      | 9-1437381-9<br>1437382-2     | 2-1437397-1 | 2-1437397-2        |
| <b>Catalog Number</b>      |                  |                              |             |                    |
| 60-BU<br>63-BU             | 60-B-36          | 64<br>67                     | 31-BU       | 32                 |
| <b>Standard Length</b>     |                  |                              |             |                    |
| 6 feet<br>3 feet           | 3 feet           | 6 feet<br>3 feet             | —           | —                  |

**Channel Clamps**



**Marking Accessories**

| Screw Channel Clamps   | Universal Clamps | Snap-In Clamps | Ganging Rod | Coated Cloth Marking Tape |
|------------------------|------------------|----------------|-------------|---------------------------|
| <b>Part Number</b>     |                  |                |             |                           |
| 9-1437381-5            | 1437382-3        | 9-1437381-7    | 3-1437381-9 | 8-1437381-0               |
| <b>Catalog Number</b>  |                  |                |             |                           |
| 61                     | 68               | 62             | 30          | 55-BU                     |
| <b>Standard Length</b> |                  |                |             |                           |
| —                      | —                | —              | 2 feet      | 50 feet                   |

**Physical Properties**

**Housing Material**—Phenolic, filled flame retardant  
**Color**—Black

**Contacts**

**Material**—Copper alloy spring clips. Steel screws plated to resist corrosion in most industrial applications

**Strap Screw**—11/32" max. lug width

**Mechanical Properties**

**Pitch (terminal spacing)**—0.75" [19.05] (16 circuits per foot)

**Switch Handles**

**Material**—Polypropylene

**Color**—White

**Electrical Properties**

**Operating Voltage**—Blocks meet 600V creepage and clearance requirements of NEMA, UL and CSA standards for general industrial control equipment and panelboards; withstand voltage exceeds IEEE switchgear standards for 750V

**Dielectric Strength (RH 40% @ sea level)**—300 volts/mil thickness per ASTM D149

**UL High Voltage Arc Tracking (inches/min.)**—.49-.58 [12.45-14.73]

**Fuse Size**—Any 13/32 x 1-1/2 in. [10.32 x 38.10] ferrule type cartridge fuse up to 25 amps, indicating or non-indicating, which meets Mil. Spec. F-15160, is recommended.

**Environmental Properties**

**Max. Service Temperature**—150°C (302°F)

**Water Absorption (24hrs. % wt. gain)**—0.45% per ASTM D570

**Flammability Rating**—UL94V-1

**Chemical Resistance**—Resistant to acids, alkalies, and aliphatic hydrocarbons and ketones, per ASTM D543

**Radiation Resistance (ergs g-1 (C))**—2.7 x 108

**UL Independent Testing Service Recognitions:**

**Wire Sizes**—Solid or Stranded, Tubular Screw Cat. # 362-BU, 0362

1 #4 AWG, 1 #6 AWG, 1 #8 AWG,  
1 to 4 #10 AWG, 1 to 5 #12 AWG, 1 to 6 #14 AWG, 1 to 6 #16 AWG, 1 to 8 #18 AWG

**Related Product Data**

**Wire Pins and Ferrules**—Pages 135-137

For more information on AMP Standard Terminals and Splices or Quick-Connect FASTON Receptacles and Tabs, request Catalog 82042.

Cat #'s  
31 and  
32



E63810

**Note:** All part numbers are RoHS Compliant.

**300 Series, Fuse & Switch, Phenolic, Flat Base**

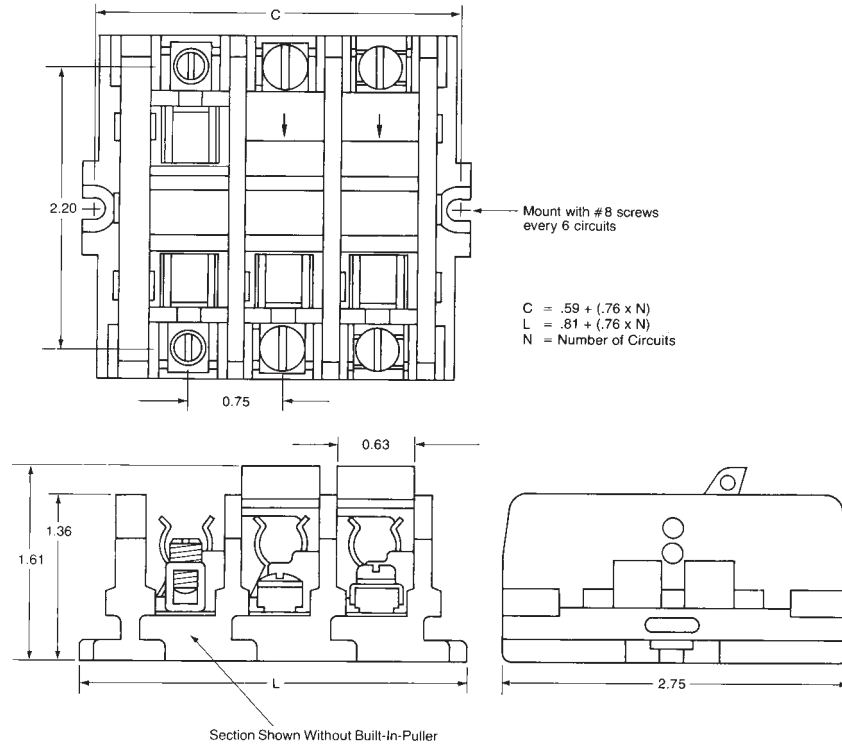

**Dovetail Base Mounted On Standard #60 Channel**

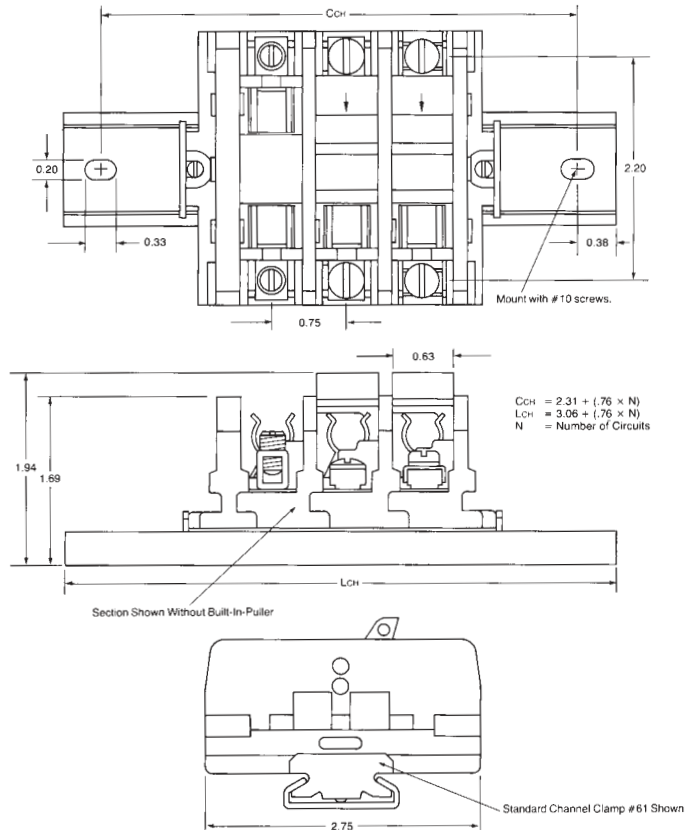

## One-Piece Phenolic Blocks

### Product Facts

- n Two, four, six, eight, and twelve circuit models available — 5/8" [15.88] center-to-center contact spacing.
- n No assembly required — each is a single, easily installed unit.
- n Three contact styles available — strap screw, captive strap clamp, and moving tubular contact.
- n Use wire up to #6 AWG with tubular contact. Strap screw and strap clamp contacts are available for #8 and smaller.
- n Withstand voltages in excess of IEEE standards for 750 volts. Meet clearance and creepage spacings specified in UL, CSA, and NEMA Industrial Control Standards for 600 Volts.
- n Strap contacts rated at 50 amperes — tubular contact conservatively rated at 70 amperes.
- n Pilot point screws supplied with strap screw and clamp contacts — speeds installation time.
- n Plain white marking strip supplied with each block — circuits are easily identified.
- n Special purpose blocks available—choose from blocks with solder posts, printed circuit board pins, or nuts on screw posts, removable circuit links, and a shorting bar.

Traditionally, these rugged One-Piece Blocks are the standard means of connection for heavy industrial applications like rail transport, utility, and traffic control industries. Ideal for dirty and vibration prone environments.

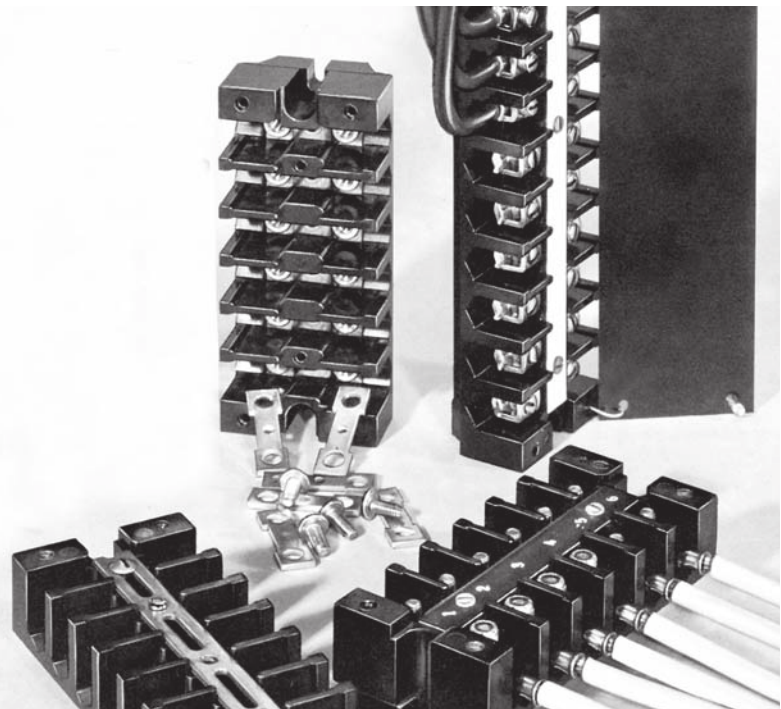

**B100, #B100 Series, One-Piece Blocks, 600 V — Phenolic**

**Material & Finish**

**Housing Material**—Phenolic, filled flame retardant

**Flammability**—UL94V-1

**Color**—Black

**Contacts**

**Standard Material**—Electrical grade copper or copper alloy conductor. Steel screws plated to resist corrosion in most industrial applications.

**Brass Material**—For Corrosive Environment (2B100, 4B100 Series) Nickel plated brass straps and screws. Meets specification QQ-N-290A Class 1, Grade G

**Wire Range**—Strap Screw: #18-8 AWG solid or stranded; Tubular Clamp: #14-6 AWG solid or stranded

**Screw Type**—Strap Screw: #10-32 Binding Head; Tubular Clamp: #1/4" [6.35]-28 Set Screw

**Strap Screw**—7/16" [11.11] max. lug width

**Mechanical Properties**

**Pitch (terminal spacing)**— .63" [16.00]

**Wire Strip Length**—Strap Screw: as needed for lugging; Tubular Clamp: 1/2" [12.1]

**Electrical Properties**

**Maximum Current**—70A for a single #6 AWG wire

**Operating Voltage**—Blocks meet 600V creepage and clearance requirements for general industrial control equipment and panelboards; greatly exceeds IEEE switchgear standards for 750 volts.

**Dielectric Strength (RH 40% @ sea level)**—300 Volts/mil thickness per ASTM D149

**UL High Voltage Arc Tracking (in./min.)**—.49-.58 [12.45-14.73]

**Environmental Properties**

**Max. Continuous Temperature**—150°C (302°F)

**Water Absorption (24hrs. % wt. gain)**—.45% per ASTM D570

**Chemical Resistance**—Resistant to acids, alkalis, and aliphatic hydrocarbons and ketones per ASTM D543



**Radiation Resistance (ergs G<sup>-1</sup> (C))**—2.7 x 10<sup>8</sup> min

**UL Independent Testing Service Recognitions**

**Wire Sizes**—Solid or Stranded, Tubular Clamp

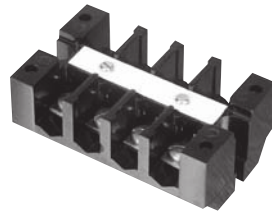
1—#6 AWG, 1—#8 AWG, 1or 2—#10 AWG, 1or 2—#12 AWG, 1 to 3—#14 AWG, 1—#10 & 1—#12 AWG  
1—#12 & 1—#14 AWG



| Circuits            | Steel Screw w/Strap   |                | Tubular Clamp   |                | Brass Screw w/Strap   |                |
|---------------------|---|----------------|---|----------------|---|----------------|
|                     | Part Number   | Catalog Number | Part Number   | Catalog Number | Part Number   | Catalog Number |
| <b>Contact Type</b> |   |                |   |                |   |                |
|                     |  |                |  |                |  |                |
| <b>AMPACITY</b>     |   |                |   |                |   |                |
|                     | 50A   |                | 65A   |                | 50A   |                |
| <b>Standard</b>     |   |                |   |                |   |                |
| 2                   | 2-1437382-6   | B102           | 2-1437382-8   | B102S          | 2-1437381-0   | 2B102          |
| 4                   | 3-1437382-0   | B104           | 3-1437382-6   | B104S          | 2-1437381-2   | 2B104          |
| 6                   | 4-1437382-0   | B106-BU        | 4-1437382-5   | B106S          | 2-1437381-6   | 2B106          |
| 8                   | 4-1437382-9   | B108           | 5-1437382-5   | B108S          | 3-1437381-0   | 2B108          |
| 12                  | 5-1437382-9   | B112-BU        | 6-1437382-7   | B112S          | 3-1437381-3   | 2B112          |
| <b>Shorting*</b>    |   |                |   |                |   |                |
| 2                   | 4-1437381-0   | 3B102P         | —   | —              | 5-1437381-6   | 4B102P         |
| 4                   | 4-1437381-1   | 3B104P         | —   | —              | 5-1437381-7   | 4B104P         |
| 6                   | 4-1437381-3   | 3B106P         | —   | —              | 5-1437381-8   | 4B106P         |
| 8                   | 4-1437381-5   | 3B108P         | —   | —              | 5-1437381-9   | 4B108P         |
| 12                  | 4-1437381-7   | 3B112P         | —   | —              | 6-1437381-0   | 4B112P         |

| Circuits              | Strap Screw #8 & Smaller |       | Threaded Post & Nut |       |
|-----------------------|--------------------------|-------|---------------------|-------|
| <b>Removable Link</b> |                          |       |                     |       |
| 2                     | 8-1437381-4              | 5B102 | —                   | —     |
| 4                     | 8-1437381-5              | 5B104 | —                   | —     |
| 6                     | 8-1437381-7              | 5B106 | —                   | —     |
| 8                     | 8-1437381-8              | 5B108 | —                   | —     |
| 12                    | 9-1437381-0              | 5B112 | —                   | —     |
| <b>Stud, #10-32</b>   |                          |       |                     |       |
| 2                     | —                        | —     | 1-1437382-8         | 7B102 |
| 4                     | —                        | —     | 2-1437382-0         | 7B104 |
| 6                     | —                        | —     | 2-1437382-1         | 7B106 |
| 8                     | —                        | —     | 2-1437382-2         | 7B108 |
| 12                    | —                        | —     | 2-1437382-3         | 7B112 |

**Notes:**

For prenumbered marking strip, add suffix "N" to Catalog Number. Cannot be used on 3B or 4B series.

For factory assembled hinged cover, add suffix "H" to Catalog Number. Cannot be used on 3B or 4B series.

For factory assembled thumbscrew-fastened cover, add suffix "T" to Catalog Number. Cannot be used on 3B or 4B series.

Screws and removable links shipped unassembled.

\*Shorting blocks are supplied with 2 shorting screws each.

Except for 3B and 4B Series



**Note:** All part numbers are RoHS Compliant.

**B100, #B100 Series, One-Piece Blocks, 600 V — Phenolic Accessories**

**Covers and Marking**



| Circuits | Laminated Phenolic Cover |                | Shorting Block Cover |                | White Marking Strip |                | Numbered Marking Strip |                |
|----------|--------------------------|----------------|----------------------|----------------|---------------------|----------------|------------------------|----------------|
|          | Part Number              | Catalog Number | Part Number          | Catalog Number | Part Number         | Catalog Number | Part Number            | Catalog Number |
| 2        | 7-1437382-5              | C102-BU        | 9-1437382-2          | CS102          | 1-1437383-5         | S102           | 1776733-2              | N102           |
| 4        | 7-1437382-6              | C104-BU        | 9-1437382-3          | CS104          | 1-1437383-6         | S104           | 1-1437383-1            | N104           |
| 6        | 7-1437382-7              | C106-BU        | 9-1437382-4          | CS106          | 1-1437383-7         | S106           | 1-1437383-2            | N106           |
| 8        | 7-1437382-8              | C108-BU        | 9-1437382-5          | CS108          | 1-1437383-8         | S108           | 1-1437383-3            | N108           |
| 12       | 7-1437382-9              | C112-BU        | 9-1437382-6          | CS112          | 1-1437383-9         | S112           | 1-1437383-4            | N112           |

**Jumpers**



**Hardware**



| Circuits        | 30A Copper Jumpers |             | 50A 12 Circuit Jumpers |             | Connecting Link |             | Lock Nuts |             | Shorting Screw |             |
|-----------------|--------------------|-------------|------------------------|-------------|-----------------|-------------|-----------|-------------|----------------|-------------|
|                 | Part No.           | Catalog No. | Part No.               | Catalog No. | Part No.        | Catalog No. | Part No.  | Catalog No. | Part No.       | Catalog No. |
| 2               | 1437383-2          | J102        | —                      | —           | —               | —           | —         | —           | —              | —           |
| 4               | 1437383-3          | J104        | —                      | —           | —               | —           | —         | —           | —              | —           |
| 6               | 1437383-4          | J106        | —                      | —           | —               | —           | —         | —           | —              | —           |
| 8               | 1437383-5          | J108        | —                      | —           | —               | —           | —         | —           | —              | —           |
| 12              | 1437383-6          | J112        | 1437395-9              | HJ112       | —               | —           | —         | —           | —              | —           |
| <b>Hardware</b> |                    |             |                        |             |                 |             |           |             |                |             |
| —               | —                  | —           | —                      | —           | 9-1437382-0     | CL101       | 1437383-7 | LN101-BU    | 7-1437381-7    | 51-BU       |

**Related Product Data**

**Wire Pins and Ferrules**—Pages 109-111  
 For more information on AMP Standard Terminals and Splices or Quick-Connect FASTON Receptacles and Tabs, request Catalog 82042.



**Note:** All part numbers are RoHS Compliant.

**B100, #B100 Series, One-Piece Blocks, 600 V — Phenolic**

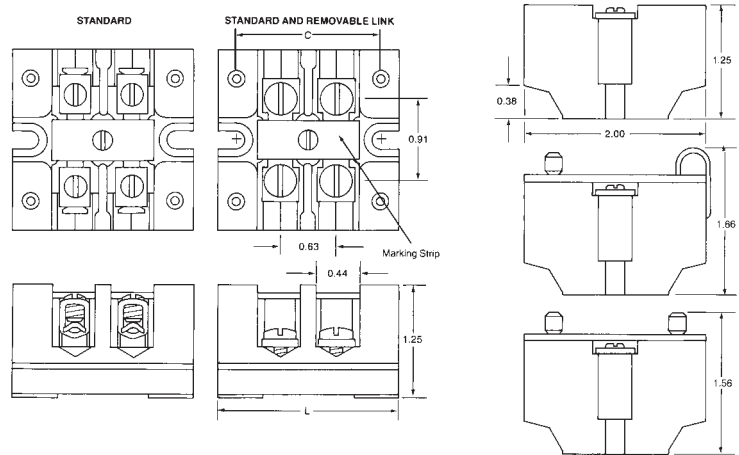

| No. of Ckts. | C    | L    |
|--------------|------|------|
| 2            | 1.63 | 2.00 |
| 4            | 2.88 | 3.25 |
| 6            | 4.13 | 4.50 |
| 8            | 5.38 | 5.75 |
| 12           | 7.88 | 8.25 |

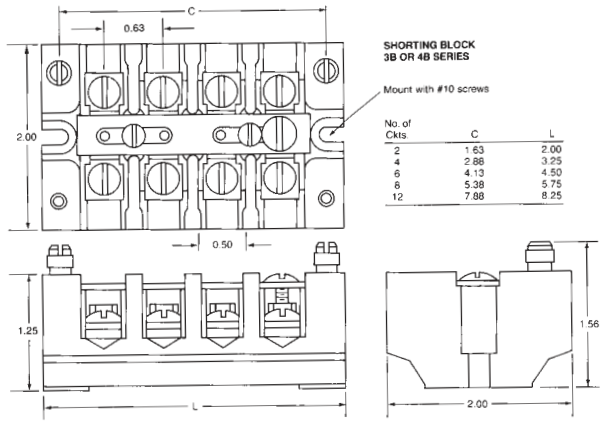

| No. of Ckts. | C    | L    |
|--------------|------|------|
| 2            | 1.63 | 2.00 |
| 4            | 2.88 | 3.25 |
| 6            | 4.13 | 4.50 |
| 8            | 5.38 | 5.75 |
| 12           | 7.88 | 8.25 |

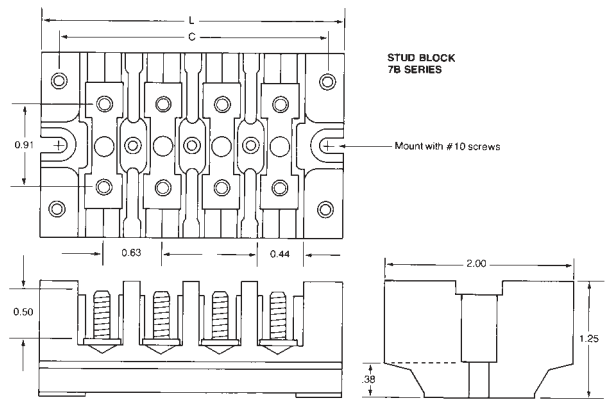

**Note:** All part numbers are RoHS Compliant.

## Pre-Printed Marking Strips

Circuit identification is greatly simplified with the use of pre-printed strips for BUCHANAN terminal blocks. These hot-stamped strips are available for all snap-assembled sections (except Fuse, Switch, and Circuit Breaker models which are marked individually). The strips can be ordered separately or pre-installed on factory assembled sectional block units.

Unlike painted or screened letters, hot-stamped letters are designed to not rub or flake off during industrial use so that they will retain their legibility.

Marking strips are stamped with consecutive numbers that can be ordered to read from left-to-right or right-to-left, and in vertical or horizontal positions. Number sequences can begin with any number. This allows circuits to be identified in a manner most consistent with the terminal block application.

**M 50 005 13 G**

**A B C D E**

- A M = Hot-Stamped Marking Strip**
- B Terminal Block Series and Designator**  
 10 = Miniature or Single Tier  
 12 = Double Tier  
 67 = 900 Series Medium Duty  
 24 = Nylon Heavy Duty  
 21 = Phenolic Heavy Duty  
 80 = Intermediate Heavy Duty  
 40 = Ultra Heavy Duty  
 T2 = TSB230  
 T5 = TSB500  
 T6 = TSB1000  
 T7 = TSB2000
- C Number of Circuits to be Consecutively Numbered**  
 (Use three digits: Ex.: 005 = 5, 055 = 55, etc.)
- D Marking Style Options**  
 11 = 1 2 3 4 5...  
 12 = ...5 4 3 2 1  
 13 = ... 1 2 3 4 5...  
 14 = ... 5 4 3 2 1
- E "First Number In Series" Designator\***  

|       |       |
|-------|-------|
| A = 1 | F = 6 |
| B = 2 | G = 7 |
| C = 3 | H = 8 |
| D = 4 | J = 9 |
| E = 5 | K = 0 |

### Marking Strip Installed On A Factory-Assembled Terminal Block

**615 005 11 A**

**A B C D**

- A Basic Sectional Block Catalog #**
- B Number of Circuits to be Factory Assembled and Consecutively Numbered**  
 (Use three digits: Ex: 005 = 5, 055 = 55, etc.)
- C Marking Style Options**  
 11 = 1 2 3 4 5...  
 12 = ...5 4 3 2 1  
 13 = ... 1 2 3 4 5...  
 14 = ... 5 4 3 2 1
- D "First Number In Series" Designator\***  

|       |       |
|-------|-------|
| A = 1 | F = 6 |
| B = 2 | G = 7 |
| C = 3 | H = 8 |
| D = 4 | J = 9 |
| E = 5 | K = 0 |

\* Letters in this position designate the first number to be used in the consecutive sequence. Ex.: "A" would start the sequence with the number 1. "EK" would start the sequence with the number 50. "BKK" would start the series with 200. For non-sequential numbering and special characters, consult Technical Support.

**Note:** All part numbers are RoHS Compliant.

## Technical Summary

| Cat. No.                | Terminal Block or Product Line | Contact Type Material Plate                   | Screw                            |  | Material & Plating  | Recommended Screwdriver Dimensions |              | Wire Strip Length     | Wire Range AWG | Rec. Torque in. - lb. |
|-------------------------|--------------------------------|---|----------------------------------|--|---------------------|------------------------------------|--------------|-----------------------|----------------|-----------------------|
|                         |                                |   | Screw Style                      | Slot Size                                  |                     | Tip Thick                          | Tip Width    |                       |                |                       |
| 105-BU<br>115<br>125-BU | High Density Tubular Clamp     | Electroplated Tubular Copper Contact          | 6-32 Slotted Screw               | 033" Wide x .040" Deep [1.84 x 1.02] Steel | Steel Electroplated | .020" [.51]                        | 9/64" [6.02] | 5/16" [7.94]          | #12-30         | 10                    |
| 211<br>241              | HeavyDuty Strap Screw          | Copper Alloy Strap Electroplated              | Binding Head 10-32 Thread        | 062" Wide x 062" Deep [1.57 x 1.57]        | "                   | .037" [.94]                        | 1/4" [6.35]  | As Needed for Lugging | #8 or Smaller  | 12                    |
| 212<br>222-BU<br>242    | Heavy Duty Tubular Screw       | Electroplated Tubular Copper Contact          | Headless 1/4"-28 Thd. Slotted    | 3/64" Wide x 1/16" Deep [1.19 x 1.59]      | "                   | "                                  | "            | 1/2" [12.7]           | #4-18          | 35                    |
| 213<br>243              | Heavy Duty Tubular Clamp       | "   | "                                | "  | "                   | "                                  | "            | "                     | #6-18          | 35                    |
| 218<br>248              | Heavy Duty Strap Clamp         | Copper Alloy Strap Electroplated              | Pan Head Saddle Clamp 8-32 Thd.  | 3/64" Wide x 3/64" Deep [1.19 x 1.19]      | "                   | "                                  | "            | "                     | #8-18          | 12                    |
| 351<br>361<br>0311      | Fuse Block Strap Screw         | Copper Alloy Electroplated Spring Temper      | Binding Head 8-32 Thd.           | "  | "                   | "                                  | "            | As Needed for Lugging | #8 or Smaller  | 10                    |
| 358<br>368<br>318       | Fuse Block Strap Clamp         | "   | Pan Head w/SaddleClp. 8-32 Thd.  | "  | "                   | "                                  | "            | 1/2" [12.7]           | #8-18          | "                     |
| 352<br>362-BU<br>312    | Fuse Block Tubular Screw       | Same as above except use H.D. Tubular Contact | Headless 1/4"-28 Thd. slotted    | "  | "                   | "                                  | "            | "                     | "              | "                     |
| 341<br>371<br>342       | Switch Block Strap Screw       | CopperAlloy Electroplated Spring Temper       | "                                | "  | "                   | "                                  | "            | As Needed for Lugging | #8 or Smaller  | "                     |
| 348<br>0378             | Switch Block Strap Clamp       | "   | Pan Head w/SaddleClp 8-32 Thd.   | "  | "                   | "                                  | "            | 1/2" [12.7]           | #8-18          | "                     |
| 342<br>0372             | Switch Block Tubular Screw     | Same as above except use H D. Tubular Contact | "                                | "  | "                   | "                                  | "            | "                     | "              | "                     |
| 416<br>426-BU           | Extra Heavy Duty Tubular Screw | Electroplated-Tubular Copper Contact          | 1/2"-13 Hex Socket Hd. Set Screw | 1/4" [6.35] Hex                            | "                   | 1/2" [12.7] Hex                    | T-Bar Key    | 7/8" [22.23]          | #12-2/0        | 200                   |

**Note:** Representative Catalog Numbers Listed.



### Technical Summary (Continued)

| Cat. No.          | Terminal Block or Product Line | Contact Type Material plate   | Screw                             |                                       | Material & Plating  | Recommended Screwdriver Dimensions |              | Wire Strip Length     | Wire Range AWG | Rec. Torque in. - lb. |
|-------------------|--------------------------------|---|-----------------------------------|---------------------------------------|---------------------|------------------------------------|--------------|-----------------------|----------------|-----------------------|
|                   |                                |   | Screw Style                       | Slot Size                             |                     | Tip Thick                          | Tip Width    |                       |                |                       |
| 417               | Extra HD                       | Electroplated   | 3/4"-16 Hex Socket Head Set Screw | 3/8" Hex [9.53]                       | Steel Electroplated | 3/8" Hex [9.53]                    | KeyT-Bar     | 1" [25.4]             | #6-250         | 375 kcmil (MCM)       |
| 427-BU            | Tubular Screw                  | Tubular Copper Contact  |                                   |                                       |                     |                                    |              |                       |                |                       |
| 517<br>617<br>717 | Medium Duty Quick-Connect      | 1/4" Wide QC .032" Thk Copper Alloy Electroplated                       | N/A                               | N/A                                   | N/A                 | N/A                                | N/A          | N/A                   | N/A            | N/A                   |
| 1546235-1         | Medium Duty Tubular Clamp      | Electroplated Tubular Copper Contact                                    | 10-32 Slotted Hd                  | .046" Wide x .046" Deep [1.17 x 1.17] | Steel Electroplated | .032" [.81]                        | 3/16" [4.76] | 11/32" [8.73]         | #10-22         | 8                     |
| 1546152-1         | Medium Duty QC & Tubular Screw | 1/4" Wide QC .032" Thk. Tubular Contact Both Copper Alloy Electroplated | "                                 | "                                     | "                   | "                                  | "            | "                     | #8-18          | 10                    |
| 1546148-1         | Medium Duty Tubular Screw      | Electroplated Tubular Copper Contact                                    | "                                 | "                                     | "                   | "                                  | "            | "                     |                | 8                     |
| 1546143-1         | Medium Duty Strap Screw        | Copper Alloy Strap Electroplated  | 6-32 Thd. Slotted Binding Hd.     | 3/64" Wide x 3/64" Deep [1.19 x 1.19] | "                   | "                                  | "            | As Needed for Lugging | #8 or Smaller  | 12                    |
| 824-BU            | Intermediate Tubular Screw     | Electroplated Tubular Copper Contact                                    | 7/16"-20Thd. Slotted Headless     | 5/64" Wide x 5/64" Deep [1.98 x 1.98] | "                   | .041" [1.04]                       | 3/8" [9.53]  | 11/16" [17.46]        | #12-1/0        | 50                    |
| B102<br>B112-BU   | One-Piece Blk. Strap Screw     | Copper Alloy Strap Electroplated  | 10-32 Thd. Slotted Binding Hd.    | 1/16" Wide x 1/16" Deep [1.59 x 1.59] | "                   | .037" [.94]                        | 1/4" [6.35]  | As Needed for Lugging | #8 or Smaller  | 20                    |
| B102S<br>B112S    | One-Piece Blk. Tubular Contact | Tubular Contact   | 1/4" -28 Thd. Headless Set Screw  | 3/64" Wide x 3/64" Deep [1.19 x 1.19] | "                   | "                                  | "            | 1/2" [12.7]           | #6-14          | 45                    |

**Note:** Representative Catalog Numbers Listed.

## UL 1059 Basic Voltage Rating

Voltage ratings of terminal blocks are based on the minimum spacing between electrical conductive parts of opposite polarity or between an electrically conductive part and a metal mounting surface measured under two conditions: Through Air, defined as the distance an arc must take through the air to go from one live conductor to another or from a live conductor to ground; and Over Surface, defined as the distance an arc must take over a surface of the insulating material going from one terminal to ground, assuming the arc will travel along the surface rather than through the air. The following chart shows UL 1059 spacing requirements in inches.

### Voltage Rating

| Description   | Voltage                            | Spacing Requirements                     |  |
|---|------------------------------------|--|--|
|   |                                    | Thru Air                                 | Over Surface                             |
| Class A<br>Service equipment including deadfront switchboards, panel boards, service entrance devices, etc.             | 51 - 150<br>151 - 300<br>251 - 600 | 1/2 [12.7]<br>3/4 [19.05]<br>1 [25.4]    | 3/4 [19.05]<br>1 1/4 [31.75]<br>2 [50.8] |
| Class B<br>Commercial appliances including business equipment, electronic data processing equipment and the like        | 51 - 150<br>151 - 300<br>251 - 600 | 1/16 [1.59]<br>3/32 [2.38]<br>3/8 [9.53] | 1/16 [1.59]<br>3/32 [2.38]<br>1/2 [12.7] |
| Class C<br>General industrial and machine tools; controls which can be further defined as equipment falling under UL508 | 51 - 150<br>151 - 300<br>301 - 600 | 1/8 [3.18]<br>1/4 [6.35]<br>3/8 [9.53]   | 1/4 [6.35]<br>3/8 [9.53]<br>1/2 [12.7]   |
| Devices having limited ratings <sup>a</sup>   | 51 - 300<br>301 - 600              | 1/16 [1.59]<br>3/16 [4.76]               | 1/8 [3.18]<br>3/8 [9.53]                 |

<sup>a</sup>Load on any single circuit can not exceed 15 A at 51-150 V, 10 A at 151-300 V, 5 A at 301-600 V or the maximum current rating, whichever is less.

### Standard Test Criteria

| Test                  | Per:               |
|-----------------------|--------------------|
| Heat Cycling (term)   | UL486E Section 10  |
| Static Heating (term) | UL486E Section 11  |
| Secureness            | UL486E Section 12  |
| Pullout               | UL486E Section 14  |
| Heating Test (block)  | UL1059 Section 10  |
| Dielectric Withstand  | UL1059 Section 11  |
| Strength of Base      | UL1059 Section 13  |
| Tab Pull              | UL1059 Section 14  |
| VPTA                  | UL1059 Section 15  |
| Salt Spray            | MIL-202 Method 101 |
| Solderability         | MIL-202 Method 208 |
| Solvents              | MIL-202 Method 215 |