

LUMAWISE ENDURANCE S Z10 ENABLED CONNECTOR SYSTEM

TE Connectivity (TE)'s LUMAWISE Endurance S Z10 (0-10V Enabled) Key A Connector System expands the ecosystem of products designed for sensor and other control system applications. The keyed version provides 0-10V mating combinations that bring flexibility and differentiation to the designer.

The Endurance S product portfolio includes a keyed receptacle connector as well as a mating keyed 40mm and 80mm diameter base and various domes. The bases and domes combine to create enclosures that accept electronics for sensing and control in harsh outdoor environments and indoor applications that include motion, occupancy and day light harvesting. The compact, UV resistant, IP66 seal rated design can be mounted upwards, downwards or sideways on a lighting fixture offering flexibility in design use while providing a sealed electrical interface and robust packaging solution. Keyed mating combinations bring additional flexibility to the designer and differentiation between applications in the field.

FEATURES:

- Compact size allowing greater flexibility in luminaire design
- IP66 sealing with no mounting screws
- Simple insert and rotate to lock feature, no tooling needed and one handed operation to install allows luminaires to be simply and quickly upgraded
- High impact protection - IK09 rating
- Flexible mounting position. Top mounted, side mounted and bottom mounted facing
- Scalable solution allows use of Ø40mm or Ø80mm controls with the same connection interface
- Poke-in contact design for easy and reliable wire termination
- CB certification

APPLICATIONS:

- Street and area lighting
- Roadway lighting
- Commercial / municipal outdoor lighting
- Outdoor luminaires
 - Wall packs
 - Parking lots
 - Walkways photo controls
- Indoor Luminaires
 - 2 X 2 and 2 X 4 troffers
 - Linear luminaires
 - High bay lights
 - Cove lighting
- City management system
- Sensor modules i.e. motion

ELECTRICAL:

- Contact rating: 5A, 250V
- Meets 10kV dielectric withstand voltage to mounting surface 4 pole contacts

MECHANICAL:

- Mounting: M20X1.5 thread
- Height above luminaire: 10mm
- IP65 & IP66
- Receptacle: Ø30mm
- Gasket: Ø36.5mm
- Thread length: 18.5mm
- IK09 rated system solution

MATERIALS:





- PBT receptacle
- LSR gasket
- Polycarbonate domes
- UL UV-f1 rated for outdoor use

SPECIFICATIONS:

- Product: [108-133073](#)
[108-160194](#)
- Application: [114-133074](#)
[114-160106](#)
- Rated IEC61984 and UL773
- CB Certified

Z10 ENABLED CONNECTOR SYSTEM



Product Selection Information



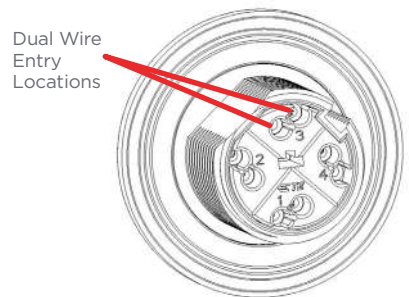

	Part Number	Description	Color	Key
RECEPTACLE / SEALING CAP	 2343403-1	S Receptacle (includes sealing ring, washer & nut)	Black	A
	 2363638-2	S2 Receptacle (dual wire poke-in includes sealing ring, washer & nut)	Black	A
	 1-2363638-2	S2 Receptacle w/color code (dual wire poke-in includes sealing ring, washer & nut)	Black	A
	 2341474-1 2341474-2 2341474-3	Sealing Cap	Dark Gray Light Gray White	A

FEATURES (S2 Receptacle PN 2363638)

- Receptacle connector with double poke-in wire entry
- Strong wire-trap poke-in retention
- Wire release feature
- Light colored wire entry surface
- Directional washer
- Compression stop on sealing gasket



	Part Number	Description	Key
40mm / 80mm BASES	 2343405-1	40mm Base	A
	 2-2343404-1	80mm Base	A
	 1-2343404-1	80mm Base with vent	A

	Part Number	Description	Color	Height
40mm DOMES	 1-2329013-1	40mm Dome	Clear	Low (24.25mm)
	 1-2329013-2	40mm Dome	Clear	Tall (39.25mm)
80mm DOMES	 1-2328823-1	80mm Dome	Clear	Low (33.43mm)
	 1-2328823-2	80mm Dome	Clear	Medium (43.43mm)
	 1-2328823-3	80mm Dome	Clear	Tall (58.43 mm)

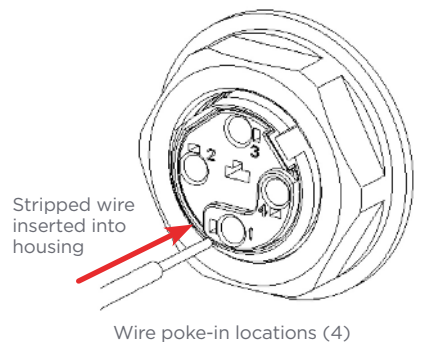

RECOMMENDED PIN OUT FOR 0-10V DIMMING CONTROL APPLICATION

Pin #	Function
1	DC+
2	0-10V DIM-DC
3	0-10V DIM+
4	OPTIONAL

Colored wire insertion markings and additional keying solutions are also available, contact [Product and Customer Support](#).

Z10 ENABLED CONNECTOR SYSTEM

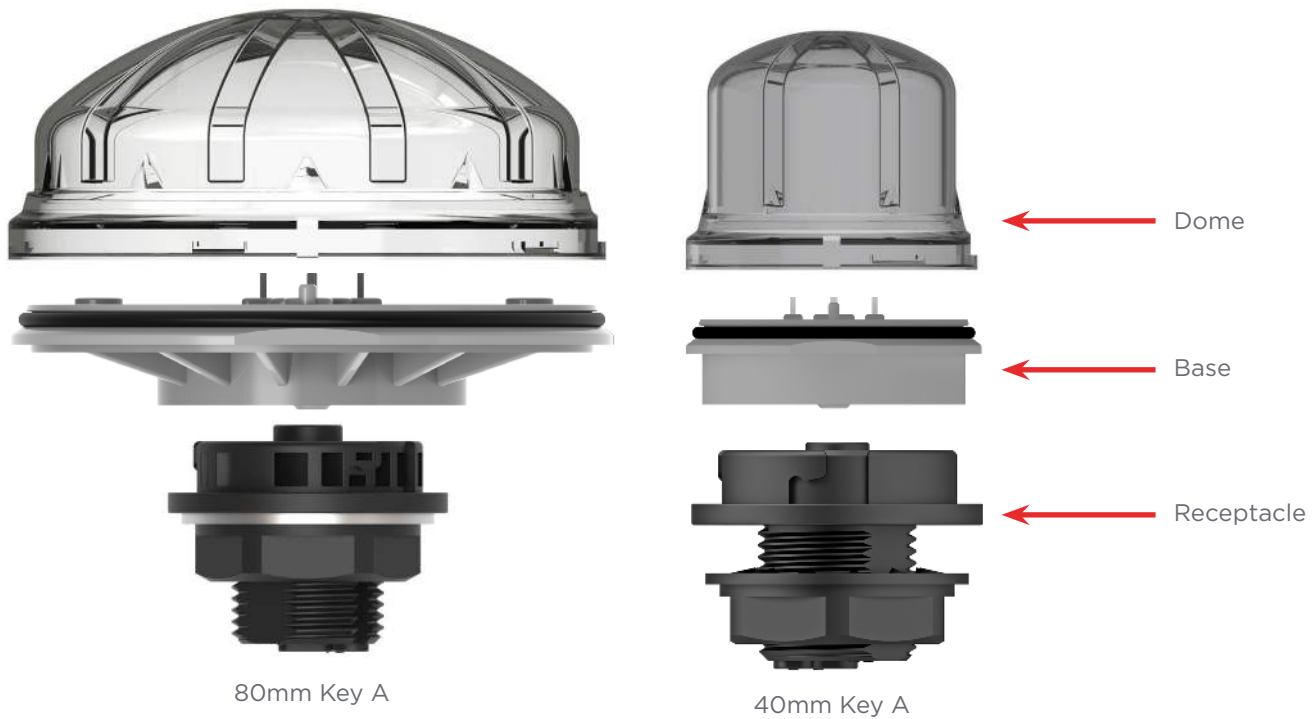

1-2343404-1

LUMAWISE Endurance S Base with Vent
Key A 80mm

Flat surface for label placement.

An optional vent in the 80mm base assembly enables pressure optimization inside the sealed control module. The vent also helps to minimize condensation through vapor diffusion.

LUMAWISE Endurance S products represented on this page are shown actual size.

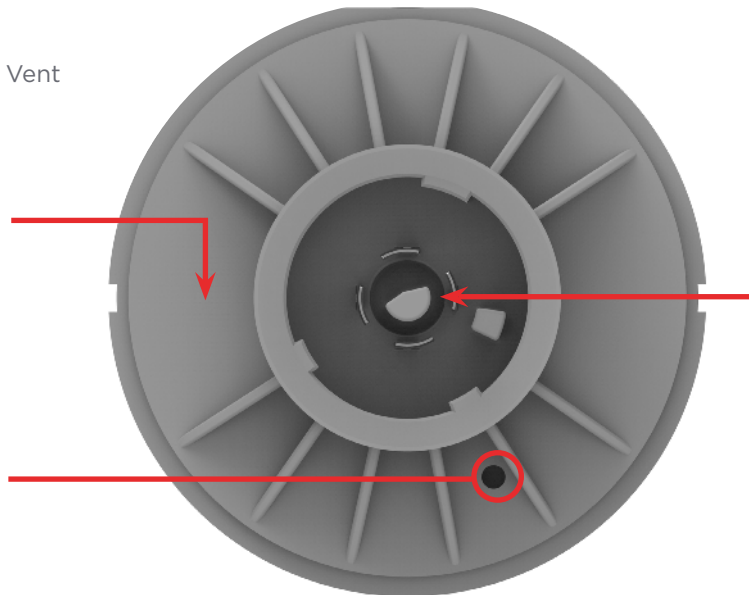

te.com

© 2021 TE Connectivity. All Rights Reserved.

LUMAWISE, TE Connectivity, TE connectivity (logo) and Every Connection Counts are trademarks. All other logos, products and/or company names referred to herein might be trademarks of their respective owners.

While TE has made every reasonable effort to ensure the accuracy of the information in this brochure, TE does not guarantee that it is error-free, nor does TE make any other representation, warranty or guarantee that the information is accurate, correct, reliable or current. TE reserves the right to make any adjustments to the information contained herein at any time without notice. TE expressly disclaims all implied warranties regarding the information contained herein, including, but not limited to, any implied warranties of merchantability or fitness for a particular purpose. The dimensions in this catalog are for reference purposes only and are subject to change without notice. Specifications are subject to change without notice. Consult TE for the latest dimensions and design specifications.