



The Future of Analog IC Technology®

EVM3833C-RH-00A

3A Synchronous Step-down Module Evaluation Board

DESCRIPTION

The MPM3833C is a monolithic step-down module converter with built-in power MOSFETs and inductor. The DC-DC module comes a small surface-mount QFN-18(2.5mm×3.5mm×1.6mm) package and achieves 3A continuous output current from 2.7V to 6V input voltage with excellent load and line regulation. The MPM3833C works into the forced continuous current mode, and has sub 10 mV voltage ripple with one output capacitor, making it suitable for optical module, FGPA, ASIC and other applications requiring low ripple noise. The output voltage is regulated as low as 0.6V. Only FB resistors and input and output capacitors are needed to complete the design.

The Constant-on-time control (COT) scheme provides fast transient response and easy loop stabilization.

Fault condition protection includes cycle-by-cycle current limit and thermal shutdown.

ELECTRICAL SPECIFICATION

Parameter	Symbol	Value	Units
Input Voltage	V _{IN}	2.7 – 6	V
Output Voltage	V _{OUT}	1.2	V
Output Current	I _{OUT}	3	A

Note: V_{IN}<3.3V may need more input capacitor.

FEATURES

- Wide 2.7V to 6V Operating Input Range
- Adjustable Output from 0.6V
- 2.5mm×3.5mm×1.6mm QFN-18 Package
- Low Radiated Emission(EMI) Complies with EN55022 Class B Standard
- Up to 3A Continuous Output Current
- 100% Duty Cycle In Dropout
- Forced Continuous Current Mode
- EN and Power Good for power Sequencing
- Cycle-by-Cycle Over-Current Protection
- Short Circuits Protection with Hiccup Mode
- Only Four External Components Needed

APPLICATIONS

- FPGA, ASIC, DSP Power
- Optical Modules
- LDO Replacement
- Power for Portable Products
- Space-Limited Applications

All MPS parts are lead-free, halogen free, and adhere to the RoHS directive. For MPS green status, please visit MPS website under Quality Assurance.

"MPS" and "The Future of Analog IC Technology" are Registered Trademarks of Monolithic Power Systems, Inc.

EVM3833C-RH-00AEVALUATION BOARD



Board Number	MPS IC Number
EVM3833C-RH-00A	MPM3833CGRH

Efficiency vs. Output Current

V_{IN}=5V

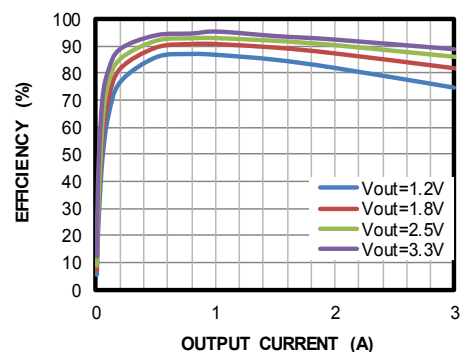

EVALUATION BOARD SCHEMATIC

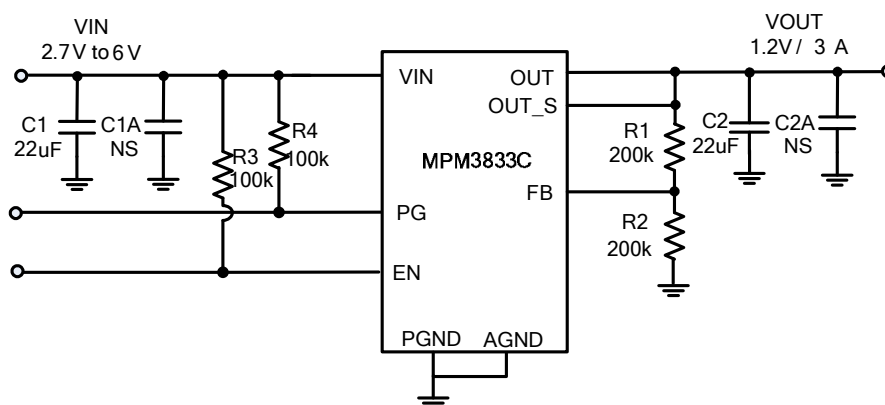

Figure 1—Typical Application Circuit for MPM3833CGRH

Note: $V_{IN} < 3.3V$ may need more input capacitor.

EVM3833C-RH-00ABILL OF MATERIALS

Qty	RefDes	Value	Description	Package	Manufacturer	Manufacturer/PN
2	C1,C2	22 μ F	Ceramic Cap.,16V,X7R	0805	TDK	C2012X7R1C226MT000N
0	C1A, C2A	NS				
2	R1,R2	200k	Film Res,1%,0603,200K	0603	YAGEO	RC0603FR-07200KL
2	R3,R4	100k	Film Res,1%,0603,100K	0603	YAGEO	RC0603FR-07100KL
1	U1	MPM3833 C	Synchronous Step-Down Converter	QFN-18	MPS	MPM3833CGRH

EVB TEST RESULTS

Performance waveforms are tested on the evaluation board.

$V_{IN} = 5V$, $V_{OUT} = 1.2V$, $C_{OUT} = 22\mu F$, $T_A = +25^\circ C$, unless otherwise noted.

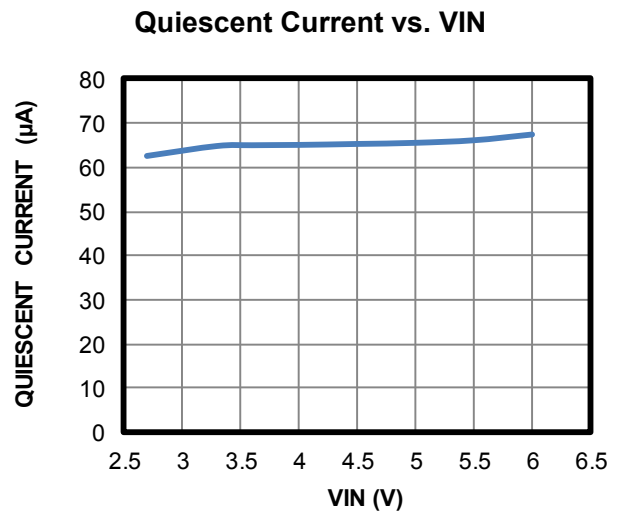
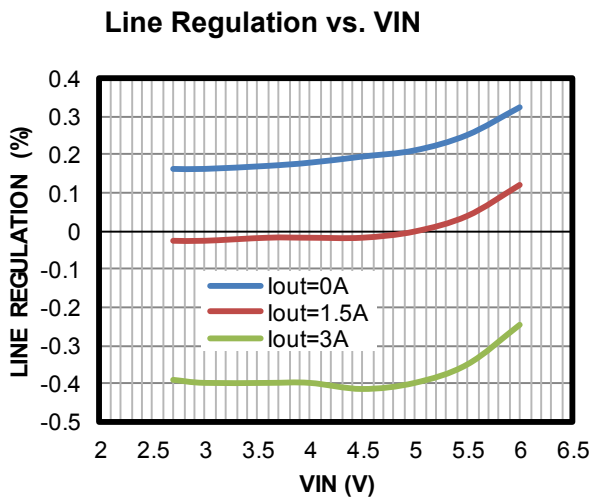
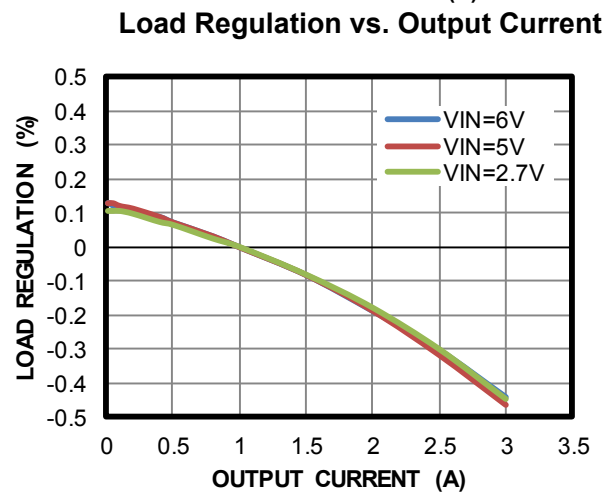
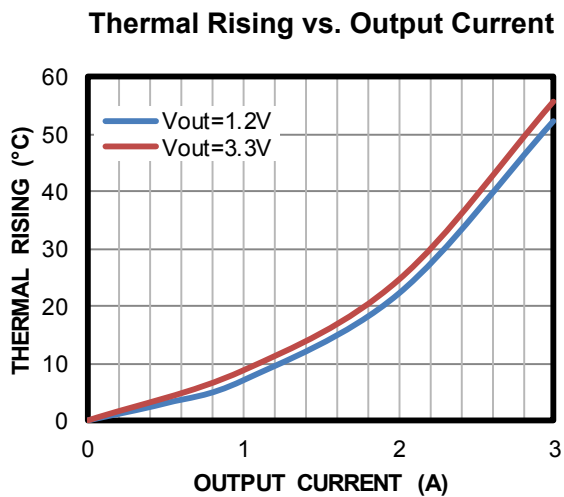
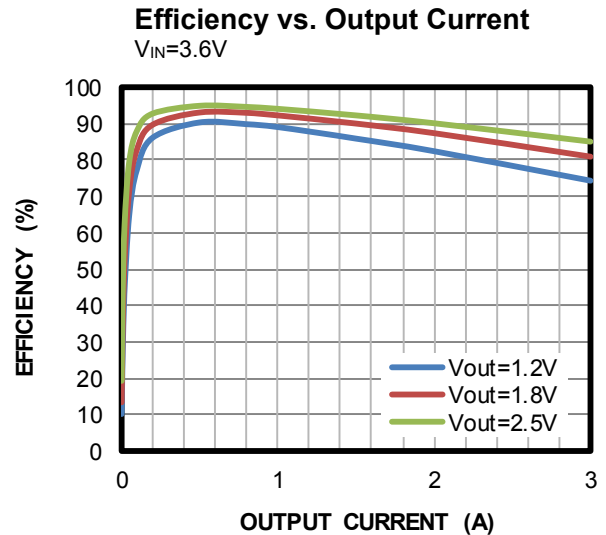
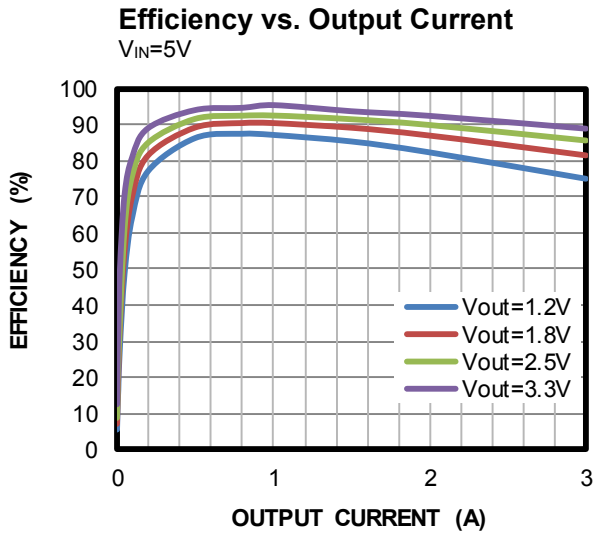

EVB TEST RESULTS *(continued)*

Performance waveforms are tested on the evaluation board.

$V_{IN} = 5V$, $V_{OUT} = 1.2V$, $C_{OUT} = 22\mu F$, $T_A = +25^\circ C$, unless otherwise noted.

Shutdown Current vs. VIN

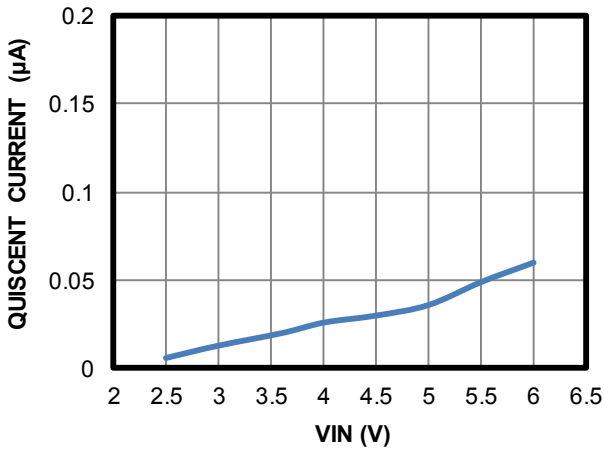

Output Current vs. Ambient Temperature
 $T_J < 125^\circ C$

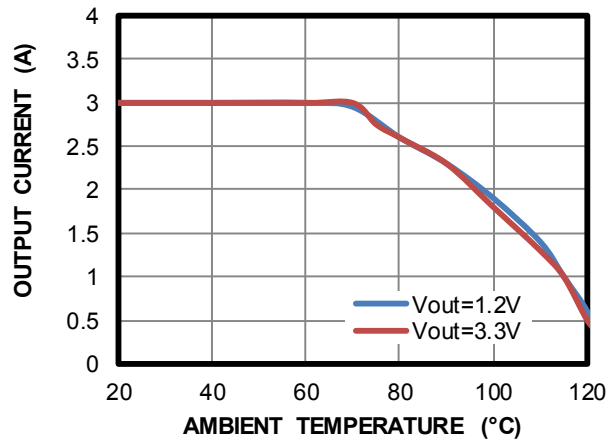

Power Good OV Threshold vs. Temperature

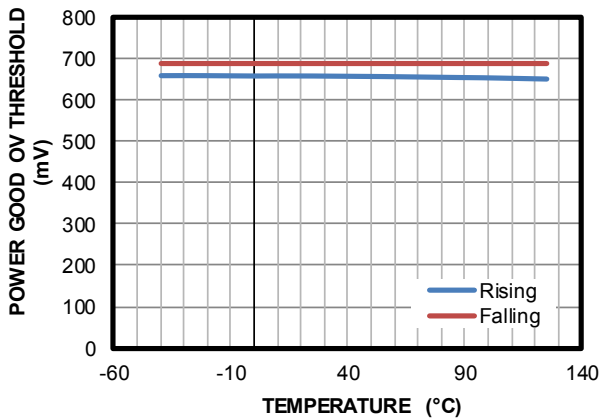

UVLO VIN Rising and Falling Threshold vs. Temperature

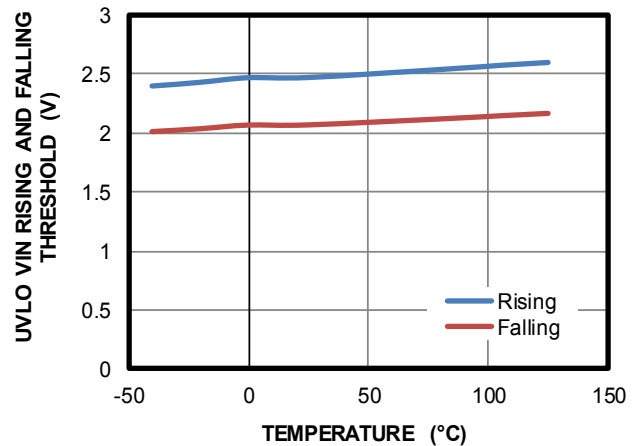

EN Rising and Falling Threshold vs. Temperature

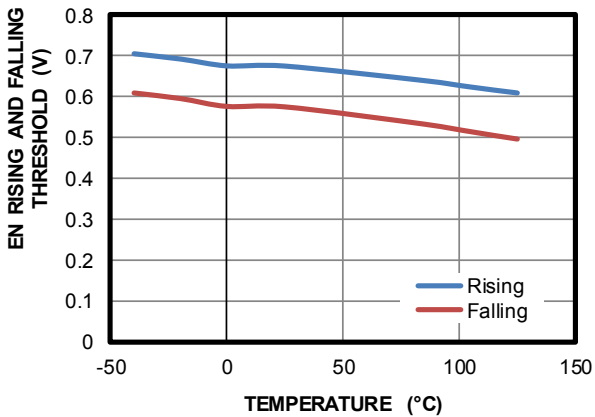

Power Good UV Threshold vs. Temperature

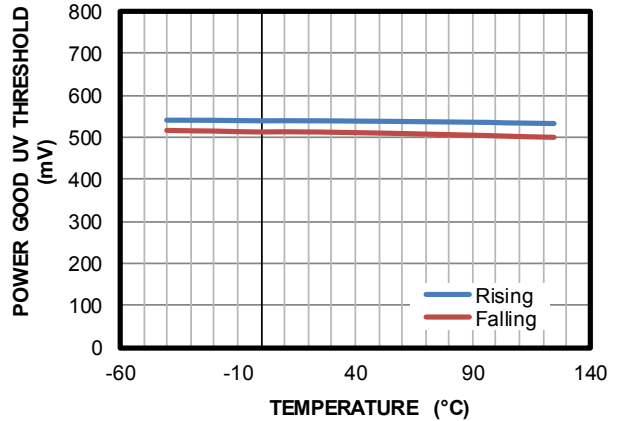

EVB TEST RESULTS *(continued)*

Performance waveforms are tested on the evaluation board.

$V_{IN} = 5V$, $V_{OUT} = 1.2V$, $C_{OUT} = 22\mu F$, $T_A = +25^\circ C$, unless otherwise noted.

Radiated Emission

$I_{OUT} = 3A$, Tested on EVM3833C-RH-00A

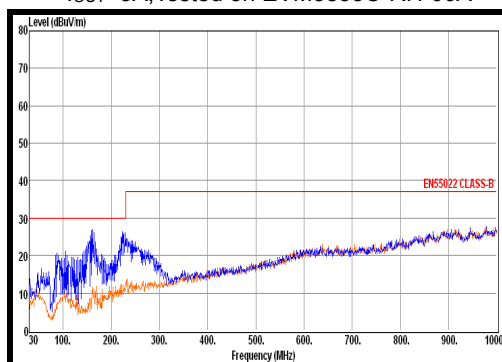

EVB TEST RESULTS (continued)

Performance waveforms are tested on the evaluation board.

$V_{IN} = 5V$, $V_{OUT} = 1.2V$, $C_{OUT} = 22\mu F$, $T_A = +25^\circ C$, unless otherwise noted.

Steady State

$I_{OUT} = 0A$

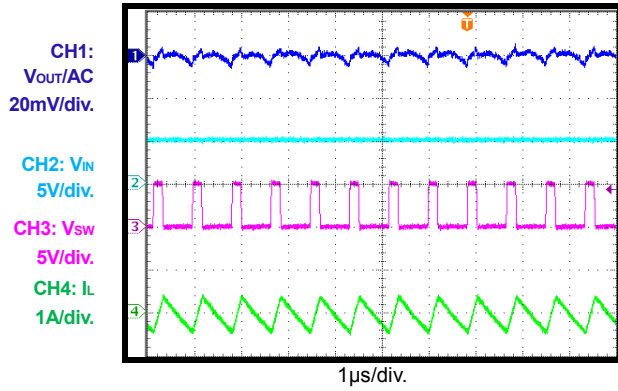

Steady State

$I_{OUT} = 3A$

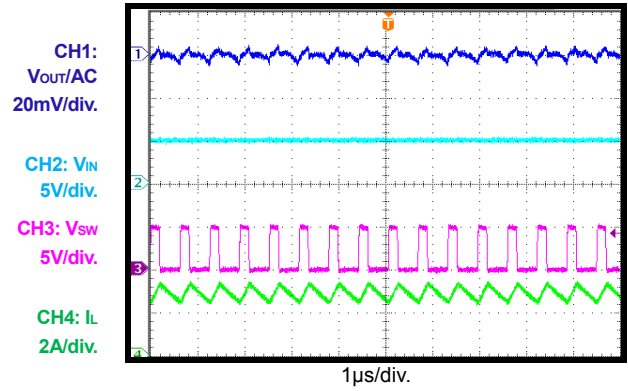

VIN Power-Up

$I_{OUT} = 0A$

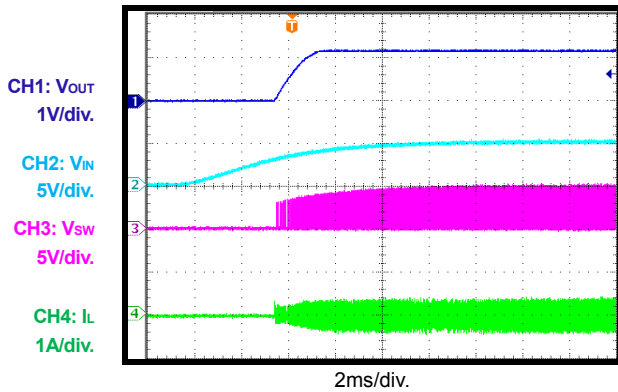

VIN Power-Up

$I_{OUT} = 3A$

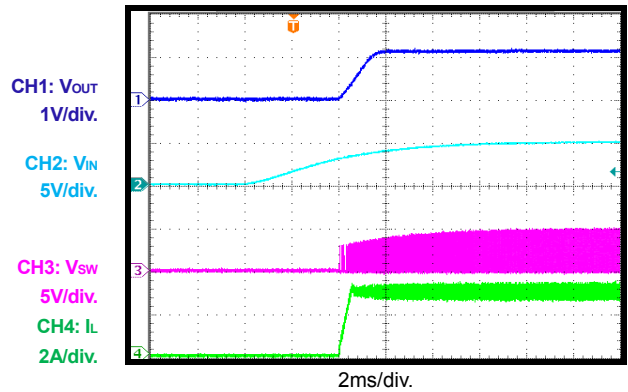

VIN Shutdown

$I_{OUT} = 0A$

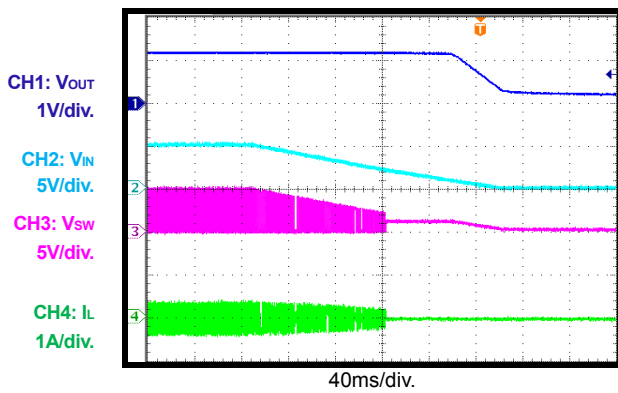

VIN Shutdown

$I_{OUT} = 3A$

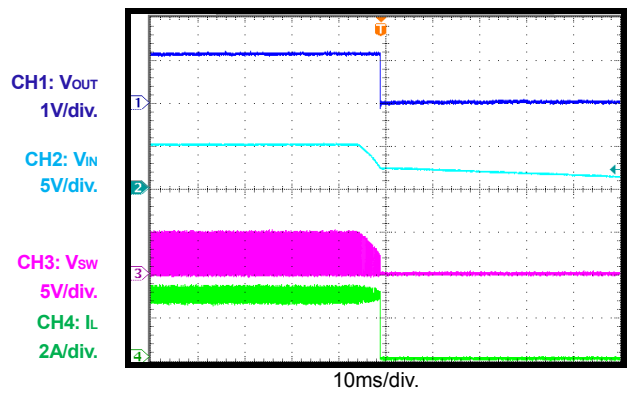

EVB TEST RESULTS *(continued)*

Performance waveforms are tested on the evaluation board.

$V_{IN} = 5V$, $V_{OUT} = 1.2V$, $C_{OUT} = 22\mu F$, $T_A = +25^\circ C$, unless otherwise noted.

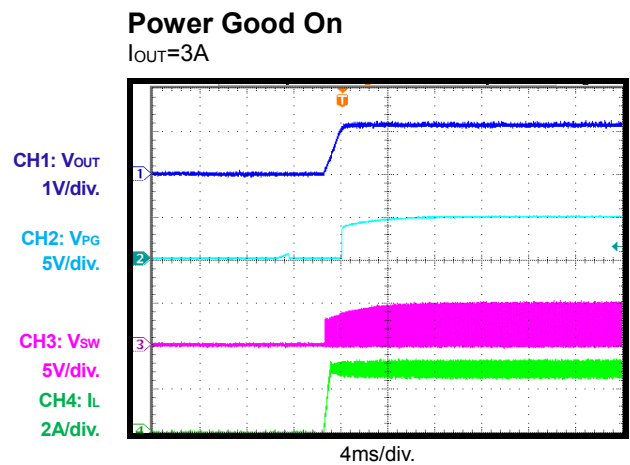
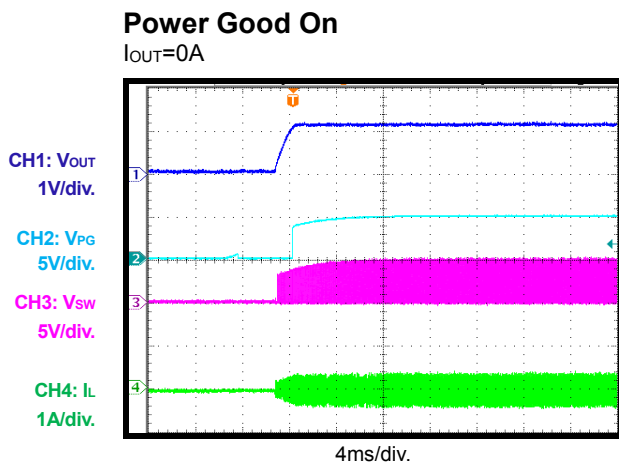
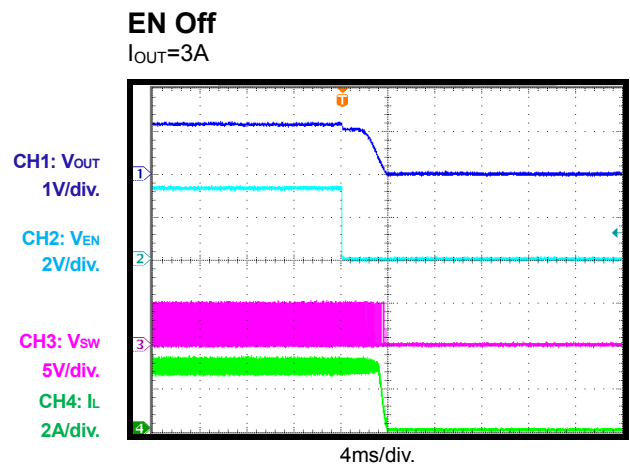
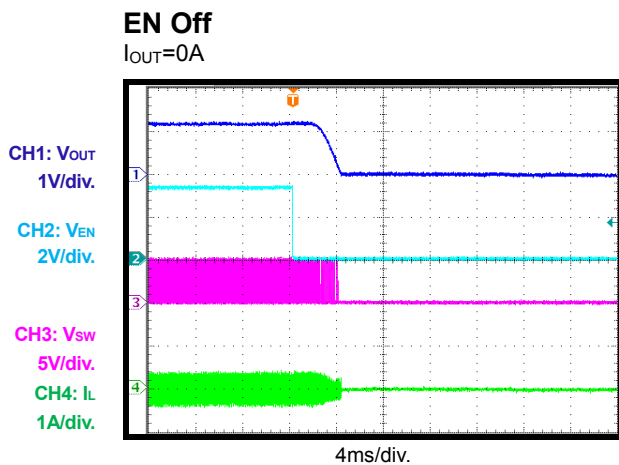
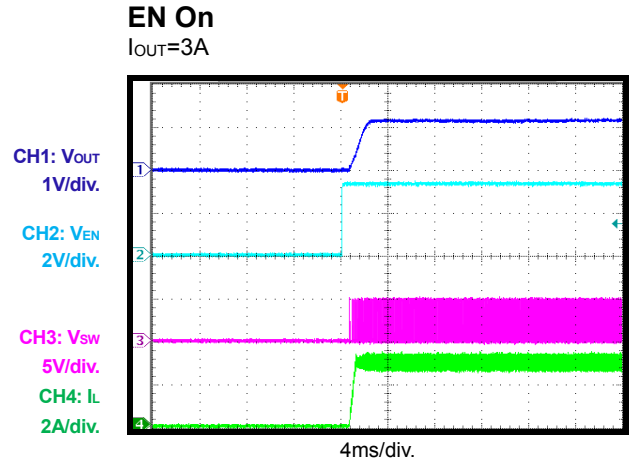
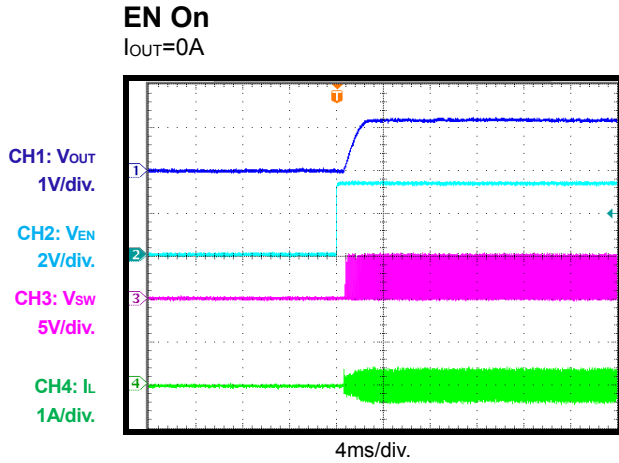

EVB TEST RESULTS (continued)

Performance waveforms are tested on the evaluation board.

$V_{IN} = 5V$, $V_{OUT} = 1.2V$, $C_{OUT} = 22\mu F$, $T_A = +25^\circ C$, unless otherwise noted.

Power Good Off

$I_{OUT} = 0A$

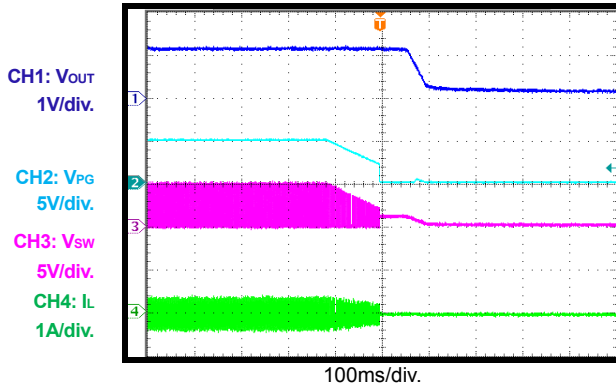

Power Good Off

$I_{OUT} = 3A$

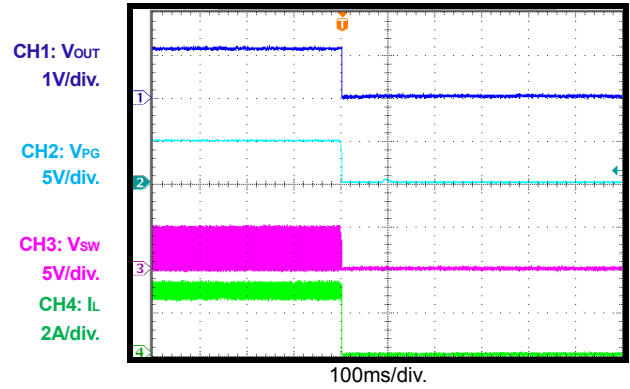

Load Transient

$I_{OUT} = 0A$ to $3A$, $2.5A/\mu s$

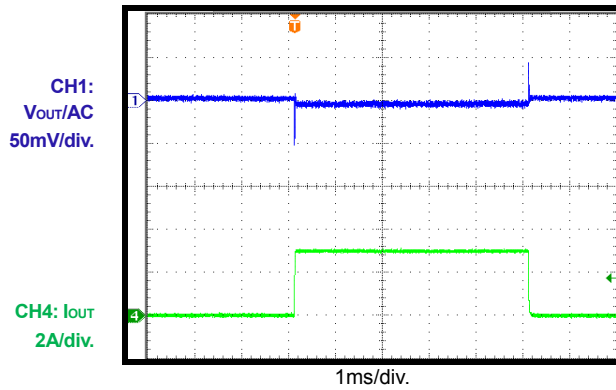

Load Transient

$I_{OUT} = 1.5A$ to $3A$, $2.5A/\mu s$

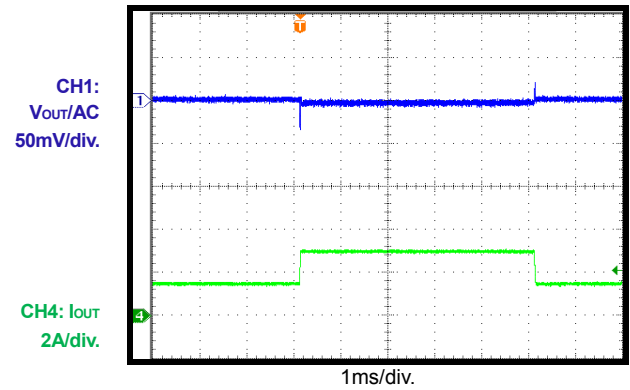

Short Entry

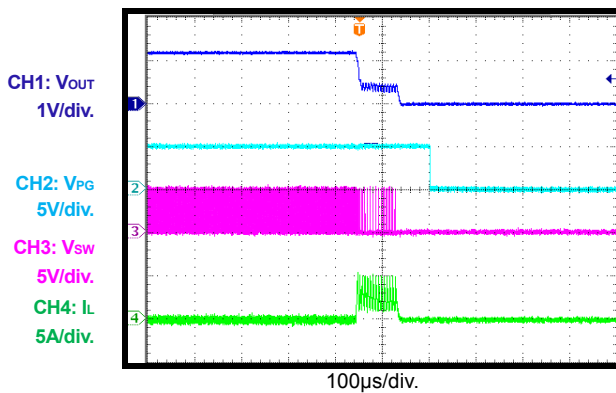

Short Steady State

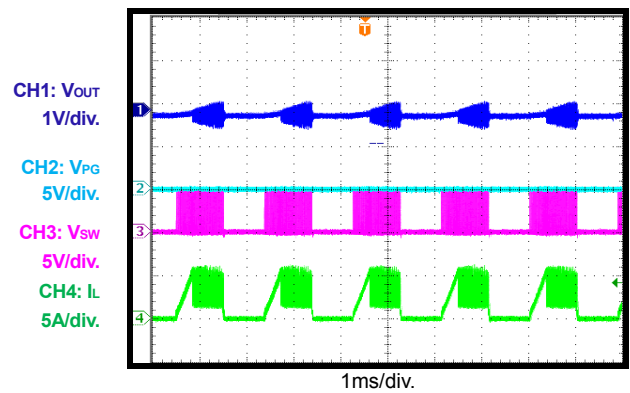

TYPICAL PERFORMANCE CHARACTERISTICS *(continued)*

Performance waveforms are tested on the evaluation board.

$V_{IN} = 5V$, $V_{OUT} = 1.2V$, $C_{OUT} = 22\mu F$, $T_A = +25^\circ C$, unless otherwise noted.

Short Recovery

$I_{OUT} = 0A$

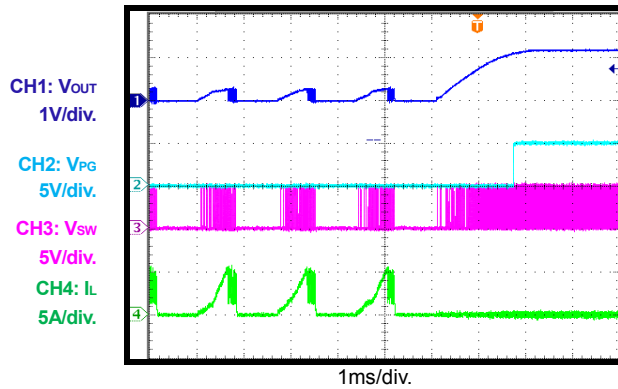

CIRCUIT BOARD LAYOUT

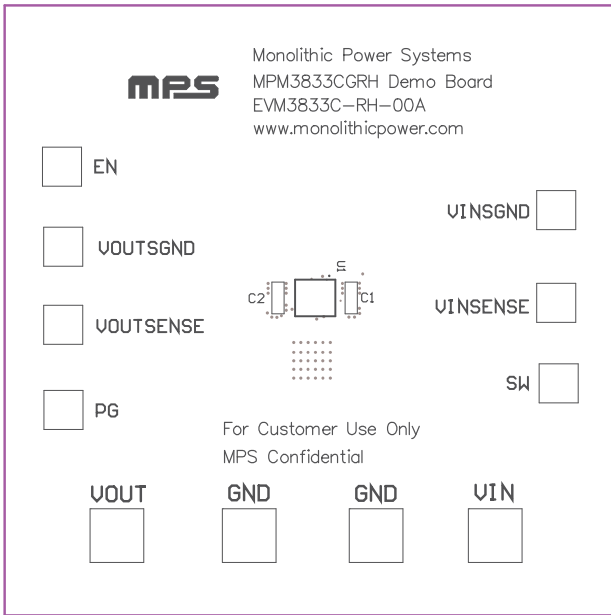

Figure 3—Top Silk Layer

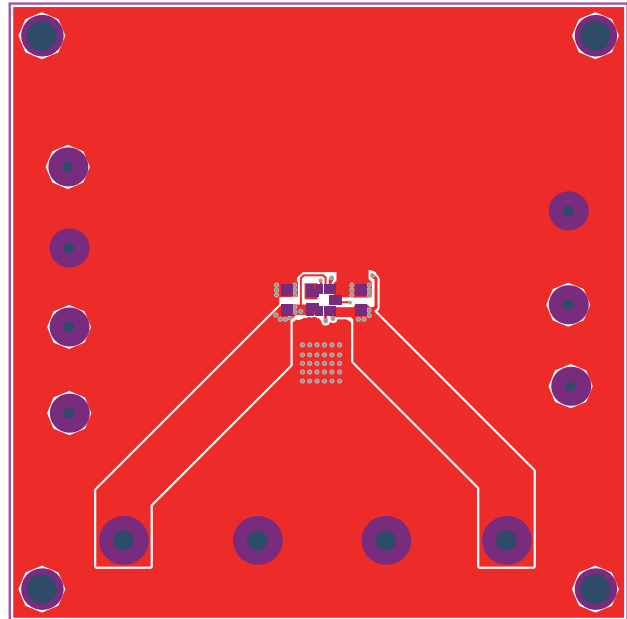

Figure 4—Top Layer

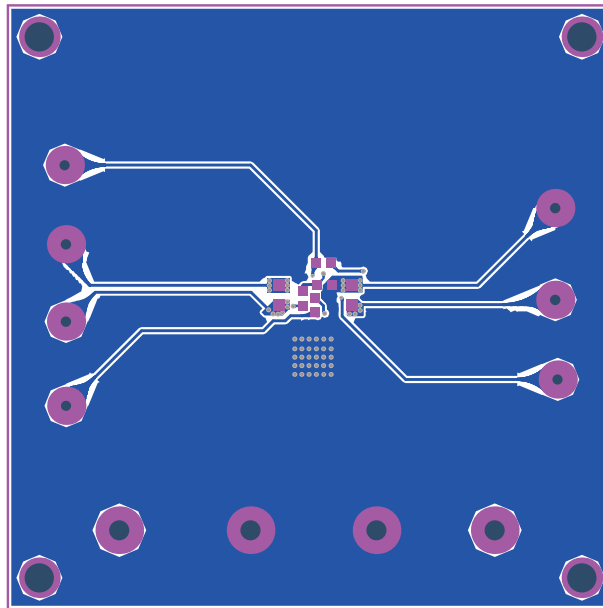

Figure 5—Bottom Layer

QUICK START GUIDE (MPM3833CGRH)

The output voltage of this board is set externally which can be regulated as low as 0.6V by operating from +2.7V to +6V input. The default output voltage of this board is set to 1.2V.

1. Connect the positive and negative terminals of the load to the VOUT and GND pins, respectively.
2. Preset the power supply output between 2.7V and 6V, and then turn off the power supply.
3. Connect the positive and negative terminals of the power supply output to the VIN and GND pins, respectively.
4. Turn the power supply on. The board will automatically start up.
5. The Output Voltage can be changed by varying R2. Choose R1 to 200k typically. R2 is then given by:

$$R2 = \frac{R1}{\frac{V_{out}}{0.6} - 1}$$

Example: For Vout= 1.8V, R1=200kΩ, R2=100kΩ.

NOTICE: The information in this document is subject to change without notice. Please contact MPS for current specifications. Users should warrant and guarantee that third party Intellectual Property rights are not infringed upon when integrating MPS products into any application. MPS will not assume any legal responsibility for any said applications.