

## N-Channel Enhancement Mode Power MOSFET

### Description

The G10N03S uses advanced trench technology to provide excellent  $R_{DS(ON)}$ , low gate charge. It can be used in a wide variety of applications.

### General Features

- $V_{DS}$  30V
- $I_D$  (at  $V_{GS} = 10V$ ) 13A
- $R_{DS(ON)}$  (at  $V_{GS} = 10V$ ) < 9m $\Omega$
- $R_{DS(ON)}$  (at  $V_{GS} = 4.5V$ ) < 16m $\Omega$
- 100% Avalanche Tested
- RoHS Compliant

### Application

- Power switch
- DC/DC converters

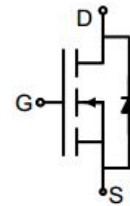

Schematic diagram

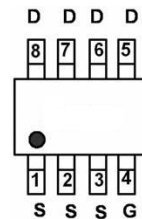

pin assignment



SOP-8

### Ordering Information

Device	Package	Marking	Packaging
G10N03S	SOP-8	G10N03	4000pcs/Reel

### Absolute Maximum Ratings $T_C = 25^\circ\text{C}$ , unless otherwise noted

Parameter	Symbol	Value	Unit
Drain-Source Voltage	$V_{DS}$	30	V
Continuous Drain Current	$I_D$	13	A
Pulsed Drain Current (note1)	$I_{DM}$	52	A
Gate-Source Voltage	$V_{GS}$	$\pm 20$	V
Power Dissipation	$P_D$	2.23	W
Single pulse avalanche energy (note2)	$E_{AS}$	42	mJ
Operating Junction and Storage Temperature Range	$T_J, T_{stg}$	-55 To 150	$^\circ\text{C}$

### Thermal Resistance

Parameter	Symbol	Value	Unit
Thermal Resistance, Junction-to-Ambient, $t \leq 10s$	$R_{thJA}$	56	$^\circ\text{C/W}$

Specifications $T_J = 25^\circ\text{C}$ , unless otherwise noted						
Parameter	Symbol	Test Conditions	Value			Unit
			Min.	Typ.	Max.	
<b>Static Parameters</b>						
Drain-Source Breakdown Voltage	$V_{(BR)DSS}$	$V_{GS} = 0V, I_D = 250\mu A$	30	--	--	V
Zero Gate Voltage Drain Current	$I_{DSS}$	$V_{DS} = 30V, V_{GS} = 0V$	--	--	1	$\mu A$
Gate-Source Leakage	$I_{GSS}$	$V_{GS} = \pm 20V$	--	--	$\pm 100$	nA
Gate-Source Threshold Voltage	$V_{GS(th)}$	$V_{DS} = V_{GS}, I_D = 250\mu A$	1.0	1.8	2.5	V
Drain-Source On-Resistance	$R_{DS(on)}$	$V_{GS} = 10V, I_D = 6A$	--	6	9	m $\Omega$
		$V_{GS} = 4.5V, I_D = 4A$	--	12	16	
Forward Transconductance	$g_{FS}$	$V_{GS} = 5V, I_D = 5A$	--	10.5	--	S
<b>Dynamic Parameters</b>						
Input Capacitance	$C_{iss}$	$V_{GS} = 0V,$ $V_{DS} = 15V,$ $f = 1.0\text{MHz}$	--	832	--	pF
Output Capacitance	$C_{oss}$		--	148	--	
Reverse Transfer Capacitance	$C_{rss}$		--	134	--	
Total Gate Charge	$Q_g$	$V_{DD} = 15V,$ $I_D = 6A,$ $V_{GS} = 10V$	--	17	--	nC
Gate-Source Charge	$Q_{gs}$		--	3	--	
Gate-Drain Charge	$Q_{gd}$		--	4	--	
Turn-on Delay Time	$t_{d(on)}$	$V_{DD} = 15V,$ $I_D = 6A,$ $R_G = 6\Omega$	--	5	--	ns
Turn-on Rise Time	$t_r$		--	12	--	
Turn-off Delay Time	$t_{d(off)}$		--	19	--	
Turn-off Fall Time	$t_f$		--	6	--	
<b>Drain-Source Body Diode Characteristics</b>						
Continuous Body Diode Current	$I_S$	$T_C = 25^\circ\text{C}$	--	--	13	A
Body Diode Voltage	$V_{SD}$	$T_J = 25^\circ\text{C}, I_{SD} = 6A, V_{GS} = 0V$	--	--	1.2	V
Reverse Recovery Charge	$Q_{rr}$	$I_F = 6A, V_{GS} = 0V$ $di/dt = 500A/\mu s$	--	23	--	nC
Reverse Recovery Time	$T_{rr}$		--	11	--	ns

### Notes

1. Repetitive Rating: Pulse width limited by maximum junction temperature
2. EAS condition :  $T_J = 25^\circ\text{C}, V_{DD} = 30V, V_{GS} = 10V, L = 0.5\text{mH}, R_G = 25\Omega$
3. Identical low side and high side switch with identical  $R_G$

### Gate Charge Test Circuit



### Switch Time Test Circuit

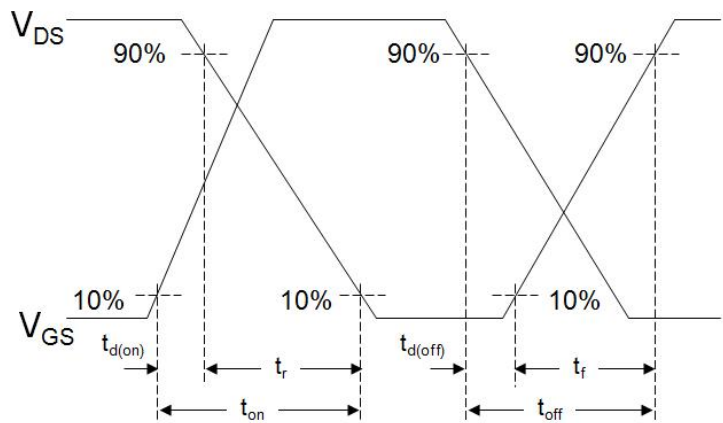
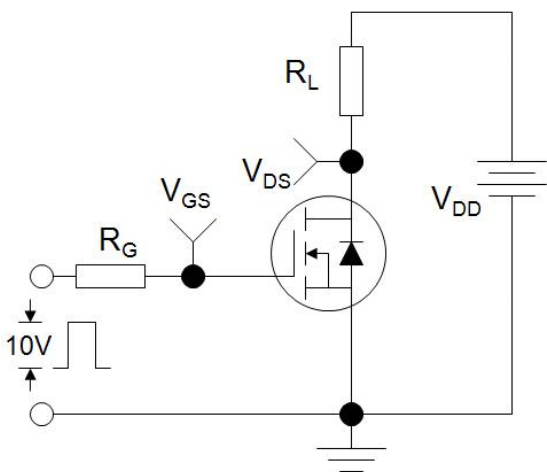

### EAS Test Circuit



Typical Characteristics  $T_J = 25^\circ\text{C}$ , unless otherwise noted

**Figure 1. Output Characteristics**

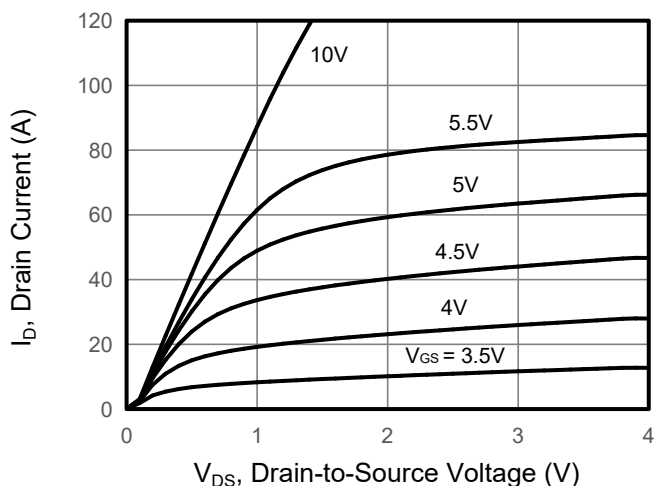

**Figure 2. Transfer Characteristics**

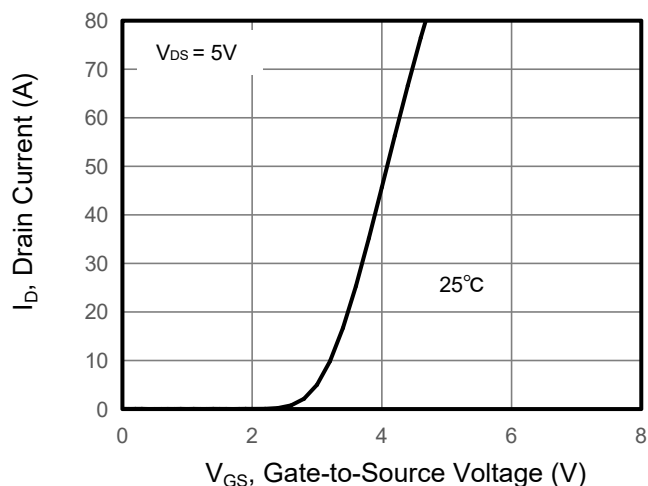

**Figure 3. Drain Source On Resistance**

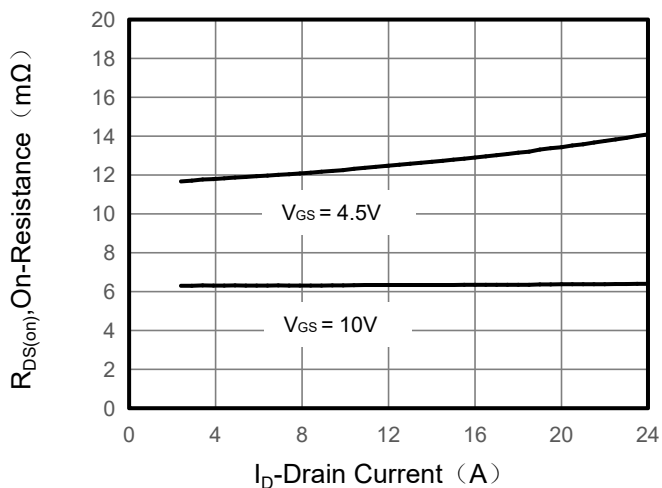

**Figure 4. Gate Charge**

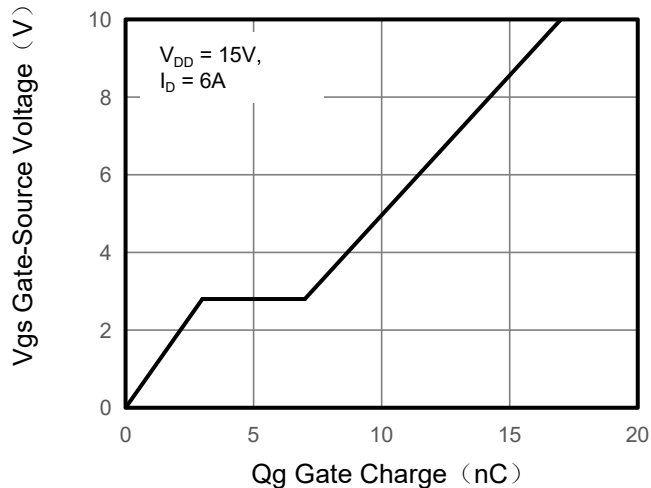

**Figure 5. Capacitance**

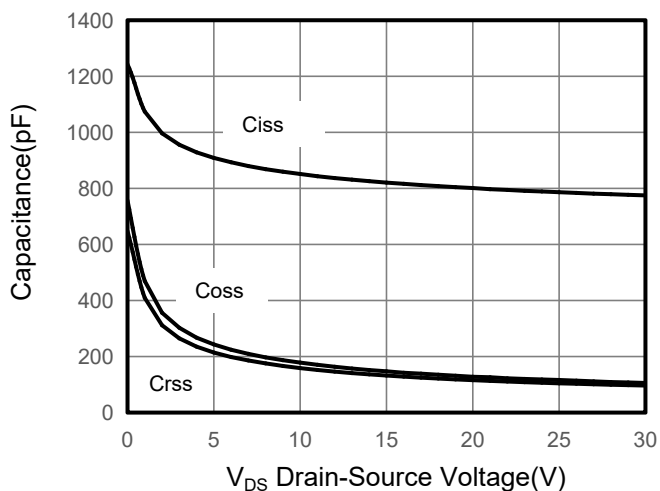

**Figure 6. Source-Drain Diode Forward**

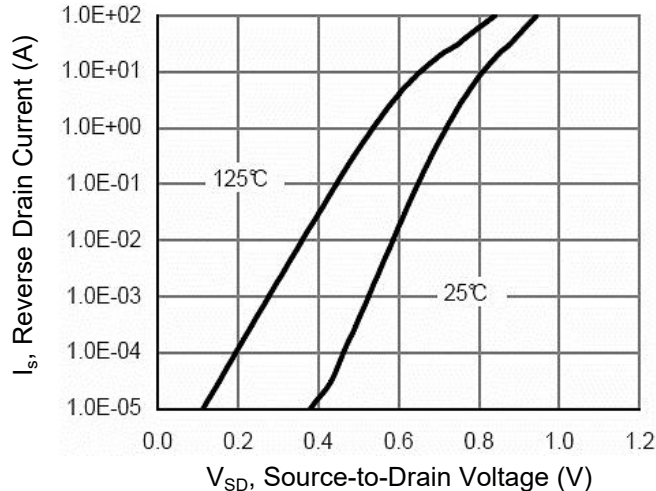

Typical Characteristics  $T_J = 25^\circ\text{C}$ , unless otherwise noted

Figure 7. Drain-Source On-Resistance

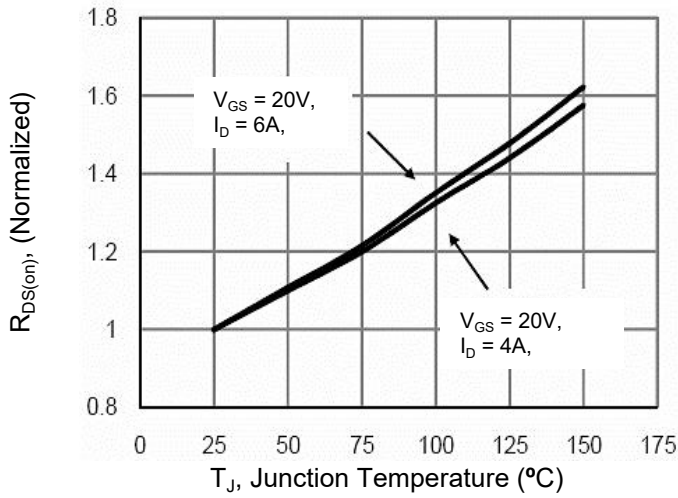

Figure 8. Safe Operation Area

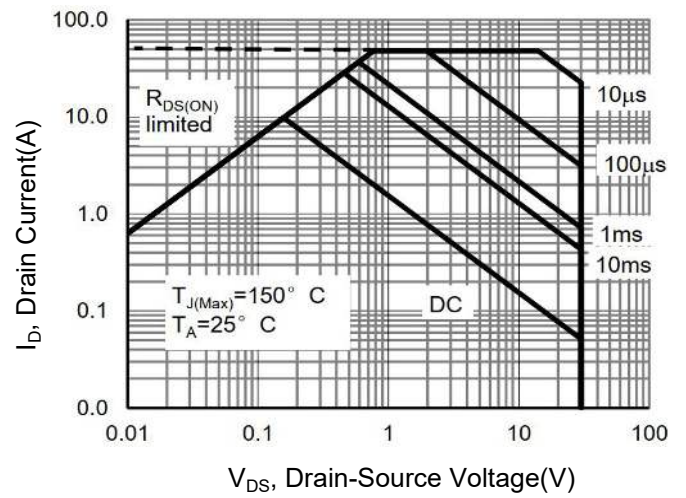
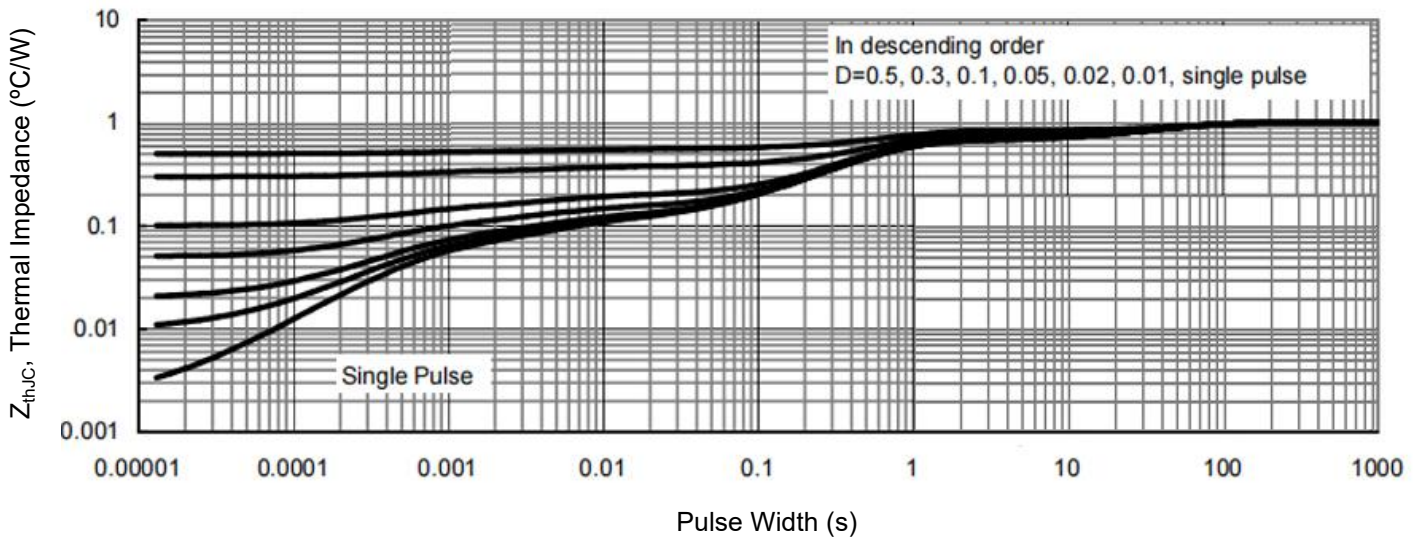
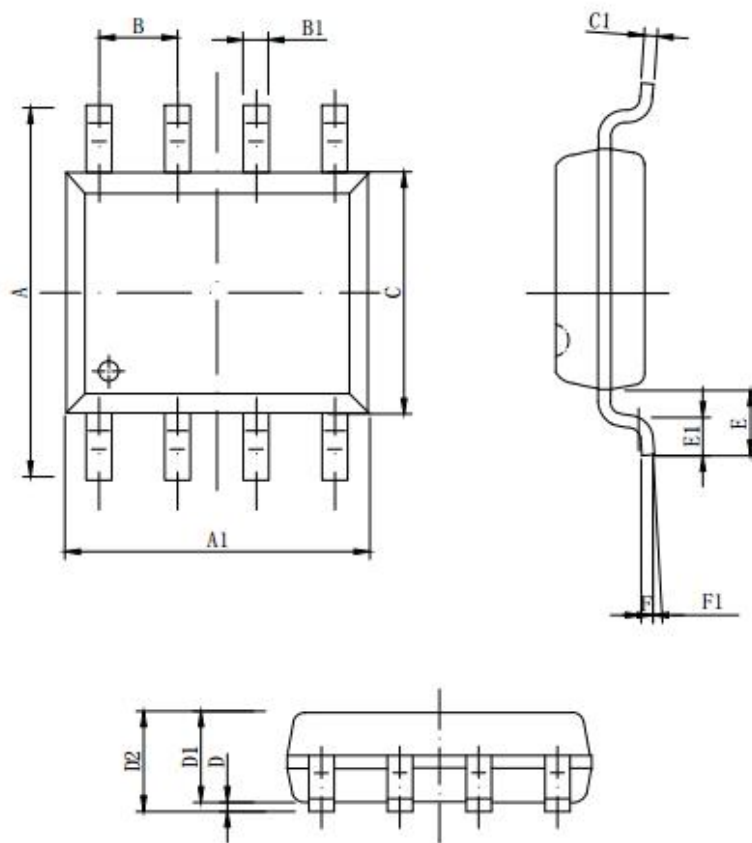

Figure 9. Normalized Maximum Transient Thermal Impedance



## SOP-8 Package Information



Symbol	Dimensions in Millimeters		
	MIN.	NOM.	MAX.
A	5.800	6.000	6.200
A1	4.800	4.900	5.000
B	1.270BSC		
B1	0.35 <sup>8x</sup>	0.40 <sup>8x</sup>	0.45 <sup>8x</sup>
C	3.780	3.880	3.980
C1	--	0.203	0.253
D	0.050	0.150	0.250
D1	1.350	1.450	1.550
D2	1.500	1.600	1.700
D2	1.500	1.600	1.700
E	1.060REF		
E1	0.400	0.700	0.100
F	0.250BSC		
F1	2°	4°	6°