



ON Semiconductor®

ON Semiconductor DATA SHEET

3LP03M — P-Channel Silicon MOSFET General-Purpose Switching Device Applications

Features

- Low ON-resistance.
- High-speed switching.
- 2.5V drive.
- High ESD Voltage (TYP 300V)
[Built-in one side diode for protection between Gate-to-Source].

Specifications

Absolute Maximum Ratings at Ta=25°C

Parameter	Symbol	Conditions	Ratings	Unit
Drain-to-Source Voltage	V _{DSS}		-30	V
Gate-to-Source Voltage (*1)	V _{GSS}		-10	V
Drain Current (DC)	I _D		-0.25	A
Drain Current (Pulse)	I _{DP}	PW≤10μs, duty cycle≤1%	-1	A
Allowable Power Dissipation	P _D		0.15	W
Channel Temperature	T _{ch}		150	°C
Storage Temperature	T _{stg}		-55 to +150	°C

(*1) : Note, when designing a circuit using this product, that it has a gate (oxide film) protection diode connected only between its gate and source.

Electrical Characteristics at Ta=25°C

Parameter	Symbol	Conditions	Ratings			Unit
			min	typ	max	
Drain-to-Source Breakdown Voltage	V _{(BR)DSS}	I _D = -1mA, V _{GS} =0	-30			V
Zero-Gate Voltage Drain Current	I _{DSS}	V _{DS} = -30V, V _{GS} =0			-1	μA
Gate-to-Source Leakage Current	I _{GSS}	V _{GS} = -8V, V _{DS} =0			-1	μA
Cutoff Voltage	V _{GS(off)}	V _{DS} = -10V, I _D = -100μA	-0.4		-1.4	V
Forward Transfer Admittance	y _{fs}	V _{DS} = -10V, I _D = -120mA	0.24	0.4		S
Static Drain-to-Source On-State Resistance	R _{DS(on)1}	I _D = -120mA, V _{GS} = -4V		1.5	1.9	Ω
	R _{DS(on)2}	I _D = -60mA, V _{GS} = -2.5V		2.0	2.8	Ω
	R _{DS(on)3}	I _D = -10mA, V _{GS} = -1.5V		4.0	8.0	Ω
Input Capacitance	C _{iss}	V _{DS} = -10V, f=1MHz		40		pF
Output Capacitance	C _{oss}	V _{DS} = -10V, f=1MHz		8		pF
Reverse Transfer Capacitance	C _{rss}	V _{DS} = -10V, f=1MHz		4.5		pF

Marking : XG

Continued on next page.

3LP03M

Continued from preceding page.

Parameter	Symbol	Conditions	Ratings			Unit
			min	typ	max	
Turn-ON Delay Time	$t_{d(on)}$	See specified Test Circuit.		9.5		ns
Rise Time	t_r	See specified Test Circuit.		5		ns
Turn-OFF Delay Time	$t_{d(off)}$	See specified Test Circuit.		15		ns
Fall Time	t_f	See specified Test Circuit.		13		ns
Total Gate Charge	Q_g	$V_{DS} = -10V, V_{GS} = -4V, I_D = -250mA$		0.8		nC
Gate-to-Source Charge	Q_{gs}	$V_{DS} = -10V, V_{GS} = -4V, I_D = -250mA$		0.3		nC
Gate-to-Drain "Miller" Charge	Q_{gd}	$V_{DS} = -10V, V_{GS} = -4V, I_D = -250mA$		0.2		nC
Diode Forward Voltage	V_{SD}	$I_S = -250mA, V_{GS} = 0$		-0.9	-1.2	V

Package Dimensions

unit : mm

2158A

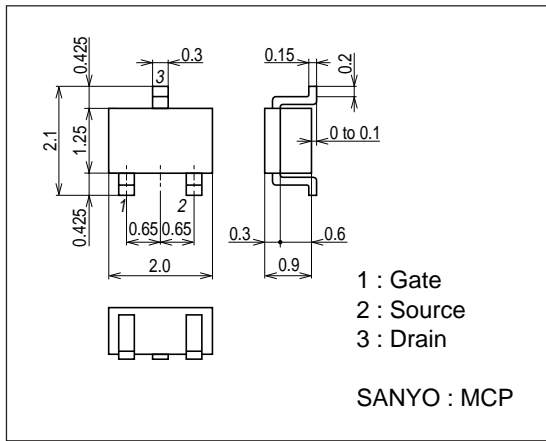

Switching Time Test Circuit

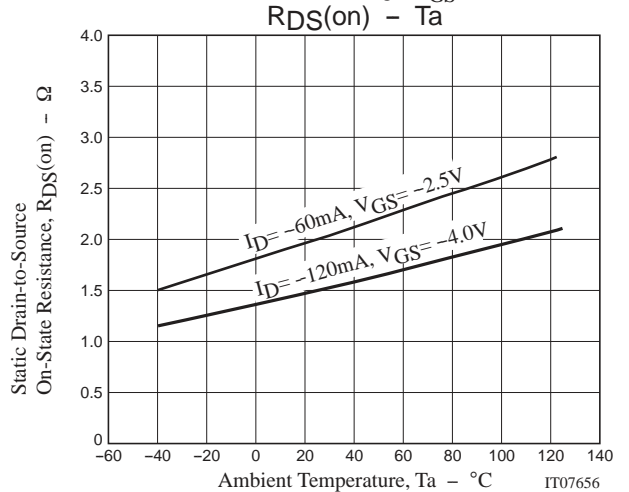
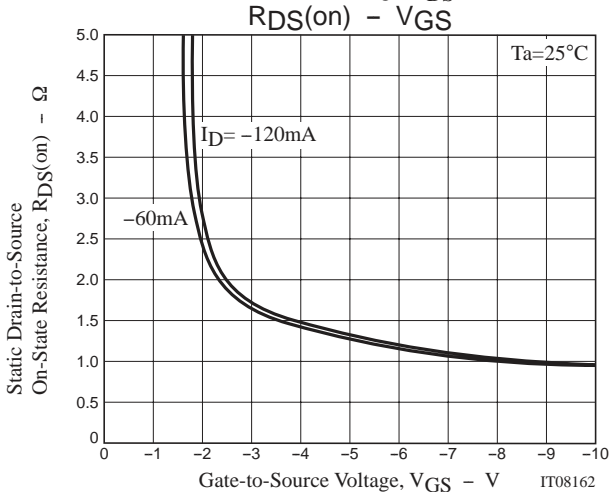
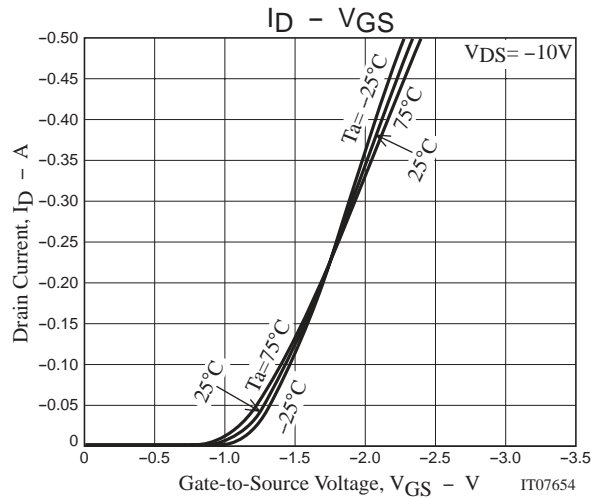
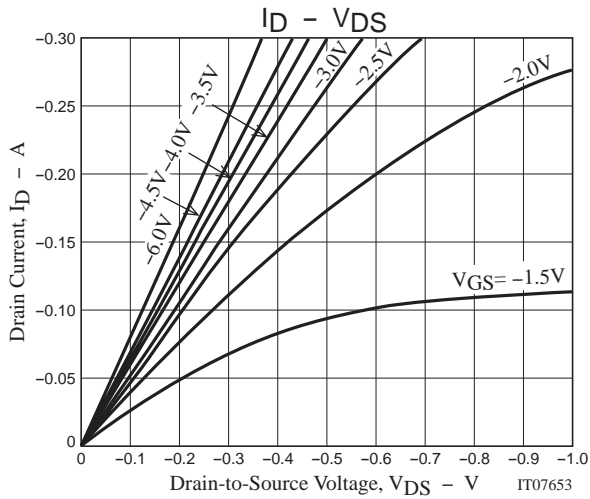
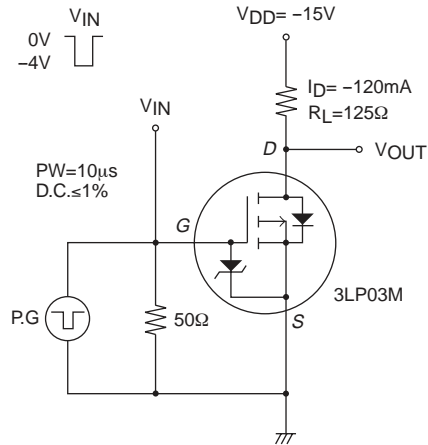

3LP03M

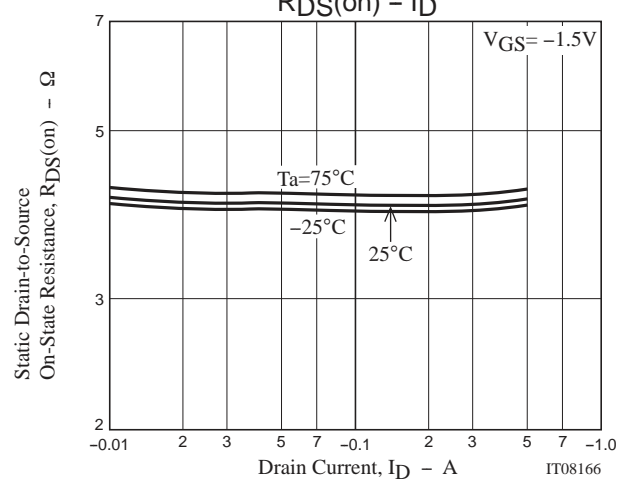
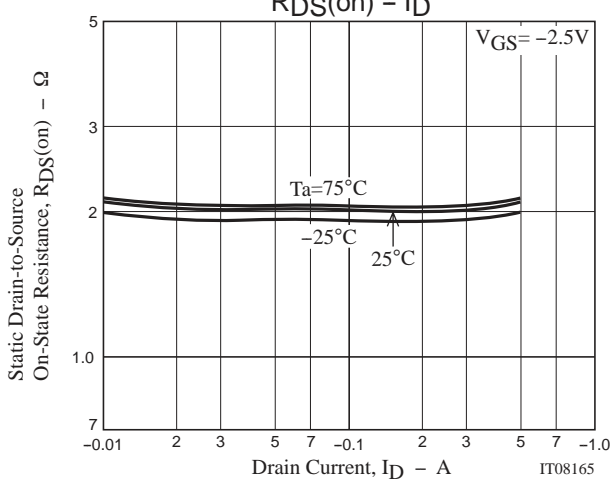
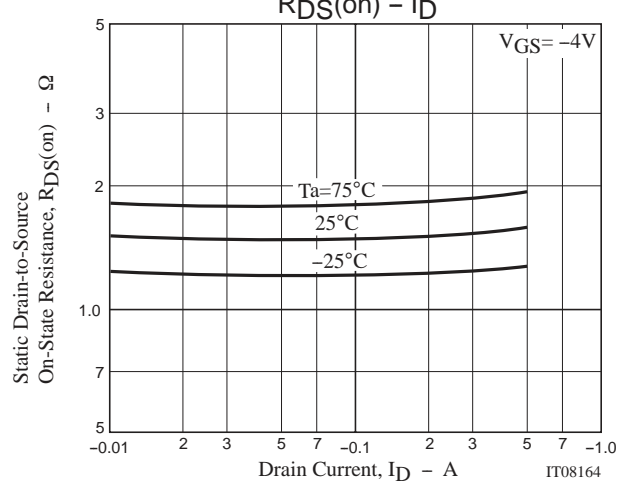
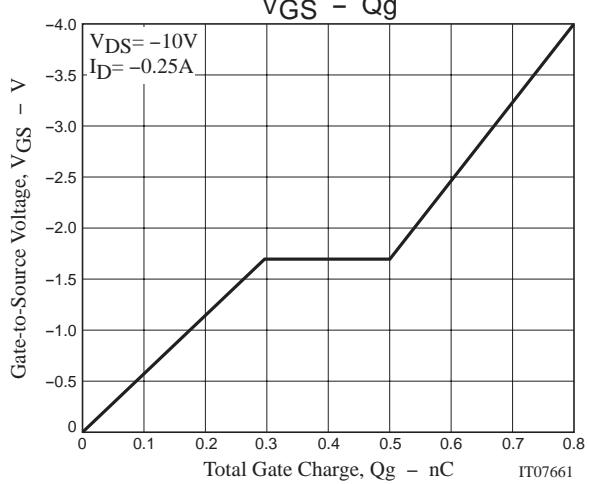
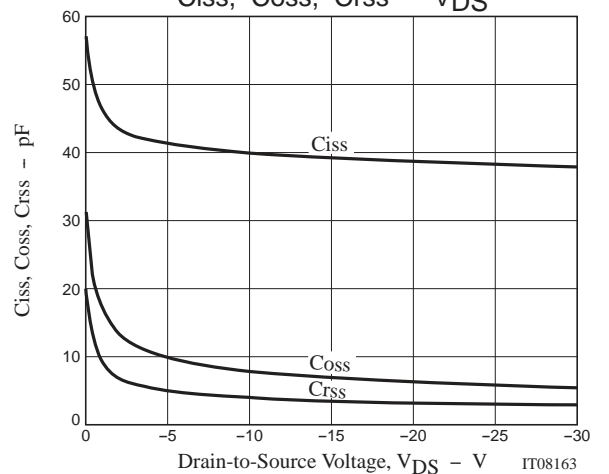
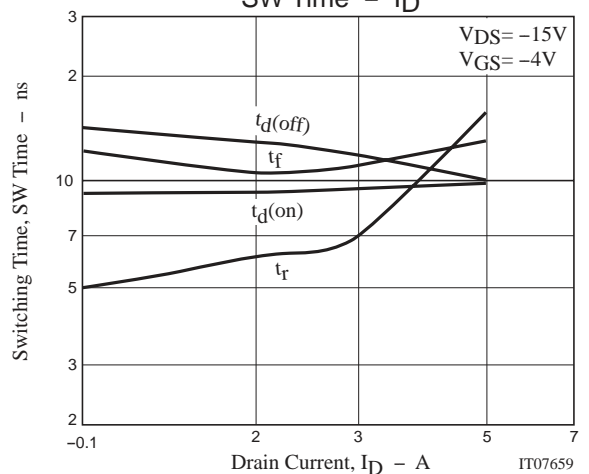
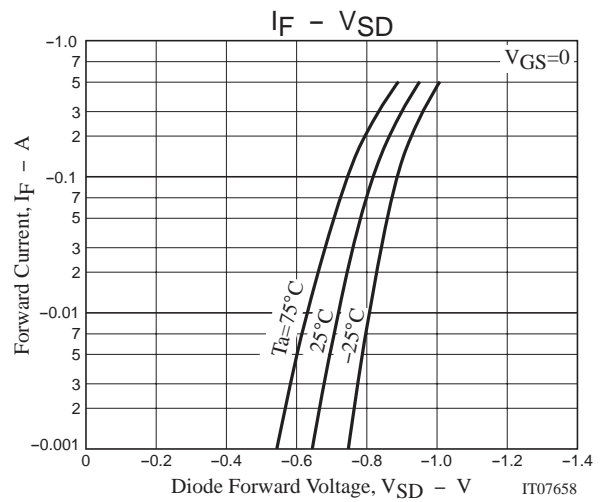
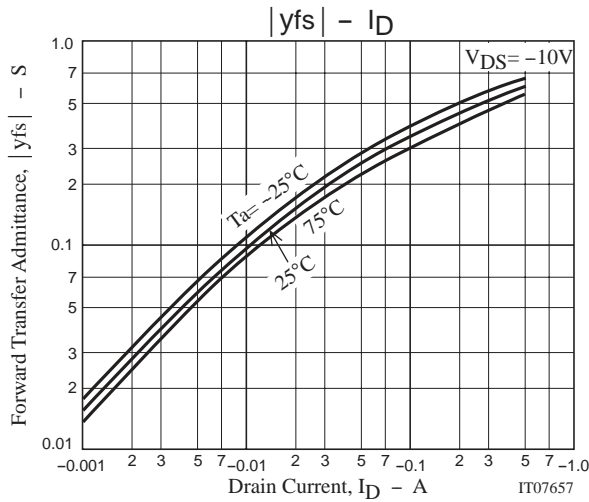

3LP03M

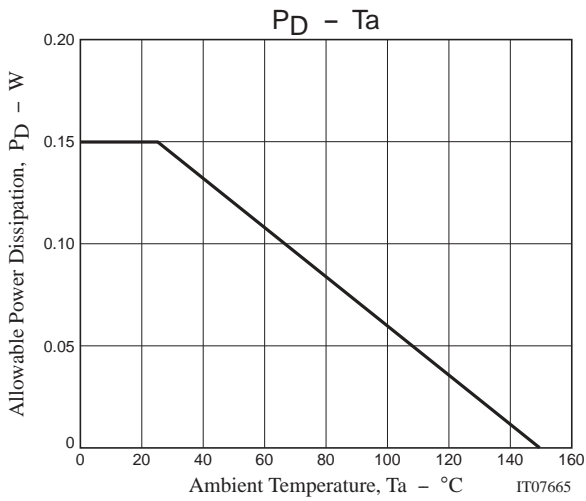

ON Semiconductor and the ON logo are registered trademarks of Semiconductor Components Industries, LLC (SCILLC). SCILLC reserves the right to make changes without further notice to any products herein. SCILLC makes no warranty, representation or guarantee regarding the suitability of its products for any particular purpose, nor does SCILLC assume any liability arising out of the application or use of any product or circuit, and specifically disclaims any and all liability, including without limitation special, consequential or incidental damages. SCILLC strives to supply high-quality high-reliability products and recommends adopting safety measures when designing equipment to avoid accidents or malfunctions. Such measures include but are not limited to protective circuits and error prevention circuits for safe design, redundant design, and structural design. "Typical" parameters which may be provided in SCILLC data sheets and/or specifications can and do vary in different applications and actual performance may vary over time. All operating parameters, including "Typicals," must be validated for each customer application by customer's technical experts. SCILLC shall not be held liable for any claim or suits with regard to a third party's intellectual property rights which has resulted from the use of the technical information and products mentioned above. SCILLC does not convey any license under its patent rights nor the rights of others. SCILLC products are not designed, intended, or authorized for use as components in systems intended for surgical implant into the body, or other applications intended to support or sustain life, or for any other application in which the failure of the SCILLC product could create a situation where personal injury or death may occur. Should Buyer purchase or use SCILLC products for any such unintended or unauthorized application, Buyer shall indemnify and hold SCILLC and its officers, employees, subsidiaries, affiliates, and distributors harmless against all claims, costs, damages, and expenses, and reasonable attorney fees arising out of, directly or indirectly, any claim of personal injury or death associated with such unintended or unauthorized use, even if such claim alleges that SCILLC was negligent regarding the design or manufacture of the part. SCILLC is an Equal Opportunity/Affirmative Action Employer. This literature is subject to all applicable copyright laws and is not for resale in any manner.

PUBLICATION ORDERING INFORMATION

LITERATURE FULFILLMENT:

Literature Distribution Center for ON Semiconductor
P.O. Box 5163, Denver, Colorado 80217 USA
Phone: 303-675-2175 or 800-344-3860 Toll Free USA/Canada
Fax: 303-675-2176 or 800-344-3867 Toll Free USA/Canada
Email: orderlit@onsemi.com

N. American Technical Support: 800-282-9855 Toll Free
USA/Canada.

Europe, Middle East and Africa Technical Support:
Phone: 421 33 790 2910

Japan Customer Focus Center
Phone: 81-3-5773-3850

ON Semiconductor Website: www.onsemi.com

Order Literature: <http://www.onsemi.com/orderlit>

For additional information, please contact your local
Sales Representative