







RECOMMENDED PCB LAYOUT

NOTES:

1. TERMINAL MAT'L: ALLOY C26000, CARTRIDGE BRASS
2. WAFER MAT'L: 30% GLASS FILLED LCP, 94V-0, COLOR BLACK.
3. TERMINAL PLATING:  
 OPTION 4 - 1.5µm MIN MATTE TIN OVERALL OVER 1.25µm NICKEL OVERALL  
 OPTION 1 - 2.5µm MIN MATTE TIN OVERALL OVER 1.25µm NICKEL OVERALL  
 OPTION 2 - 1.25µm NICKEL OVERALL 2.5µm MIN SELECT MATTE TIN PC TAIL  
 AREA 0.05-0.25µm SELECT GOLD CONTACT AREA  
 OPTION 3 - 1.25µm NICKEL OVERALL 2.5µm MIN SELECT MATTE TIN PC TAIL  
 AREA 0.75µm SELECT GOLD CONTACT AREA
4. HEADER ASSEMBLIES ARE TUBE PACKAGED PER PK-36518-340.
5. ALL THE POSITIONAL TOLERANCES SHOULD BE MEASURED AT TIP OF THE TERMINALS.
6. DATUMS SHOULD BE CONSIDERED FROM THE EDGES OF THE HOUSING.
7. POSITION TOLERANCE OF PIN AT MATING SIDE SHOULD BE MAINTAINED AT 0.3MM IN THE FINAL MODULE BY CUSTOMER.
8. [G] DENOTES DIMENSIONS THAT CAN BE QUALIFIED WITH A GAUGE
9. BLADE GEOMETRY DOES NOT CONFORM TO USCAR SPECIFICATIONS
10. PLEASE REFER USCAR WEBSITE FOR 1.5mm DIRECT CONNECT INTERFACE (SHROUD) DETAILS
11. PLEASE REFER SD-33472-0001 FOR 2 X 10 SHROUD DETAILS.

SYMBOLS	THIS DRAWING CONTAINS INFORMATION THAT IS PROPRIETARY TO MOLEX ELECTRONIC TECHNOLOGIES, LLC AND SHOULD NOT BE USED WITHOUT WRITTEN PERMISSION											
	DIMENSION UNITS	SCALE	CURRENT REV DESC: 11 PN's: 757571102,1182,1231,1321,1331,1421,1432, 1442, 5181,5221,5341 ARE OBSOLETE									
∇ = 0	mm	4:1	GENERAL TOLERANCES (UNLESS SPECIFIED)									
∇ = 0	ANGULAR TOL ± 0.5°		EC NO: 633184								PRODUCT CUSTOMER DRAWING	
∇ = 0	4 PLACES ±		DRWN: RYELAVATTITH 2020/02/26									
∇ = 0	3 PLACES ±		CHK'D: RYELAVATTITH 2020/03/02								DOC TYPE PSD	
∇ = 0	2 PLACES ± 0.13		APPR: SNAYAK01 2020/03/02									
∇ = 0	1 PLACE ± 0.25		INITIAL REVISION:								REVISION <b>G4</b>	
∇ = 0	0 PLACES ±		DRWN: TMCLELL 2005/03/10									
∇ = 0	DRAFT WHERE APPLICABLE MUST REMAIN WITHIN DIMENSIONS		THIRD ANGLE PROJECTION		DRAWING		SERIES		CUSTOMER		SHEET NUMBER	
∇ = 0			A2-SIZE		75757		GENERAL MARKET		1 OF 2			

2 x 2	1	75757-5121		3.05	16.09	75757-1121		3.05	11.20	75757-1122	OBSOLETE	4.75	11.20	7.0	3.50 REF
	2	75757-5221	OBSOLETE			75757-1221				75757-1222	OBSOLETE				
	3	75757-5321	OBSOLETE			75757-1321	OBSOLETE			75757-1322	OBSOLETE				
	4	75757-5421				75757-1421	OBSOLETE			75757-1422	OBSOLETE				
2 x 3	1	75757-5131		3.05	16.09	75757-1131		3.05	11.20	75757-1132	OBSOLETE	4.75	11.20	10.5	7.00
	2	75757-5231	OBSOLETE			75757-1231	OBSOLETE			75757-1232	OBSOLETE				
	3	75757-5331	OBSOLETE			75757-1331	OBSOLETE			75757-1332	OBSOLETE				
	4	75757-5431				75757-1431				75757-1432	OBSOLETE				
2 x 4	1	75757-5141		3.05	16.09	75757-1141	OBSOLETE	3.05	11.20	75757-1142	OBSOLETE	4.75	11.20	14.0	10.50
	2	75757-5241				75757-1241				75757-1242	OBSOLETE				
	3	75757-5341	OBSOLETE			75757-1341	OBSOLETE			75757-1342	OBSOLETE				
	4	75757-5441				75757-1441				75757-1442	OBSOLETE				
2 x 6	1	75757-5161		3.05	16.09	75757-1161		3.05	11.20	75757-1162	OBSOLETE	4.75	11.20	21.0	17.50
	2	75757-5261				75757-1261				75757-1262	OBSOLETE				
	3	75757-5361				75757-1361	OBSOLETE			75757-1362	OBSOLETE				
	4	75757-5461				75757-1461				75757-1462	OBSOLETE				
2 x 8	1	75757-5181	OBSOLETE	3.05	16.09	75757-1181		3.05	11.20	75757-1182	OBSOLETE	4.75	11.20	28.0	24.50
	2	75757-5281	OBSOLETE			75757-1281	OBSOLETE			75757-1282	OBSOLETE				
	3	75757-5381				75757-1381	OBSOLETE			75757-1382	OBSOLETE				
	4	75757-5481				75757-1481				75757-1482	OBSOLETE				
2 x 10	1	75757-5101		3.05	16.09	75757-1101		3.05	11.20	75757-1102	OBSOLETE	4.75	11.20	35.0	31.50
	2	75757-5201				75757-1201	OBSOLETE			75757-1202	OBSOLETE				
	3	75757-5301				75757-1301	OBSOLETE			75757-1302	OBSOLETE				
	4	75757-5401				75757-1401				75757-1402	OBSOLETE				
CKT SIZE	PLATING OPTION	MATERIAL NUMBER	STATUS	"C" DIM	"F" DIM	MATERIAL NUMBER	STATUS	"C" DIM	"F" DIM	MATERIAL NUMBER	STATUS	"C" DIM	"F" DIM	"A" DIM	"B" DIM

THIS DRAWING CONTAINS INFORMATION THAT IS PROPRIETARY TO MOLEX ELECTRONIC TECHNOLOGIES, LLC AND SHOULD NOT BE USED WITHOUT WRITTEN PERMISSION																						
<b>SYMBOLS</b>  = 0  = 0  = 0  = 0  = 0  = 0  = 0	DIMENSION UNITS: <b>mm</b> SCALE: <b>NTS</b>		CURRENT REV DESC: 11 PN's: 757571102,1182,1231,1321,1331,1421,1432, 1442, 5181,5221,5341 ARE OBSOLETE																			
	GENERAL TOLERANCES (UNLESS SPECIFIED) ANGULAR TOL ± 0.5°											<b>molex</b>										
	EC NO: 633184 DRWN: RYELAVATTITH 2020/02/26 CHK'D: RYELAVATTITH 2020/03/02 APPR: SNAYAK01 2020/03/02											MX150 DUAL ROW UNSHROUDED VERTICAL HEADER ASSEMBLY										
	INITIAL REVISION: DRWN: TMCLELL 2005/03/10 APPR: MBANAKIS 2005/03/15											PRODUCT CUSTOMER DRAWING										
	DRAFT WHERE APPLICABLE MUST REMAIN WITHIN DIMENSIONS											THIRD ANGLE PROJECTION		DRAWING: <b>A2-SIZE</b>		SERIES: <b>75757</b>		DOCUMENT NUMBER: <b>SD-75757-002</b>		DOC TYPE: <b>PSD</b>	DOC PART: <b>001</b>	REVISION: <b>G4</b>
	MATERIAL NUMBER: SEE TABLE											CUSTOMER: GENERAL MARKET					SHEET NUMBER: 2 OF 2					

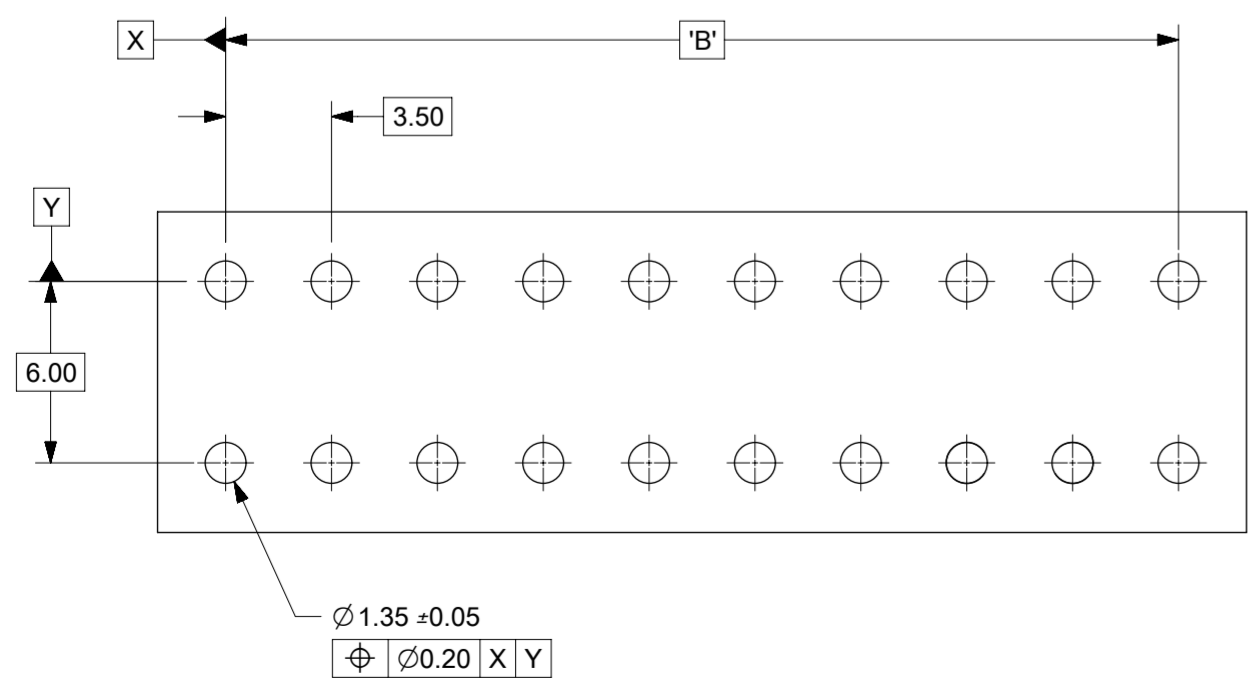
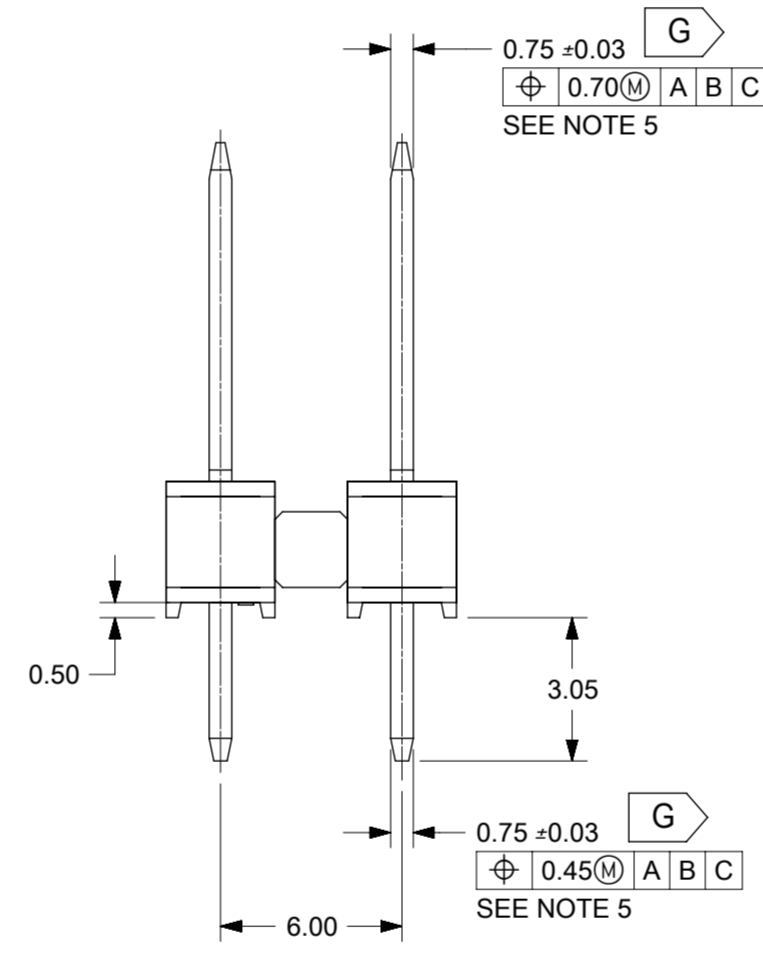
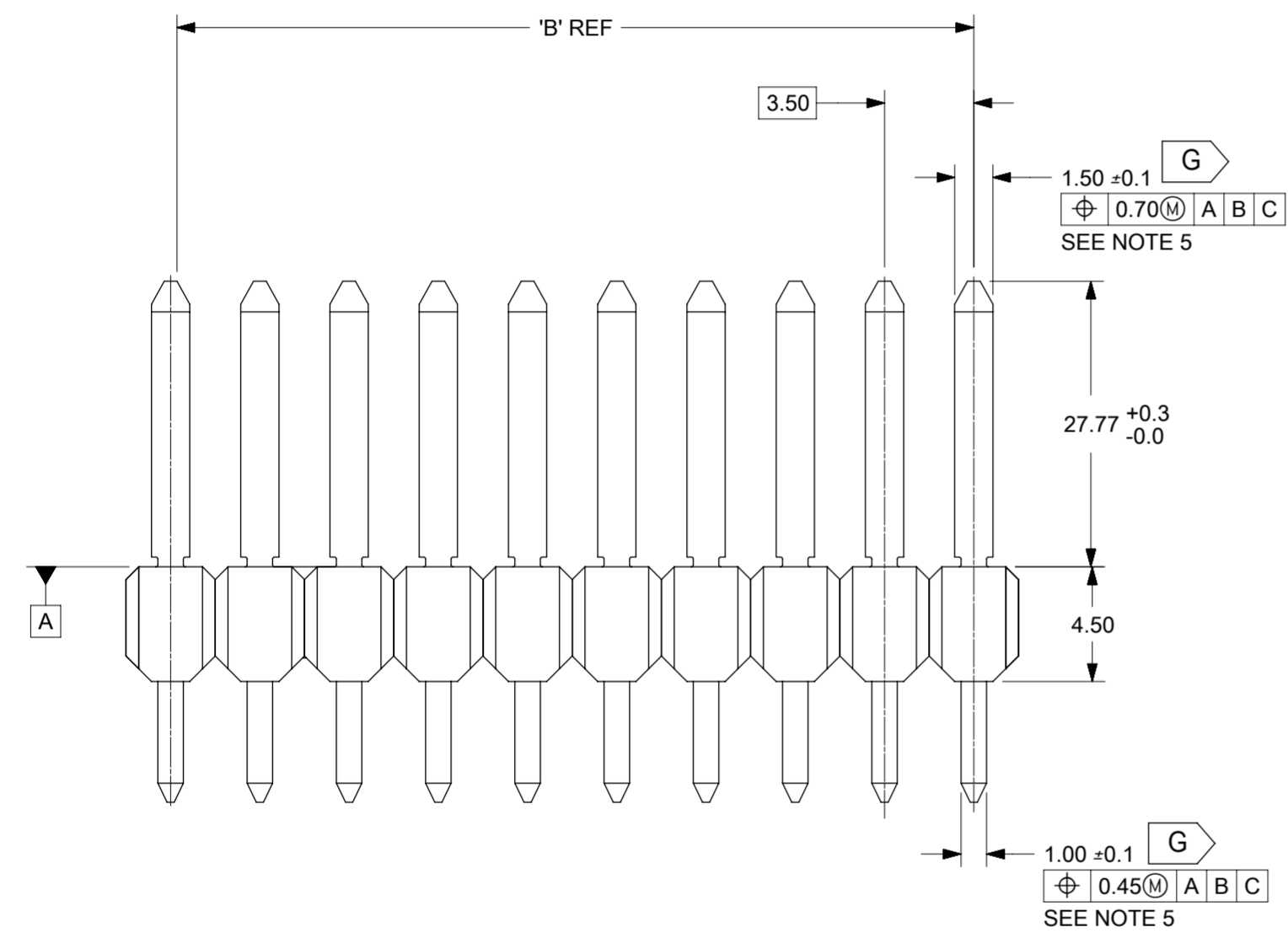
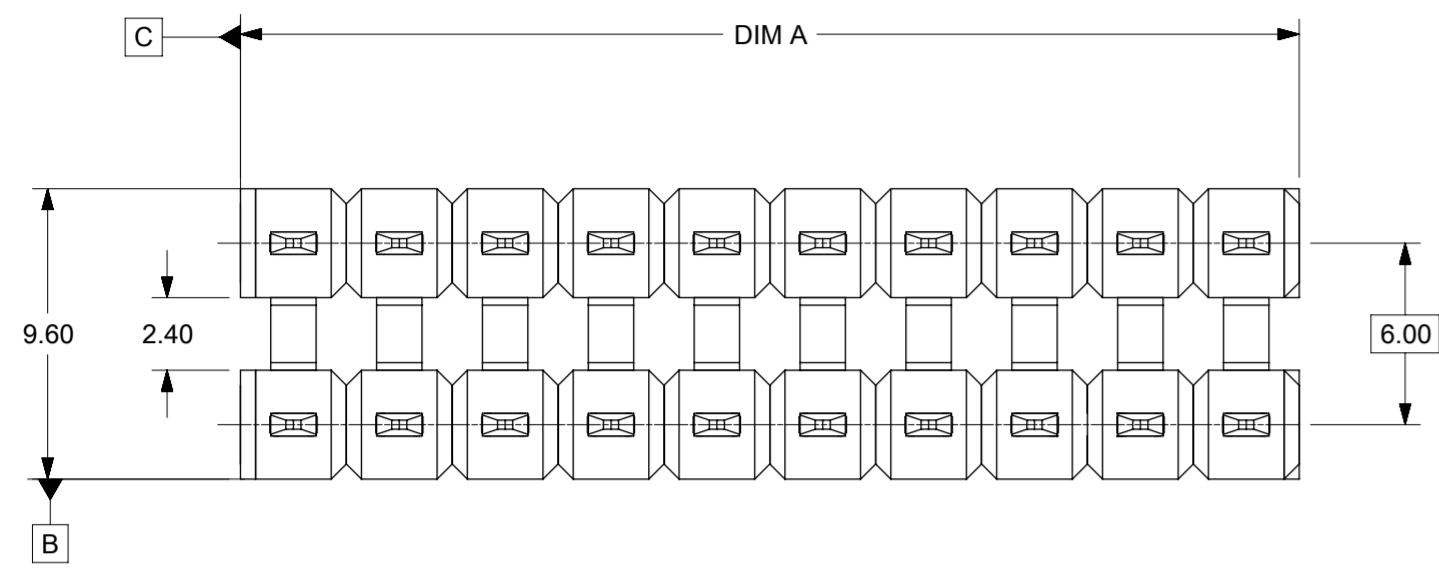

RECOMMENDED PCB LAYOUT

NOTES:

1. TERMINAL MAT'L: ALLOY C26000, CARTRIDGE BRASS
2. WAFER MAT'L: 30% GLASS FILLED LCP, 94V-0, COLOR BLACK.
3. TERMINAL PLATING:  
 OPTION 4 - 1.5µm MIN MATTE TIN OVERALL OVER 1.25µm NICKEL OVERALL  
 OPTION 1 - 2.5µm MIN MATTE TIN OVERALL OVER 1.25µm NICKEL OVERALL  
 OPTION 2 - 1.25µm NICKEL OVERALL 2.5µm MIN SELECT MATTE TIN PC TAIL  
 AREA 0.05-0.25µm SELECT GOLD CONTACT AREA  
 OPTION 3 - 1.25µm NICKEL OVERALL 2.5µm MIN SELECT MATTE TIN PC TAIL  
 AREA 0.75µm SELECT GOLD CONTACT AREA
4. HEADER ASSEMBLIES ARE TUBE PACKAGED PER PK-36518-340.
5. ALL THE POSITIONAL TOLERANCES SHOULD BE MEASURED AT TIP OF THE TERMINALS.
6. DATUMS SHOULD BE CONSIDERED FROM THE EDGES OF THE HOUSING.
7. POSITION TOLERANCE OF PIN AT MATING SIDE SHOULD BE MAINTAINED AT 0.3MM IN THE FINAL MODULE BY CUSTOMER.
8. [G] DENOTES DIMENSIONS THAT CAN BE QUALIFIED WITH A GAUGE
9. BLADE GEOMETRY DOES NOT CONFORM TO USCAR SPECIFICATIONS
10. PLEASE REFER USCAR WEBSITE FOR 1.5mm DIRECT CONNECT INTERFACE (SHROUD) DETAILS
11. PLEASE REFER SD-33472-0001 FOR 2 X 10 SHROUD DETAILS

THIS DRAWING CONTAINS INFORMATION THAT IS PROPRIETARY TO MOLEX ELECTRONIC TECHNOLOGIES, LLC AND SHOULD NOT BE USED WITHOUT WRITTEN PERMISSION											
SYMBOLS		DIMENSION UNITS	SCALE	CURRENT REV DESC:							
∇ = 0	∇ = 0	mm	4:1	EC NO: 624897							
∇ = 0	∇ = 0	GENERAL TOLERANCES (UNLESS SPECIFIED)		DRWN: RYELAVATTITH		2019/09/26		<b>MX150 DUAL ROW UNSHROUDED VERTICAL HEADER ASSEMBLY</b>			
∇ = 0	∇ = 0	ANGULAR TOL ± 0.5°		CHK'D: AKUMARMS		2019/10/01					
∇ = 0	∇ = 0	4 PLACES ±		APPR: SNAYAK01		2019/10/04		<b>PRODUCT CUSTOMER DRAWING</b>			
∇ = 0	∇ = 0	3 PLACES ±		INITIAL REVISION:							
∇ = 0	∇ = 0	2 PLACES ± 0.13		DRWN: DROSCA		2007/06/28		<b>SD-75757-003</b>			
∇ = 0	∇ = 0	1 PLACE ± 0.25		APPR: JCOMERCI		2007/07/23					
∇ = 0	∇ = 0	0 PLACES ±		DRAFT WHERE APPLICABLE MUST REMAIN WITHIN DIMENSIONS		THIRD ANGLE PROJECTION		<b>DOCUMENT NUMBER: SD-75757-003</b>			
∇ = 0	∇ = 0	DRAWING		SERIES		MATERIAL NUMBER				<b>PSD 001 A2</b>	
		A2-SIZE		75757		CUSTOMER		<b>GENERAL MARKET</b>			
						SHEET NUMBER		<b>1 OF 2</b>			

2 x 2	1	75757-6121	OBSOLETE	7.0	3.50 REF
	2	75757-6221	OBSOLETE		
	3	75757-6321	OBSOLETE		
	4	75757-6421			
2 x 3	1	75757-6131		10.5	7.00
	2	75757-6231	OBSOLETE		
	3	75757-6331	OBSOLETE		
	4	75757-6431			
2 x 4	1	75757-6141		14.0	10.50
	2	75757-6241	OBSOLETE		
	3	75757-6341	OBSOLETE		
	4	75757-6441			
2 x 6	1	75757-6161		21.0	17.50
	2	75757-6261	OBSOLETE		
	3	75757-6361	OBSOLETE		
	4	75757-6461	OBSOLETE		
2 x 8	1	75757-6181	OBSOLETE	28.0	24.50
	2	75757-6281	OBSOLETE		
	3	75757-6381	OBSOLETE		
	4	75757-6481	OBSOLETE		
2 x 10	1	75757-6101	OBSOLETE	35.0	31.50
	2	75757-6201	OBSOLETE		
	3	75757-6301	OBSOLETE		
	4	75757-6401	OBSOLETE		
CKT SIZE	PLATING OPTION	MATERIAL NUMBER	STATUS	"A" DIM	"B" DIM

THIS DRAWING CONTAINS INFORMATION THAT IS PROPRIETARY TO MOLEX ELECTRONIC TECHNOLOGIES, LLC AND SHOULD NOT BE USED WITHOUT WRITTEN PERMISSION												
SYMBOLS	DIMENSION UNITS	SCALE	CURRENT REV DESC:				DOCUMENT NUMBER			DOC TYPE	DOC PART	REVISION
= 0	mm	NTS	EC NO: 624897 DRWN: RYELAVATTITH 2019/09/26 CHK'D: AKUMARMS 2019/10/01 APPR: SNAYAK01 2019/10/04				<b>molex</b>  MX150 DUAL ROW UNSHROUDED VERTICAL HEADER ASSEMBLY			PRODUCT CUSTOMER DRAWING		
= 0	GENERAL TOLERANCES (UNLESS SPECIFIED)											
= 0	ANGULAR TOL ± 0.5°						INITIAL REVISION: DRWN: DROSCA 2007/06/28 APPR: JCOMERCI 2007/07/23				MATERIAL NUMBER SEE TABLE	
= 0	4 PLACES ±		THIRD ANGLE PROJECTION				DRAWING		SERIES			
= 0	3 PLACES ±		DRAFT WHERE APPLICABLE MUST REMAIN WITHIN DIMENSIONS				A2-SIZE		75757			
= 0	2 PLACES ± 0.13											
= 0	1 PLACE ± 0.25											
= 0	0 PLACES ±											

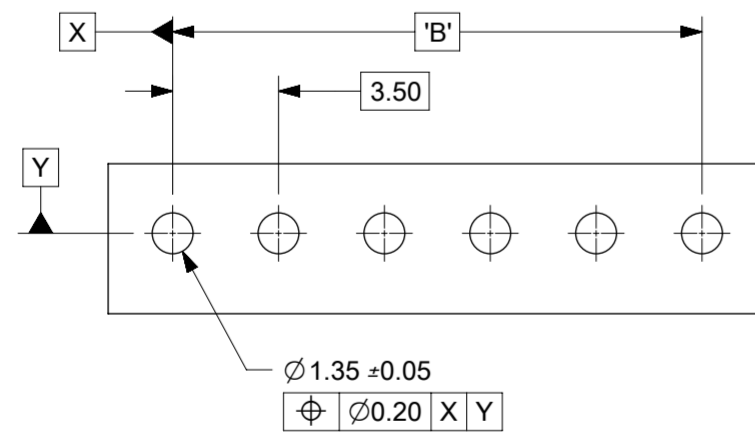
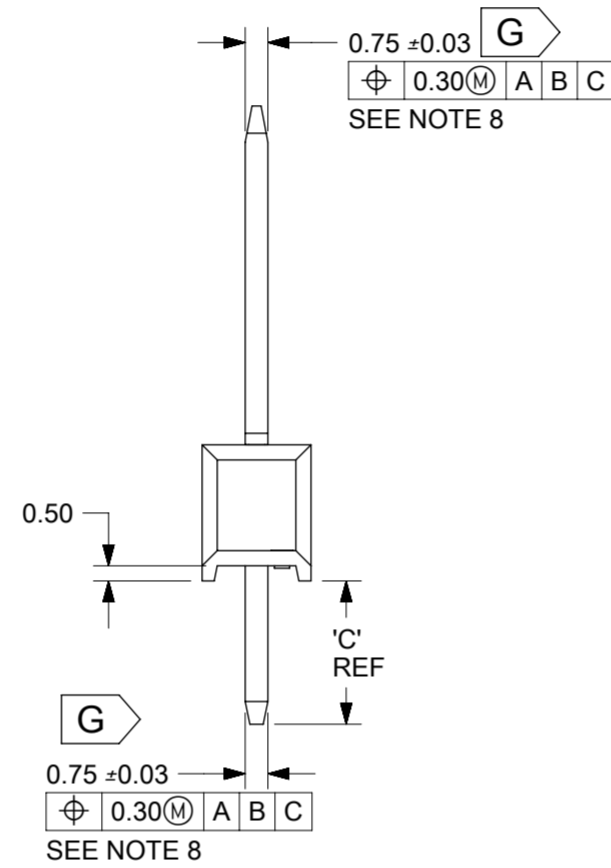
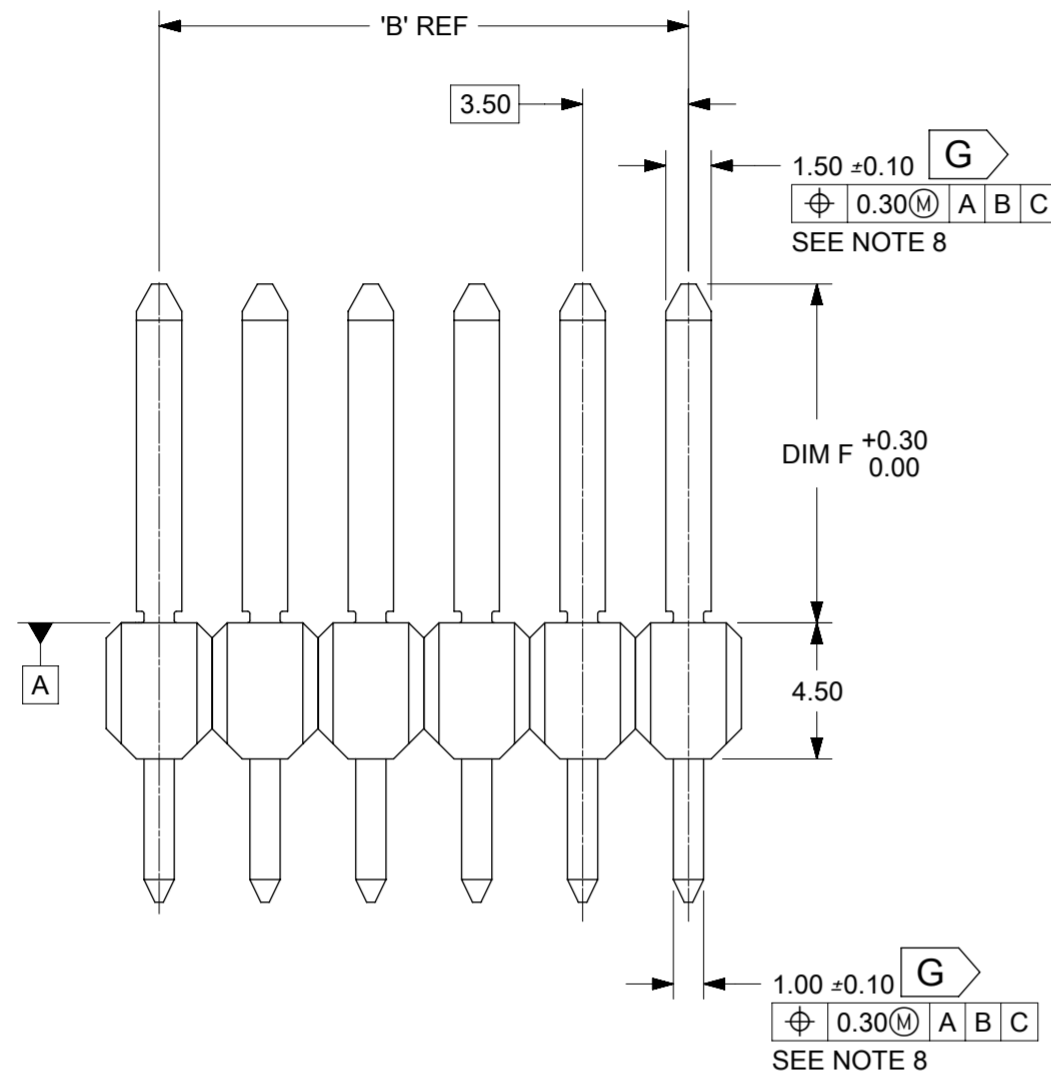
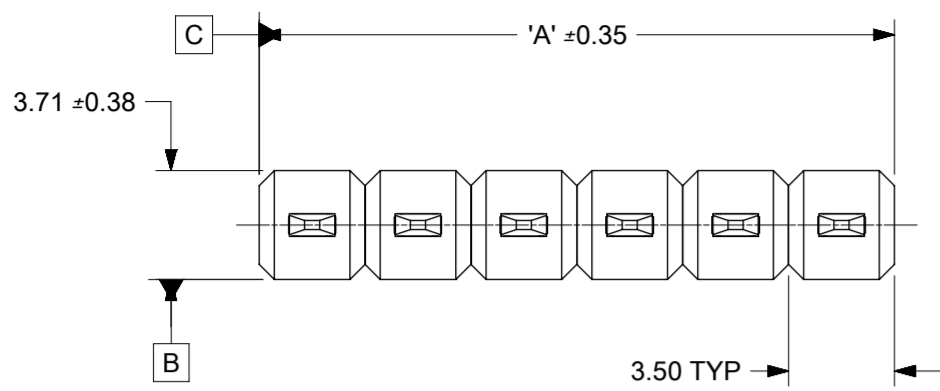

RECOMMENDED PCB LAYOUT

NOTES:

1. TERMINAL MAT'L: ALLOY C26000, CARTRIDGE BRASS
2. WAFER MAT'L: 30% GLASS FILLED LCP, 94V-0, COLOR BLACK.
3. TERMINAL PLATING:  
 OPTION 1 - 2.5µm MIN MATTE TIN OVERALL OVER 1.50µm MIN. NICKEL OVERALL  
 OPTION 2 - 1.50µm MIN. NICKEL OVERALL 4.00µm MIN SELECT MATTE TIN PC TAIL  
 AREA 0.05µm MIN SELECT GOLD CONTACT AREA  
 OPTION 3 - 1.50µm MIN. NICKEL OVERALL 4.00µm MIN SELECT MATTE TIN PC TAIL  
 AREA 0.50µm MIN. SELECT GOLD CONTACT AREA  
 OPTION 4 - 1.5µm MIN MATTE TIN OVERALL OVER 1.50µm MIN. NICKEL OVERALL
4. HEADER ASSEMBLIES ARE TUBE PACKAGED PER PK-36518-342.
5. MAXIMUM SKIVING ALLOWED: 1mm.
6. MAXIMUM CUT-OFF BURR ALLOWED: 0.30mm.
7. MAXIMUM DIG MARK ALLOWED: 0.45mm.
8. ALL THE POSITIONAL TOLERANCES SHOULD BE MEASURED AT TIP OF THE TERMINALS.
9. POSITION TOLERANCE OF PIN AT MATING SIDE SHOULD BE MAINTAINED AT 0.3MM IN THE FINAL MODULE BY CUSTOMER.
10. [G] DENOTES DIMENSIONS THAT CAN BE QUALIFIED WITH GAUGE
11. BLADE GEOMETRY DOES NOT CONFORM TO USCAR SPECIFICATIONS
12. PLEASE REFER USCAR WEBSITE FOR 1.5mm DIRECT CONNECT INTERFACE (SHROUD) DETAILS
13. PLEASE REFER SD-33472-0001 FOR 2 X 10 SHROUD DETAILS

SYMBOLS	THIS DRAWING CONTAINS INFORMATION THAT IS PROPRIETARY TO MOLEX ELECTRONIC TECHNOLOGIES, LLC AND SHOULD NOT BE USED WITHOUT WRITTEN PERMISSION										
	DIMENSION UNITS	SCALE	CURRENT REV DESC: Five PN's: 757570123, 757570133, 757570153, 757570221 & 757570443 ARE OBSOLETE								
∇ = 0	mm	4:1	GENERAL TOLERANCES (UNLESS SPECIFIED)								
∇ = 0	ANGULAR TOL ± 0.5°		EC NO: 633184							PRODUCT CUSTOMER DRAWING	
∇ = 0	4 PLACES ±		DRWN: RYELAVATTITH 2020/02/26								
∇ = 0	3 PLACES ±		CHK'D: RYELAVATTITH 2020/03/02							DOC TYPE <b>PSD</b>	
∇ = 0	2 PLACES ± 0.13		APPR: SNAYAK01 2020/03/02								
∇ = 0	1 PLACE ± 0.25		INITIAL REVISION:							REVISION <b>L5</b>	
∇ = 0	0 PLACES ±		DRWN: TMCLELL 2006/01/27								
∇ = 0	DRAFT WHERE APPLICABLE MUST REMAIN WITHIN DIMENSIONS		THIRD ANGLE PROJECTION		DRAWING		SERIES		CUSTOMER		
∇ = 0			A2-SIZE		75757		GENERAL MARKET		SHEET NUMBER 1 OF 2		

		TOOLED				TOOLED				TOOLED				TOOLED				STATUS			
1 x 2	1	75757-0121				75757-0122	OBSOLETE			75757-0123	OBSOLETE			75757-0124				7	3.5		
	2	75757-0221	OBSOLETE			75757-0222	OBSOLETE			75757-0223	OBSOLETE			75757-0224	OBSOLETE						
	3	75757-0321	OBSOLETE			75757-0322	OBSOLETE			75757-0323	OBSOLETE			75757-0324	OBSOLETE						
	4	75757-0421	OBSOLETE			75757-0422	OBSOLETE			75757-0423	OBSOLETE			75757-0424	OBSOLETE						
1 x 3	1	75757-0131				75757-0132	OBSOLETE			75757-0133	OBSOLETE			75757-0134				10.5	7.00		
	2	75757-0231	OBSOLETE			75757-0232	OBSOLETE			75757-0233	OBSOLETE			75757-0234	OBSOLETE						
	3	75757-0331	OBSOLETE			75757-0332	OBSOLETE			75757-0333	OBSOLETE			75757-0334	OBSOLETE						
	4	75757-0431	OBSOLETE			75757-0432	OBSOLETE			75757-0433	OBSOLETE			75757-0434	OBSOLETE						
1 x 4	1	75757-0141				75757-0142	OBSOLETE			75757-0143	OBSOLETE			75757-0144	OBSOLETE			14.0	10.50		
	2	75757-0241	OBSOLETE			75757-0242	OBSOLETE			75757-0243	OBSOLETE			75757-0244	OBSOLETE						
	3	75757-0341	OBSOLETE			75757-0342	OBSOLETE			75757-0343	OBSOLETE			75757-0344	OBSOLETE						
	4	75757-0441				75757-0442	OBSOLETE			75757-0443	OBSOLETE			75757-0444	OBSOLETE						
1 x 5	1	75757-0151				75757-0152	OBSOLETE			75757-0153	OBSOLETE			75757-0154	OBSOLETE			17.5	14.00		
	2	75757-0251	OBSOLETE			75757-0252	OBSOLETE			75757-0253	OBSOLETE			75757-0254	OBSOLETE						
	3	75757-0351	OBSOLETE			75757-0352	OBSOLETE			75757-0353	OBSOLETE			75757-0354	OBSOLETE						
	4	75757-0451	OBSOLETE			75757-0452	OBSOLETE			75757-0453	OBSOLETE			75757-0454	OBSOLETE						
1 x 6	1	75757-0161				75757-0162	OBSOLETE			75757-0163	OBSOLETE			75757-0164	OBSOLETE			21.0	17.50		
	2	75757-0261	OBSOLETE			75757-0262	OBSOLETE			75757-0263	OBSOLETE			75757-0264	OBSOLETE						
	3	75757-0361	OBSOLETE			75757-0362	OBSOLETE			75757-0363	OBSOLETE			75757-0364	OBSOLETE						
	4	75757-0461	OBSOLETE			75757-0462	OBSOLETE			75757-0463	OBSOLETE			75757-0464	OBSOLETE						
CKT SIZE	PLATING OPTION	MATERIAL NUMBER	STATUS	"F" DIM	"C" DIM	MATERIAL NUMBER	STATUS	"F" DIM	"C" DIM	MATERIAL NUMBER	STATUS	"F" DIM	"C" DIM	MATERIAL NUMBER	STATUS	"F" DIM	"C" DIM	"A" DIM	"B" DIM		

SYMBOLS										THIS DRAWING CONTAINS INFORMATION THAT IS PROPRIETARY TO MOLEX ELECTRONIC TECHNOLOGIES, LLC AND SHOULD NOT BE USED WITHOUT WRITTEN PERMISSION									
DIMENSION UNITS		SCALE		CURRENT REV DESC: Five PN's: 757570123, 757570133, 757570153, 757570221 & 757570443 ARE OBSOLETE															
mm		1:1		<p><b>molex</b></p> <p>MX150 SINGLE ROW UNSHROUDED VERTICAL HEADER ASSEMBLY</p> <p>PRODUCT CUSTOMER DRAWING</p> <p>DOCUMENT NUMBER: <b>SD-75757-010</b>   DOC TYPE: PSD   DOC PART: 001   REVISION: L5</p> <p>MATERIAL NUMBER: 75757   CUSTOMER: GENERAL MARKET   SHEET NUMBER: 2 OF 2</p>															
GENERAL TOLERANCES (UNLESS SPECIFIED)																			
ANGULAR TOL ± 0.5°																			
EC NO: 633184																			
▽ = 0	4 PLACES ±			DRWN: RYELAVATTITH 2020/02/26															
▽ = 0	3 PLACES ±			CHK'D: RYELAVATTITH 2020/03/02															
▽ = 0	2 PLACES ± 0.13			APPR: SNAYAK01 2020/03/02															
▽ = 0	1 PLACE ± 0.25			INITIAL REVISION:															
□ = 0	0 PLACES ±			DRWN: TMCLELL 2006/01/27															
■ = 0	DRAFT WHERE APPLICABLE MUST REMAIN WITHIN DIMENSIONS			THIRD ANGLE PROJECTION															
▽ = 0				DRAWING: A2-SIZE															
			SERIES: 75757																