

FS10-110-C2

Description:

The FS10-110-C2 is a series/parallel primary and dual secondary, split bobbin design which operates with either a parallel input of 115V or a series input of 230V. The secondaries are 5V @ 0.11A each. They can be used independently (up to 300V difference between them) or in series for double the voltage or in parallel for double the current. The split bobbin design eliminates the need for costly electrostatic shielding.

Electrical Specifications (@25C)

1. Maximum Power: 1.1VA
2. Primary: Series: 230V; Parallel: 115V
3. Secondaries: 5.0V @ 0.11A each
4. Voltage Regulation: 25% TYP @ full load to no load
5. Operating Temperature: -40C to 115C
6. Storage Temperature: -55C to 150C
7. Hipot tested 100% at 4200 VRMS pri to sec
8. Hipot tested 100% at 2160 VRMS sec to sec
9. Inherently Limited. No fusing required.

Construction:

Three flange bobbin construction with primaries and secondaries wound side by side for low capacitive coupling. UL Class F Insulation System (155°C).

Agency File:

UL: File E65390, UL 5085-1 & 3 (1585), Class 2 Transformers
 cUL: File E65390, UL 5085-1 & 3 (1585) For Canadian Use (CSA 22.2, No.66.3-06)
 TUV Certificate No.: R72120839, EN61558, Safety Isolating xfmr, general use



Dimensions:

Units in inches.

H	W	L	A	B	C	D	E	F
1.0 MAX	1.142 MAX	1.417 MAX	0.250±0.02	0.250±0.02	1.201±0.02	0.040	0.020	0.217±0.02

Weight: 0.17 lbs

Schematic:

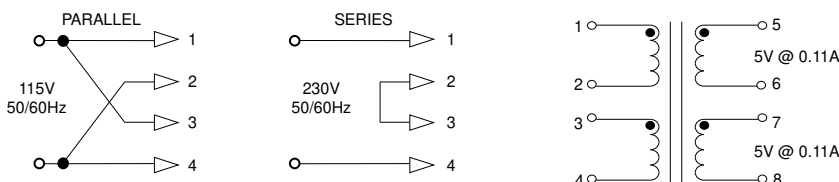

RoHS Compliance: As of manufacturing date February 2016, all standard products meet the requirements of 2015/863/EU, known as the RoHS 3 initiative.

Note: Order and shipping documentation may have a "-B" suffix; this indicates Bulk packaging but does not show on the actual part number marked on the transformer.

*Upon printing, this document is considered "uncontrolled". Please contact Triad Magnetics website for the most current version. For soldering and washing information please see <http://www.triadmagnetics.com/faq.html>

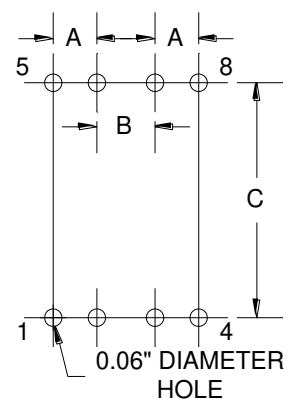
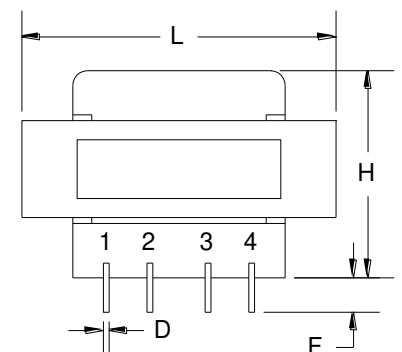
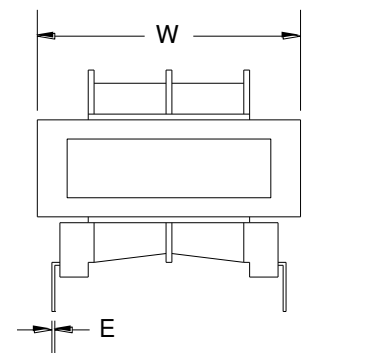

Board Layout