

# 12X10X4 PREMIUM SERIES



## Features and Benefits

- Quality material – bases, opaque covers and clear covers are all made of high-impact, UV resistant polycarbonate.
- Flexible interior mounting – features the unique and patented Integra adjustable depth “T-Rail” back panel mounting system (back panel and adjustable brackets sold separately).
- Wide range of sizes, configurations and accessories provides capabilities for every application.
- Features multiple bosses for easy installation of devices and DIN rails.
- Standard color – light gray with a gloss finish.
- UL-50 / c-UL Listed (files # E229365, # E207562)



Mounting Feet



Mounting Flanges



Mechanical and Thermal	Test Spec.	Unit	Premium Line
Instrumented Dart Impact @ 73° F		in-lbs.	565
Falling Ball Impact @ 73° F	UL-746	in-lbs.	900
Deflection Temperature @ 264 psi	ASTM D648	Deg. F	270
Modulus of Elasticity	ASTM D790	ksi	340
Temperature Range		Deg. F	-40 to 265
Flammable / UV Ratings	Test Spec.	Unit	Premium Line
Flame Rating - UL	UL 94	-	5VA
Outdoor UV Exposure	UL	-	F1

Part Number	4X IP66	6P IP68	Hinged Cover	Screw Cover	Opaque Cover	Clear Cover	Mounting Feet	Mounting Flange	Stainless Steel Locking Latch	Non-Metallic Locking Latch
H12104S	✓	✓		✓	✓		✓			
H12104SC	✓	✓		✓		✓	✓			
H12104SF	✓	✓		✓	✓			✓		
H12104SCF	✓	✓		✓		✓		✓		
H12104H	✓		✓	✓	✓		✓			
H12104HC	✓		✓	✓		✓	✓			
H12104HF	✓		✓	✓	✓			✓		
H12104HCF	✓		✓	✓		✓		✓		
H12104HLL*	✓		✓		✓		✓		✓	
H12104HCLL*	✓		✓			✓	✓		✓	
H12104HFLL	✓		✓		✓			✓	✓	
H12104HCFLL	✓		✓			✓		✓	✓	
H12104HNL	✓		✓		✓		✓			✓
H12104HCNL	✓		✓			✓	✓			✓
H12104HFNL	✓		✓		✓			✓		✓
H12104HCFNL	✓		✓			✓		✓		✓
H12104H-6P	✓	✓	✓	✓	✓		✓			
H12104HC-6P	✓	✓	✓	✓		✓	✓			
H12104HF-6P	✓	✓	✓	✓	✓			✓		
H12104HCF-6P	✓	✓	✓	✓		✓		✓		

\*POPULAR CONFIGURATIONS: Most popular configurations are available for *QuickShip*. Please send requests to [customerservice@integraenclosures.com](mailto:customerservice@integraenclosures.com) to take advantage of our *QuickShip* option.





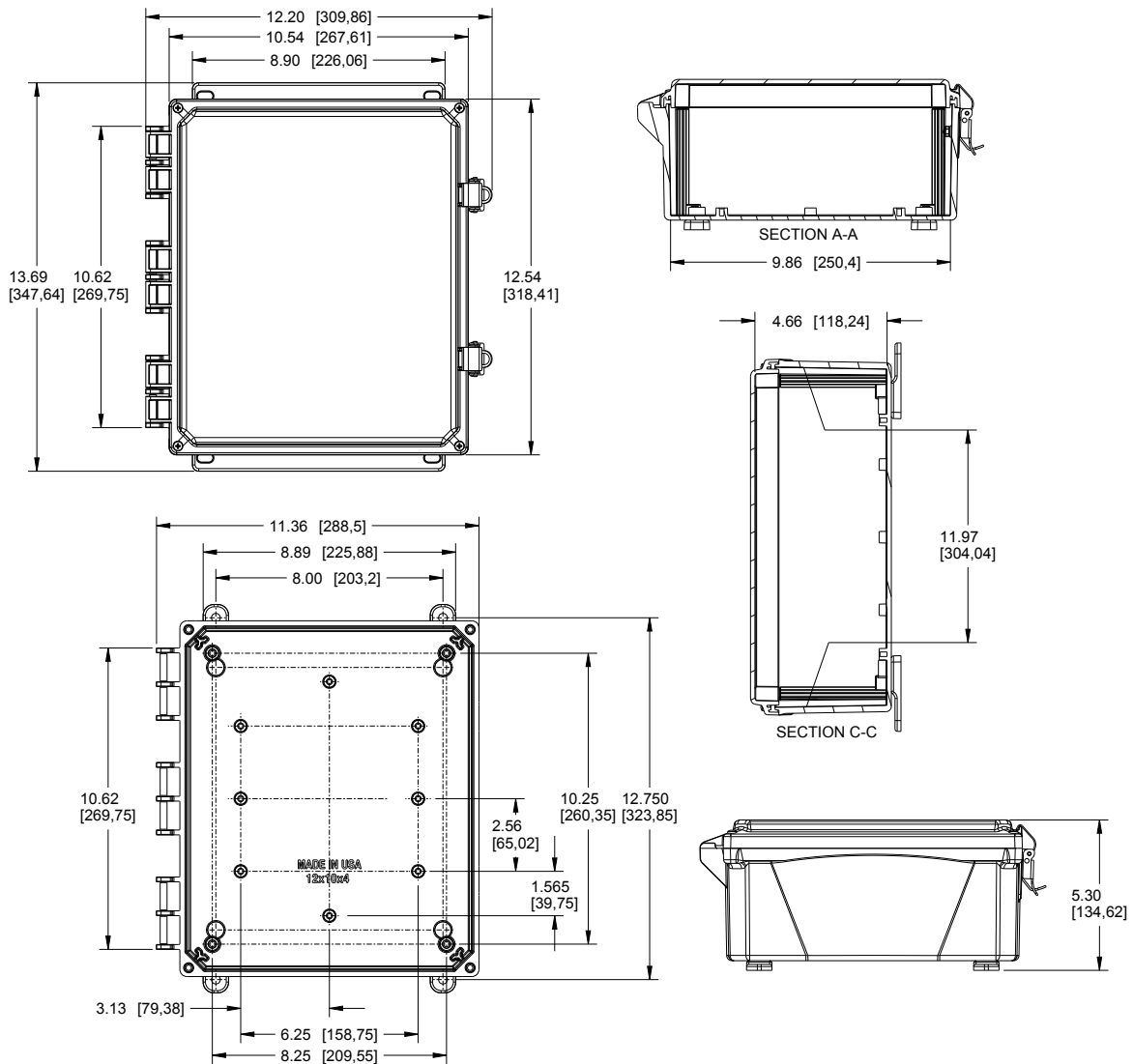





# 12X10X4 PREMIUM SERIES

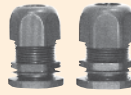

[Bracketed measurements in mm] Register online to download this drawing at [www.integraenclosures.com](http://www.integraenclosures.com)

## Accessories for 12x10x4 (For complete accessories, see pages 75-79)

 <p><b>Back Panels</b>  <b>ABP1210</b> - Aluminum panel  <b>SBP1210</b> - Steel panel  <b>PVCBP1210</b> - PVC panel</p>	 <p><b>Aluminum Swing Out Panels</b>  <b>ABP-1210-USOPK</b> - Complete panel kit  <b>ABP-1210USP</b> - Aluminum swing out panels only  <b>USOPK</b> - Hardware only</p>	 <p><b>Back Panel Adjustment Kit</b>  <b>BPAKG</b> - Gray, Set Screw  <b>BPAKB</b> - Black, Set Screw  <b>UBPAKG</b> - Gray, Thumb Screw  <b>UBPAKB</b> - Black Thumb Screw</p>
 <p><b>Air Vents / Fan Shrouds</b>  <b>VENT 3</b> - Aluminum louvered  <b>VENT 2</b> - Outdoor labyrinth  <b>FS KIT1</b> - 1 piece kit  <b>FS KIT2</b> - 2 piece kit</p>	 <p><b>Steel Swing Out Panels</b>  <b>SBP-1210-USOPK</b> - Complete panel kit  <b>SBP-1210USP</b> - Steel swing out panels only  <b>USOPK</b> - Hardware only</p>	 <p><b>Cord Grips</b>  IP68/NEMA 4X/6P rated  See page 72 for more details and part numbers.</p>
 <p><b>Din Rail</b>  <b>DIN 10</b> - 2 rails, 4 screws</p>	 <p><b>Pole Mounting Kit</b>  <b>PMKG-210</b> - 2" pole  <b>PMKG-310</b> - 3" pole  <b>PMKG-410</b> - 4" pole  <b>PMKG-1210</b> - 12" pole</p>	 <p><b>Mounting Feet &amp; Flange Kits</b>  <b>MFKG</b> - Premium line feet  <b>MFKSS</b> - Stainless steel feet  <b>MFLK10</b> - 10" Flange kit</p>