

Features

- N channel
- Enhancement mode
- Temperature sensor with thyristor characteristic
- The drain pin is electrically shorted to the tab

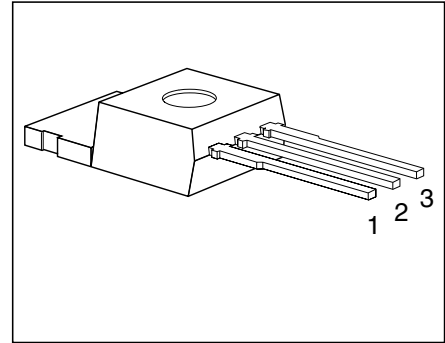

Pin	1	2	3
	G	D	S

Type	V_{DS}	I_D	$R_{DS(on)}$	Package	Ordering Code
BTS 129	60 V	27 A	0.05 Ω	TO-220AB	C67078-A5013-A2

Maximum Ratings

Parameter	Symbol	Values	Unit
Drain-source voltage	V_{DS}	60	V
Drain-gate voltage, $R_{GS} = 20 \text{ k}\Omega$	V_{DGR}	60	
Gate-source peak voltage, aperiodic	V_{gs}	± 20	
Continuous drain current, $T_C = 25 \text{ }^\circ\text{C}$	I_D	27	A
ISO drain current $T_C = 85 \text{ }^\circ\text{C}$, $V_{GS} = 10 \text{ V}$, $V_{DS} = 0.5 \text{ V}$	I_{D-ISO}	7.5	
Pulsed drain current, $T_C = 25 \text{ }^\circ\text{C}$	$I_{D \text{ puls}}$	108	
Short circuit current, $T_j = -55 \dots +150 \text{ }^\circ\text{C}$	I_{SC}	80	
Short circuit dissipation, $T_j = -55 \dots +150 \text{ }^\circ\text{C}$	P_{SCmax}	1200	W
Power dissipation	P_{tot}	75	
Operating and storage temperature range	T_j, T_{stg}	$-55 \dots +150$	$^\circ\text{C}$
DIN humidity category, DIN 40 040	–	E	–
IEC climatic category, DIN IEC 68-1	–	55/150/56	
Thermal resistance			K/W
Chip-case	$R_{th \text{ JC}}$	≤ 1.67	
Chip-ambient	$R_{th \text{ JA}}$	≤ 75	

Electrical Characteristics

 at $T_j = 25\text{ °C}$, unless otherwise specified.

Parameter	Symbol	Values			Unit
		min.	typ.	max.	

Static Characteristics

Drain-source breakdown voltage $V_{GS} = 0, I_D = 0.25\text{ mA}$	$V_{(BR)DSS}$	60	–	–	V
Gate threshold voltage $V_{GS} = V_{DS}, I_D = 1\text{ mA}$	$V_{GS(th)}$	2.5	3.0	3.5	
Zero gate voltage drain current $V_{GS} = 0\text{ V}, V_{DS} = 60\text{ V}$ $T_j = 25\text{ °C}$ $T_j = 150\text{ °C}$	I_{DSS}	– –	1 100	10 300	μA
Gate-source leakage current $V_{GS} = 20\text{ V}, V_{DS} = 0$ $T_j = 25\text{ °C}$ $T_j = 150\text{ °C}$	I_{GSS}	– –	10 2	100 4	nA μA
Drain-source on-state resistance $V_{GS} = 10\text{ V}, I_D = 17\text{ A}$	$R_{DS(on)}$	–	0.04	0.05	Ω

Dynamic Characteristics

Forward transconductance $V_{DS} \geq 2 \times I_D \times R_{DS(on)max}, I_D = 17\text{ A}$	g_{fs}	8.0	13.0	18.0	S
Input capacitance $V_{GS} = 0, V_{DS} = 25\text{ V}, f = 1\text{ MHz}$	C_{iss}	700	940	1250	pF
Output capacitance $V_{GS} = 0, V_{DS} = 25\text{ V}, f = 1\text{ MHz}$	C_{oss}	–	500	750	
Reverse transfer capacitance $V_{GS} = 0, V_{DS} = 25\text{ V}, f = 1\text{ MHz}$	C_{rss}	–	180	270	
Turn-on time t_{on} , ($t_{on} = t_{d(on)} + t_r$) $V_{CC} = 30\text{ V}, V_{GS} = 10\text{ V}, I_D = 3\text{ A}, R_{GS} = 50\text{ }\Omega$	$t_{d(on)}$	–	25	40	ns
	t_r	–	60	90	
Turn-off time t_{off} , ($t_{off} = t_{d(off)} + t_f$) $V_{CC} = 30\text{ V}, V_{GS} = 10\text{ V}, I_D = 3\text{ A}, R_{GS} = 50\text{ }\Omega$	$t_{d(off)}$	–	100	130	
	t_f	–	75	95	

Electrical Characteristics (cont'd)

 at $T_j = 25\text{ °C}$, unless otherwise specified.

Parameter	Symbol	Values			Unit
		min.	typ.	max.	

Reverse Diode

Continuous source current	I_S	–	–	27	A
Pulsed source current	I_{SM}	–	–	108	
Diode forward on-voltage $I_F = 27\text{ A}$, $V_{GS} = 0\text{ V}$	V_{SD}	–	1.3	1.8	V
Reverse recovery time $I_F = I_S$, $di_F/dt = 100\text{ A}/\mu\text{s}$, $V_R = 30\text{ V}$	t_{rr}	–	150	–	ns
Reverse recovery charge $I_F = I_S$, $di_F/dt = 100\text{ A}/\mu\text{s}$, $V_R = 30\text{ V}$	Q_{rr}	–	1.0	–	μC

Temperature Sensor

Forward voltage $I_{TS(on)} = 10\text{ mA}$, $T_j = -55 \dots +150\text{ °C}$ Sensor override, $t_p \leq 100\text{ }\mu\text{s}$ $T_j = -55 \dots +160\text{ °C}$	$V_{TS(on)}$	0.7	1.4	1.5	V
Forward current $T_j = -55 \dots +150\text{ °C}$ Sensor override, $t_p \leq 100\text{ }\mu\text{s}$ $T_j = -55 \dots +160\text{ °C}$	$I_{TS(on)}$	–	–	10	
Holding current, $V_{TS(off)} = 5\text{ V}$, $T_j = 25\text{ °C}$ $T_j = 150\text{ °C}$	I_H	0.05 0.05	0.1 0.2	0.5 0.3	mA
Switching temperature $V_{TS} = 5\text{ V}$	$T_{TS(on)}$	150	–	–	
Turn-off time $V_{TS} = 5\text{ V}$, $I_{TS(on)} = 2\text{ mA}$	t_{off}	0.5	–	2.5	μs

Examples for short-circuit protection

 at $T_j = -55 \dots +150 \text{ }^\circ\text{C}$, unless otherwise specified.

Parameter	Symbol	Examples			Unit
		1	2	–	
Drain-source voltage	V_{DS}	15	30	–	V
Gate-source voltage	V_{GS}	8.1	5.9	–	
Short-circuit current	I_{SC}	≤ 80	≤ 37	–	A
Short-circuit dissipation	P_{SC}	1200	1100	–	W
Response time $T_j = 25 \text{ }^\circ\text{C}$, before short circuit	$t_{SC(off)}$	25	25	–	ms

Short-circuit protection $I_{SC} = f(V_{DS})$

 Parameter: V_{GS}

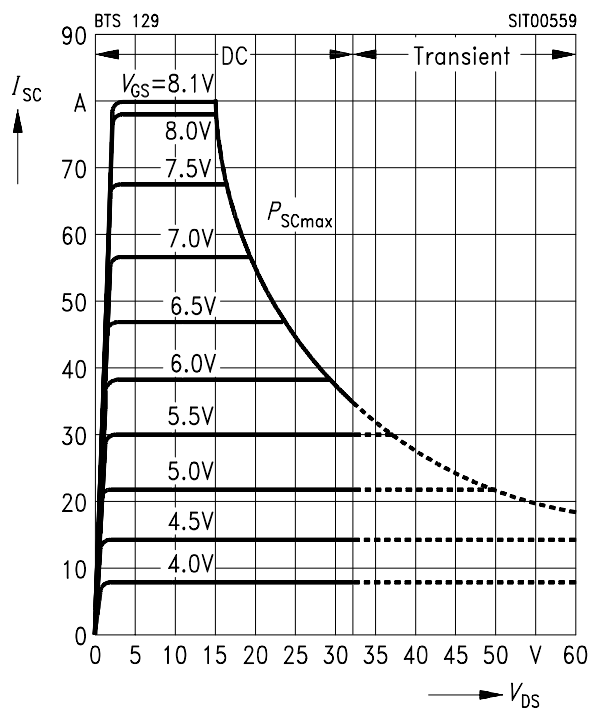
 Diagram to determine I_{SC} for $T_j = -55 \dots +150 \text{ }^\circ\text{C}$

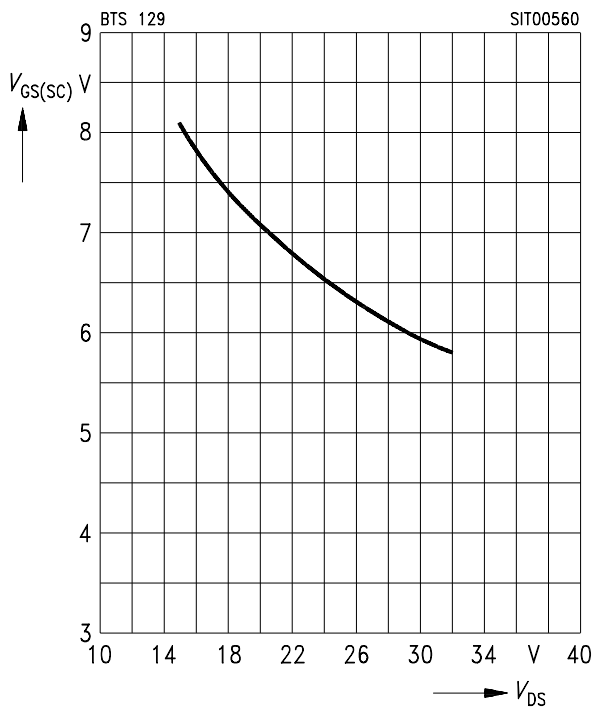
Max. gate voltage $V_{GS(SC)} = f(V_{DS})$

 Parameter: $T_j = -55 \dots +150 \text{ }^\circ\text{C}$

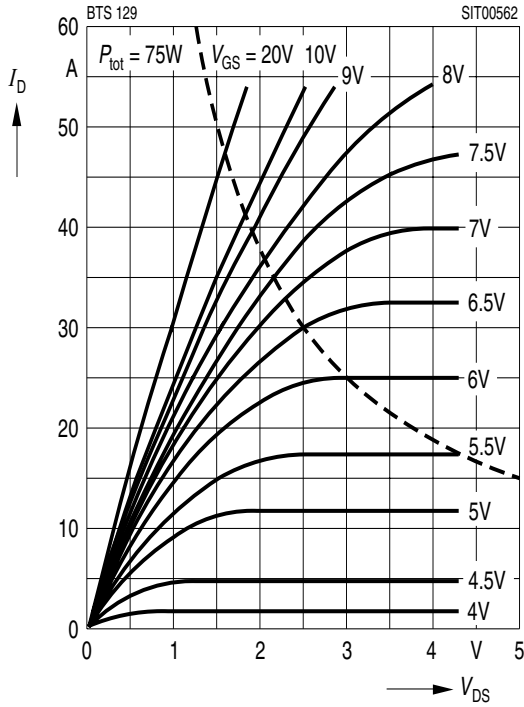
Typical output characteristics $I_D = f(V_{DS})$
 Parameter: $t_p = 80 \mu s$

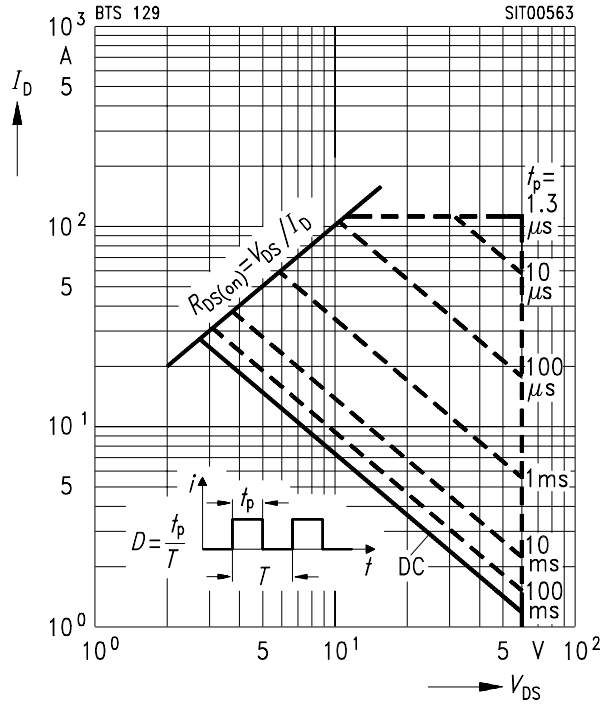

Safe operating area $I_D = f(V_{DS})$
 Parameter: $D = 0.01$, $T_C = 25^\circ C$



Typ. drain-source on-state resistance
 $R_{DS(on)} = f(I_D)$
 Parameter: V_{GS}

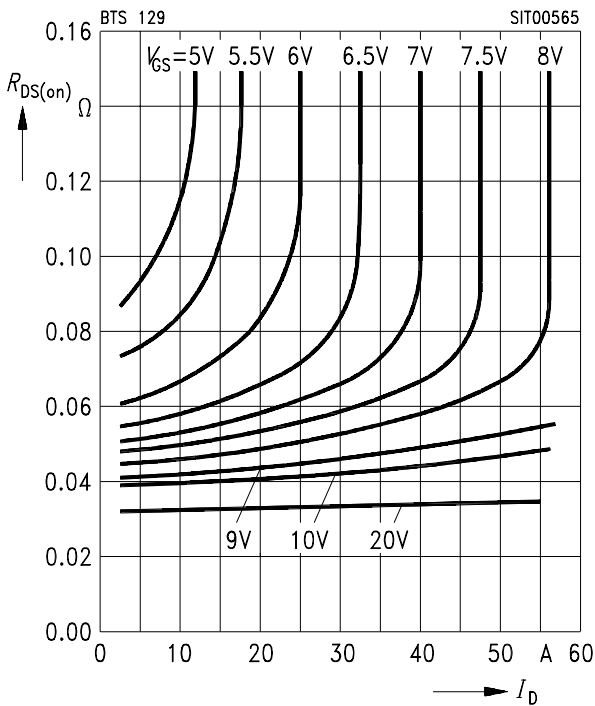

Drain-source on-state resistance
 $R_{DS(on)} = f(T_j)$
 Parameter: $I_D = 17 A$, $V_{GS} = 10 V$ (spread)

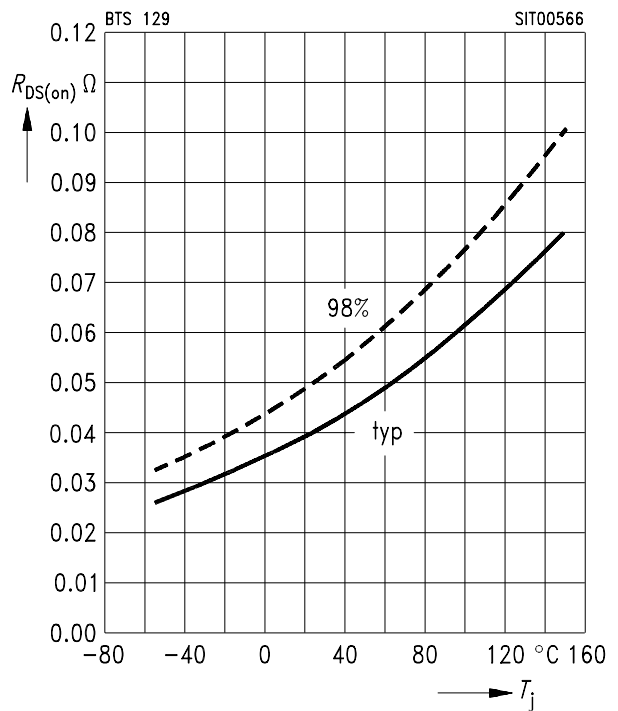

Typ. transfer characteristic

$I_D = f(V_{GS})$

Parameter: $t_p = 80 \mu s$, $V_{DS} = 25 V$

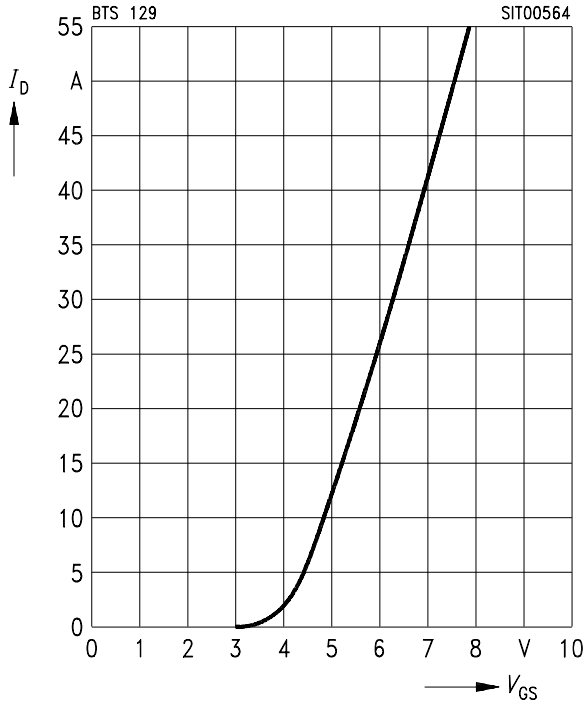

Typ. transconductance $g_{fs} = f(I_D)$

Parameter: $t_p = 80 \mu s$, $V_{DS} = 25 V$

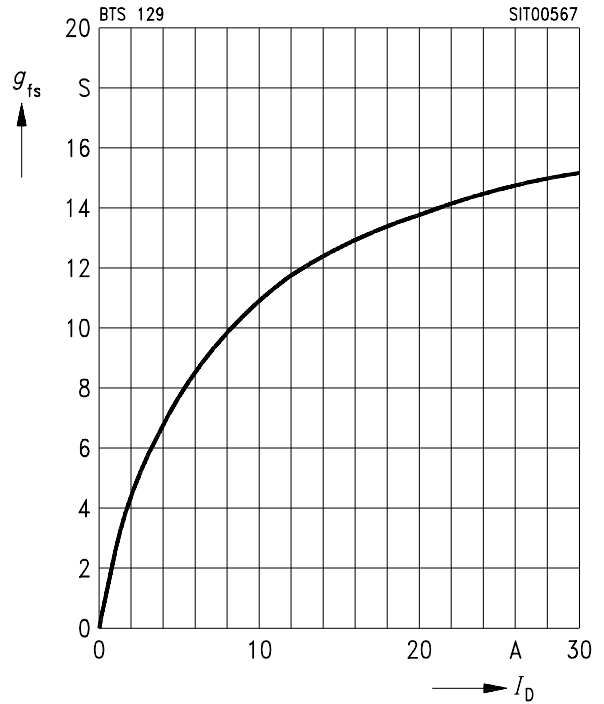

Gate threshold voltage $V_{GS(th)} = f(T_j)$

Parameter: $V_{DS} = V_{GS}$, $I_D = 1 mA$

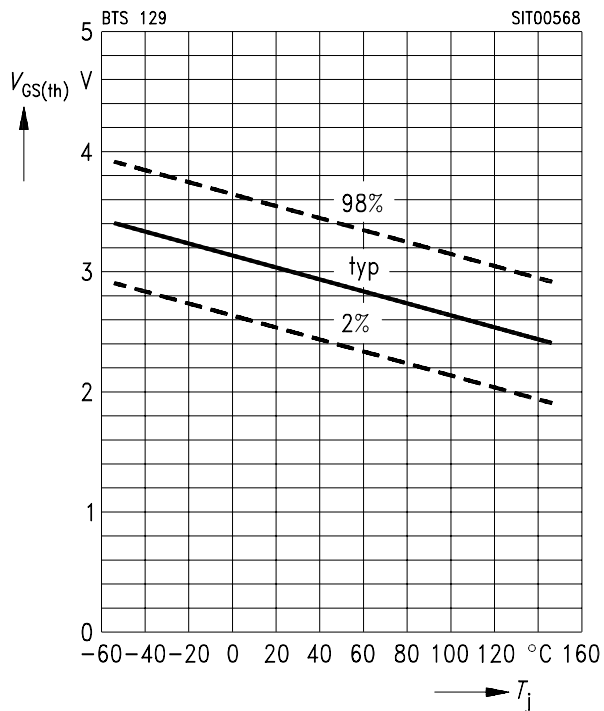

Continuous drain current $I_D = f(T_c)$

Parameter: $V_{GS} \geq 10 V$

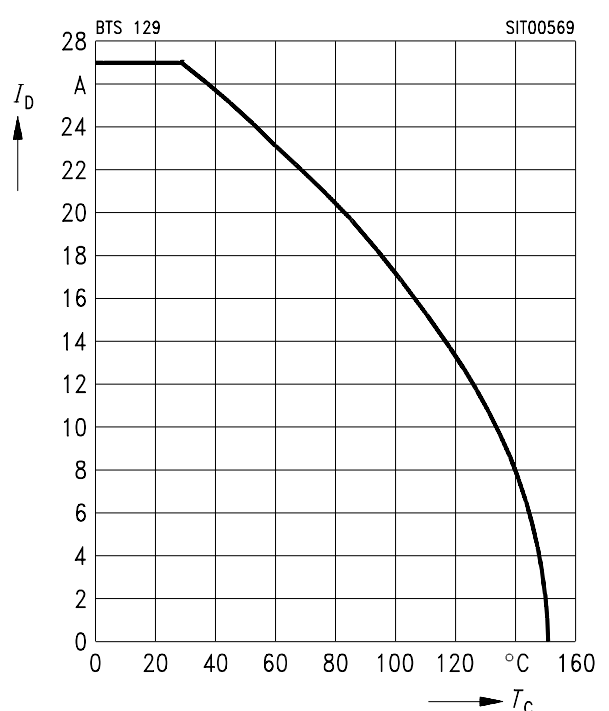

Typ. gate-source leakage current

$I_{GSS} = f(T_C)$

Parameter: $V_{GS} = 20\text{ V}$, $V_{DS} = 0$

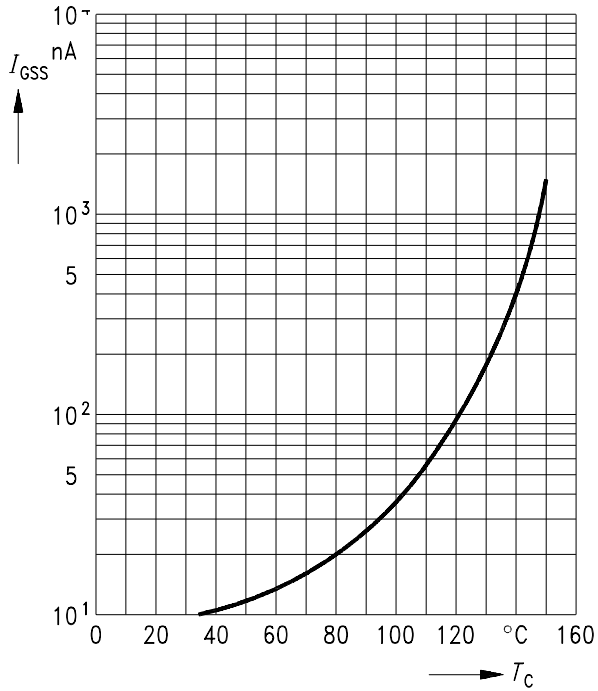

Typ. capacitances $C = f(V_{DS})$

Parameter: $V_{GS} = 0$, $f = 1\text{ MHz}$

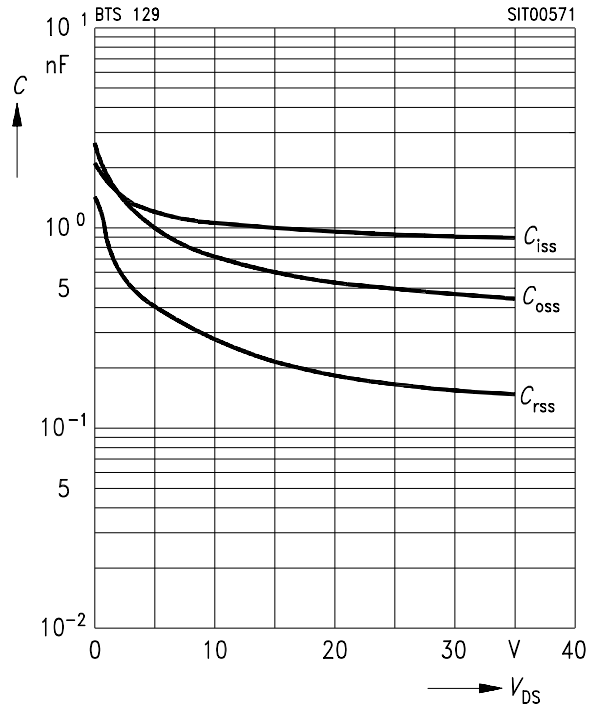

Forward characteristics of reverse diode

$I_F = f(V_{SD})$

Parameter: $T_j, t_p = 80\ \mu\text{s}$

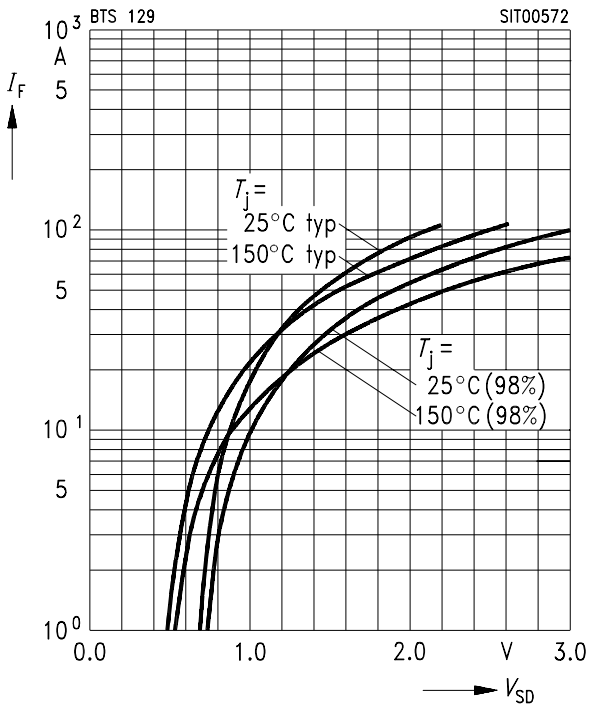

Transient thermal impedance $Z_{thJC} = f(t_p)$

Parameter: $D = t_p/T$

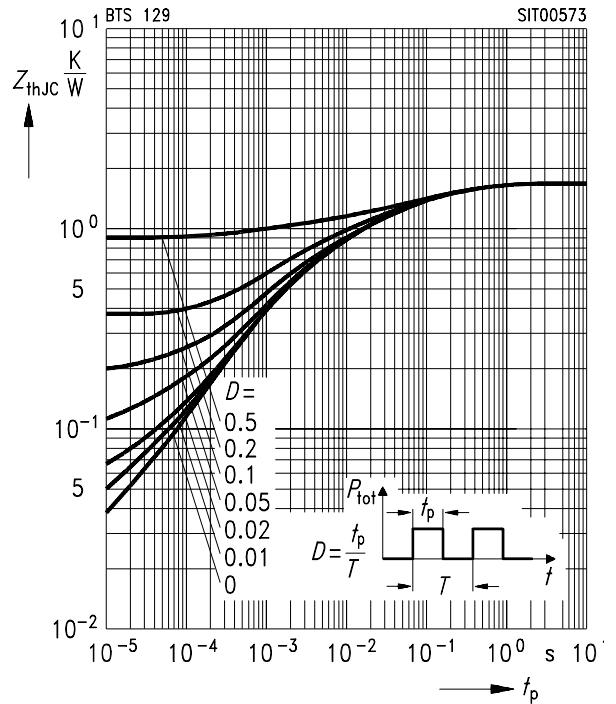

TO 220 AB
Standard

Ordering Code
C67078-A5013-A2

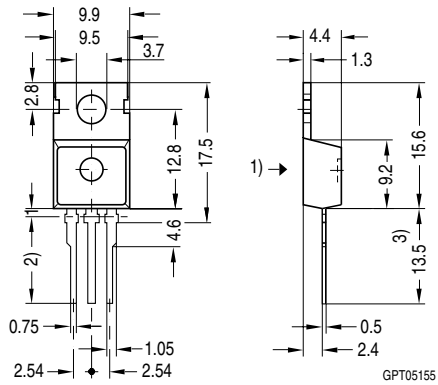

- 1) punch direction, burr max. 0.04
- 2) dip tinning
- 3) max. 14.5 by dip tinning press burr max. 0.05

Edition 04.97

**Published by Infineon Technologies AG,
St.-Martin-Strasse 53,
D-81541 München, Germany**

**© Infineon Technologies AG 2000.
All Rights Reserved.**

Attention please!

The information herein is given to describe certain components and shall not be considered as warranted characteristics.

Terms of delivery and rights to technical change reserved.

We hereby disclaim any and all warranties, including but not limited to warranties of non-infringement, regarding circuits, descriptions and charts stated herein.

Infineon Technologies is an approved CECC manufacturer.

Information

For further information on technology, delivery terms and conditions and prices please contact your nearest Infineon Technologies Office in Germany or our Infineon Technologies Representatives worldwide (see address list).

Warnings

Due to technical requirements components may contain dangerous substances. For information on the types in question please contact your nearest Infineon Technologies Office.

Infineon Technologies Components may only be used in life-support devices or systems with the express written approval of Infineon Technologies, if a failure of such components can reasonably be expected to cause the failure of that life-support device or system, or to affect the safety or effectiveness of that device or system. Life support devices or systems are intended to be implanted in the human body, or to support and/or maintain and sustain and/or protect human life. If they fail, it is reasonable to assume that the health of the user or other persons may be endangered.